

# **A Brief Review of Wave Energy**

A report produced for The UK Department of Trade and  
Industry

T W Thorpe

May 1999

# A Brief Review of Wave Energy

---

A report produced for The UK Department of Trade and  
Industry

T W Thorpe

May 1999

---

<b>Title</b>	A Brief Review of Wave Energy
<b>Customer</b>	The UK Department of Trade and Industry
<b>Customer reference</b>	
<b>Confidentiality, copyright and reproduction</b>	<p>Restricted - Commercial</p> <p>This document has been prepared by AEA Technology plc in connection with a contract to supply goods and/or services and is submitted only on the basis of strict confidentiality. The contents must not be disclosed to third parties other than in accordance with the terms of the contract.</p>
<b>Report number</b>	ETSU-R120
<b>Report status</b>	Final

B 154  
Harwell  
Didcot  
Oxfordshire  
OX11 0RA  
UK  
Telephone +44 (0)1235 433043  
Facsimile +44 (0)1235 432948

AEA Technology is the trading name of AEA Technology plc  
AEA Technology is certificated to BS EN ISO9001:(1994)

	<b>Name</b>	<b>Signature</b>	<b>Date</b>
<b>Author</b>	T W Thorpe		19/4/1999
<b>Reviewed by</b>	R Meir		14/5/1999
<b>Approved by</b>	A Brown		24/5/1999

# Executive Summary

This report presents an overview of some of the main developments in wave energy since the DTI's earlier review in 1992. It concentrates on devices for which new data have been produced since the earlier review. However, the limited time and effort available for this review precluded independent verification of some of these data.

The DTI's earlier review of wave energy found that the optimistic expectations for the original wave energy devices were unfounded. Nevertheless, the same review methodology now indicates that wave energy could become a useful source of energy. The first commercial OWC schemes are expected to be deployed in the next few years, along with demonstration schemes for other technologies. However, the more promising offshore devices are still at the assessment stage.

## The UK Wave Energy Resource

The total amount of wave power in the sea around the British Isles (including Eire) has been estimated at an annual average of 120 GW (ETSU, 1985). The amount of this deep water resource that could be turned into useful energy is given in Table ES.1. These represent conservative values, incorporating the likely technical, economic and environmental constraints identified in this report.

**Table ES.1 The UK Wave Energy Resource**

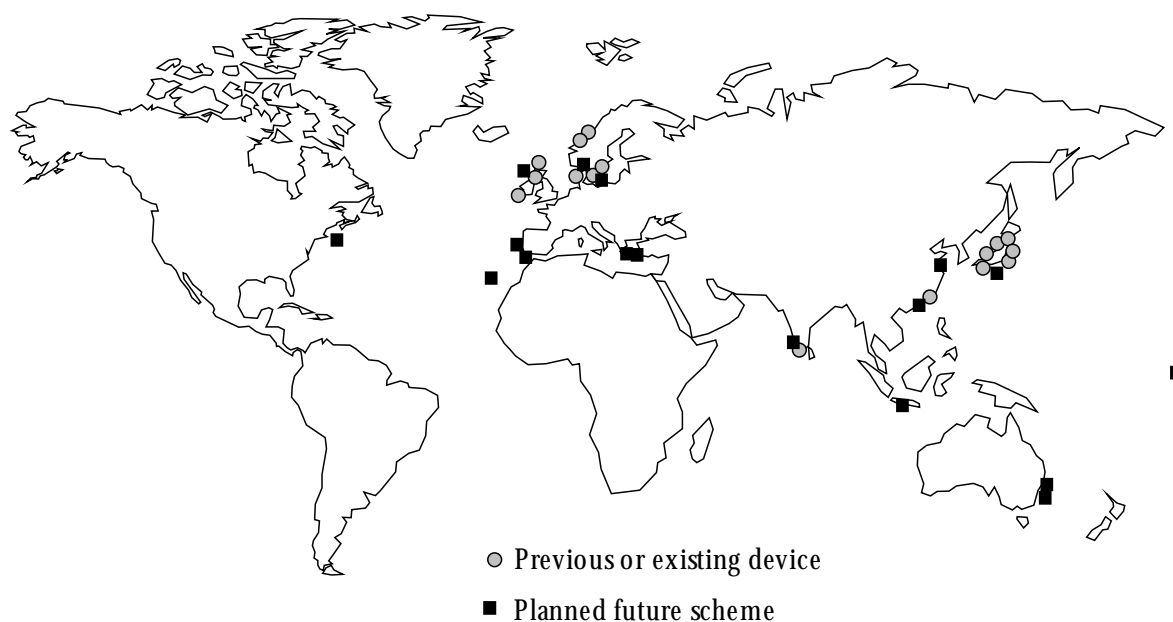
<b>Location</b>	<b>Annual Energy Production (TWh)</b>
Shoreline	0.4
Nearshore*	2.1
Offshore	50

Key. \* = includes contribution from wind turbine in OSPREY devices.

## The Technical Status Of Wave Energy

The technical status of the devices covered in this Review varies widely. Some are already being built as full-scale prototype or demonstration schemes, whilst others still require years of further research. Many of the potential problem areas identified in the earlier review have been addressed by design improvements. However, it is necessary for all wave energy devices to prove their long term reliability and performance as full size schemes.

Within the UK, there are three devices that are likely to be built in the near future as part of the Scottish Renewables Order. Other countries with much less energetic wave regimes have either already deployed wave energy schemes or are planning to deploy them soon (Figure ES.1).

**Figure ES.1 Distribution of Wave Energy Schemes**

Most of the schemes shown in this Figure are oscillating water columns, which are first generation devices. This technology should be classified as being in the demonstration stage. Other technologies that could fit into that category include the Japanese Pendulor and the Tapchan, whilst there are several other devices where demonstration schemes are currently being built (e.g. the McCabe Wave Pump and the OPT Wave Energy Converter).

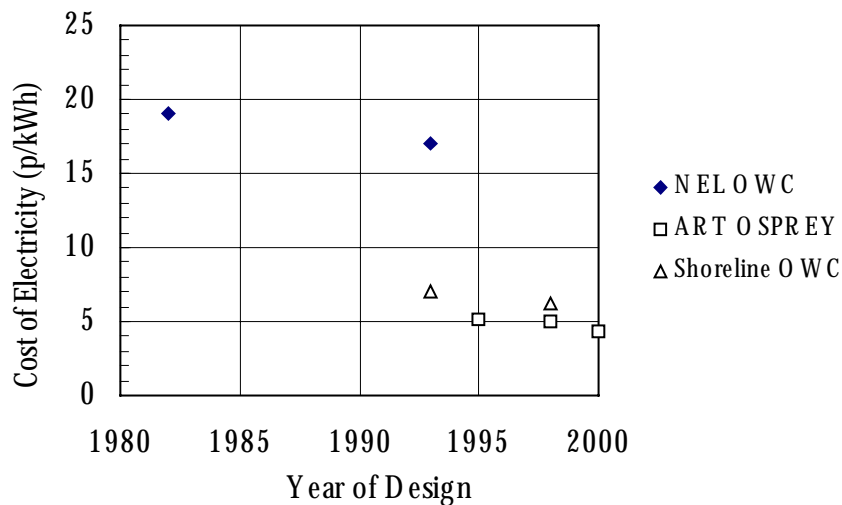
The next generation of devices comprises new, modular floating devices (such as those described in Chapter 6 of this report) but these require further research and/or demonstration.

### The Economic Status Of Wave Energy

There has been a significant improvement in the predicted economics of wave energy, so that there are now several with costs of  $\sim 5$  p/kWh or less at 8% discount rate, if the devices achieve their predicted performance (Figures ES.2 and ES.3). This indicates that, if these devices can be successfully built and operated, wave energy is already economically competitive in niche markets such as supplying electricity to isolated communities that are not connected to the grid. It has good prospects of being more commercially competitive with further R&D.

It should be emphasised that there is considerable uncertainty associated with some of these estimates, because of the lack of important information and in-service data. An approximate estimate of the uncertainties associated with the different aspects of wave energy schemes indicates that predicted generating costs could vary by up to  $\pm 20\%$  about the median value. However, in-service experience is required on full size scheme to provide greater confidence in such predictions.

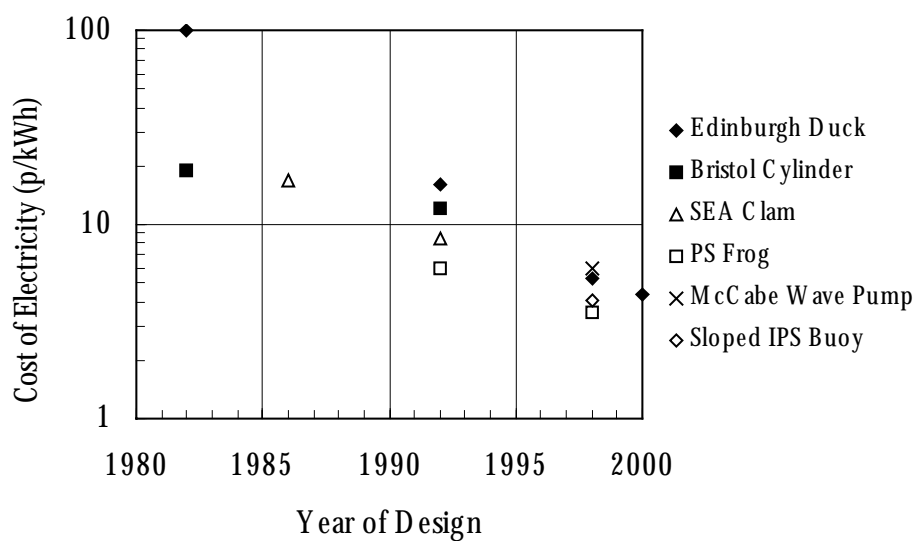
**Figure ES.2 Evolution of Predicted Electricity Costs for OWCs\***



Key. \* at 8% discount rate.

Costs for year 2000 design incorporate improvements already quantified.

**Figure ES.3 Evolution of Predicted Electricity Costs for Offshore Devices\***



Key. \* at 8% discount rate.

Costs for year 2000 design incorporate improvements already quantified.

**The UK Market**

The activities described in this report are expected to result in the deployment around the UK of about 3 MW of full-size wave energy devices in the next few years. The current round of the Scottish Renewables Order (SRO) could add to this capacity.

The deployment of wave energy schemes beyond this date will depend on the technical performance and reliability of the first commercial schemes. If wave energy devices do achieve their predicted costs and performance, they could generate up to 50 TWh/year in the UK, corresponding to an investment of about £ 20 billion.

**Export Potential**

There are well-advanced plans for the world-wide deployment of about 6 MW of wave energy devices in the next few years. An evaluation of wave power levels around the world undertaken as part of this review indicates a global resource of more than 1 TW. An assessment of the likely market indicates that, if wave energy devices perform as predicted their economic contribution would be > 2,000 TWh per year. This would correspond to an investment of more than £ 500 billion.

**The Prospects for Wave Energy**

This report notes a number of practical obstacles to the deployment of near market technologies: planning procedures, lack of relevant design codes, high grid connection charges, etc. Therefore, financial support will probably be required by the first prototypes and in developing overseas markets. Those areas requiring further R&D (especially by the longer term, offshore devices) are identified. The importance of the forthcoming demonstration schemes concentrating on survivability and reliability, rather than achieving economic competitiveness is emphasised.

# Contents

<b>1</b>	<b>INTRODUCTION .....</b>	<b>1</b>
1.1	BACKGROUND TO THE REVIEW .....	1
1.2	OUTLINE OF THE REPORT .....	2
<b>2</b>	<b>ASSESSMENT METHODOLOGY .....</b>	<b>5</b>
2.1	INTRODUCTION .....	5
2.2	ECONOMIC ASSESSMENT .....	5
2.2.1	Wave Energy Resource .....	5
2.2.2	Capital Costs .....	16
2.2.3	Availability .....	17
2.2.4	Operation and Maintenance Costs .....	17
2.2.5	Electrical Output .....	18
2.2.6	Determination of Annual Costs .....	19
<b>3</b>	<b>SHORELINE WAVE ENERGY - THE LIMPET .....</b>	<b>21</b>
3.1	INTRODUCTION .....	21
3.2	DESCRIPTION OF THE LIMPET .....	21
3.2.1	The Structure .....	22
3.3	ASSESSMENT OF THE LIMPET .....	24
3.3.1	Technical Considerations .....	24
3.3.2	Replication Potential .....	24
3.4	ECONOMIC ASSESSMENT OF THE LIMPET .....	25
3.4.1	Capital Cost .....	25
3.4.2	Operational and Maintenance Costs .....	25
3.4.3	Electrical Output .....	25
3.4.4	Generating Costs .....	26
3.4.5	Internal Rate of Return .....	26
3.5	RESOURCE-COST CURVES .....	27
3.6	SCOPE FOR IMPROVEMENT .....	28
<b>4</b>	<b>NEARSHORE WAVE ENERGY - THE OSPREY .....</b>	<b>31</b>
4.1	A BRIEF HISTORY OF THE DEVICE .....	31
4.2	THE STEEL OSPREY .....	31
4.3	THE CONCRETE OSPREY .....	33



4.3.1	Outline Description.....	33
4.3.2	Summary of the Technical Evaluation.....	35
<b>4.4</b>	<b>THE WIND TURBINE.....</b>	<b>36</b>
<b>4.5</b>	<b>ECONOMIC ASSESSMENT OF THE OSPREY OWC.....</b>	<b>36</b>
4.5.1	Capital Costs.....	37
4.5.2	Availability Of The OSPREY.....	37
4.5.3	Operational and Maintenance Costs .....	38
4.5.4	Annual Output of the OWC .....	39
4.5.5	Summary of the Annual Output of the OWC.....	45
4.5.6	Output from the Wind Turbines.....	45
4.5.7	Generating Costs.....	46
4.5.8	Internal Rate of Return .....	47
<b>4.6</b>	<b>RESOURCE-COST CURVES .....</b>	<b>48</b>
<b>4.7</b>	<b>POTENTIAL COST REDUCTIONS .....</b>	<b>50</b>
<b>5</b>	<b>OFFSHORE WAVE ENERGY - THE DUCK .....</b>	<b>53</b>
<b>5.1</b>	<b>INTRODUCTION.....</b>	<b>53</b>
<b>5.2</b>	<b>THE 1983 DUCK .....</b>	<b>53</b>
5.2.1	Assessment of the 1983 Duck.....	56
<b>5.3</b>	<b>THE 1991 DUCK .....</b>	<b>57</b>
5.3.1	Outline of the Changes to the 1983 Duck.....	58
5.3.2	Implications of Changes to the Duck.....	59
<b>5.4</b>	<b>THE 1998 DUCK .....</b>	<b>59</b>
5.4.1	Transmission Cabling .....	59
5.4.2	Power Take-off.....	60
5.4.3	Spine Joints.....	62
<b>5.5</b>	<b>TECHNICAL COMMENTS ON THE 1998 DUCK.....</b>	<b>63</b>
5.5.1	Civil Structure.....	63
5.5.2	Mechanical and Electrical Plant .....	66
5.5.3	Transmission System .....	66
5.5.4	Transportation and Installation .....	67
5.5.5	Summary of Technical Comments.....	67
<b>5.6</b>	<b>ECONOMIC ASSESSMENT OF THE 1998 DUCK.....</b>	<b>68</b>
5.6.1	Capital Cost .....	68
5.6.2	Operating and Maintenance Costs of the 1998 Duck.....	68
5.6.3	Electrical Output from the 1998 Duck.....	68
5.6.4	Generating Costs for the 1998 Duck.....	71
5.6.5	Internal Rate of Return for the 1998 Duck .....	72
<b>5.7</b>	<b>RESOURCE-COST CURVES FOR THE 1998 DUCK.....</b>	<b>74</b>
<b>5.8</b>	<b>POTENTIAL COST REDUCTIONS .....</b>	<b>74</b>
<b>6</b>	<b>NEW DEVICES .....</b>	<b>77</b>

<b>6.1</b>	<b>THE PS FROG .....</b>	<b>77</b>
6.1.1	Background.....	77
6.1.2	Outline of the PS Frog .....	77
6.1.3	Economic Assessment of the PS Frog .....	81
<b>6.2</b>	<b>THE MCCABE WAVE PUMP .....</b>	<b>87</b>
6.2.1	Description of the Device .....	87
6.2.2	Economic Assessment of the MWP .....	87
<b>6.3</b>	<b>THE SLOPED IPS BUOY .....</b>	<b>94</b>
6.3.1	Description of the Device .....	94
6.3.2	Economic Assessment of the Sloped IPS Buoy .....	96
<b>6.4</b>	<b>SUMMARY .....</b>	<b>99</b>
<b>7</b>	<b>OVERSEAS ACTIVITIES .....</b>	<b>102</b>
<b>7.1</b>	<b>SHORELINE DEVICES .....</b>	<b>102</b>
7.1.1	Oscillating Water Column (OWC) Devices.....	102
7.1.2	Tapered Channel Devices (TAPCHAN).....	104
7.1.3	The Pendulor Device .....	105
<b>7.2</b>	<b>OFFSHORE DEVICES .....</b>	<b>105</b>
7.2.1	Float-Based Devices .....	105
7.2.2	Pneumatic Devices.....	107
7.2.3	Moving Body Devices .....	107
7.2.4	Hydroelectric Devices .....	108
<b>7.3</b>	<b>RECENT INTERNATIONAL WAVE ENERGY ACTIVITIES .....</b>	<b>108</b>
7.3.1	The European Wave Energy Programme.....	108
7.3.2	The Indian Wave Energy Programme.....	109
7.3.3	The Japanese Wave Energy Programme.....	109
7.3.4	Other Wave Energy Activities .....	109
<b>8</b>	<b>ENVIRONMENTAL IMPACTS OF WAVE ENERGY .....</b>	<b>112</b>
<b>8.1</b>	<b>POTENTIAL IMPACTS .....</b>	<b>112</b>
8.1.1	Hydrodynamic Environment.....	112
8.1.2	Devices as Artificial Habitats .....	113
8.1.3	Noise.....	114
8.1.4	Navigational Hazards.....	114
8.1.5	Visual Effects.....	115
8.1.6	Leisure Amenity.....	115
8.1.7	Device Construction .....	115
8.1.8	Conversion and Transmission of Energy .....	115
<b>8.2</b>	<b>ENVIRONMENTAL EFFECTS OF THE PROTOTYPE DEVICE .....</b>	<b>115</b>
<b>8.3</b>	<b>EMISSIONS .....</b>	<b>116</b>
8.3.1	Introduction .....	116
8.3.2	Life Cycle Stages for Wave Energy Technologies .....	116
8.3.3	Calculation of Life Cycle Emissions.....	117
<b>9</b>	<b>DISCUSSION .....</b>	<b>120</b>

<b>9.1</b>	<b>THE TECHNICAL STATUS OF WAVE ENERGY .....</b>	<b>120</b>
<b>9.2</b>	<b>THE ECONOMIC STATUS OF WAVE ENERGY .....</b>	<b>121</b>
9.2.1	Development of Predicted Generating Costs .....	121
9.2.2	Uncertainties in Predicted Generating Costs.....	124
<b>9.3</b>	<b>RESOURCE-COST CURVES .....</b>	<b>126</b>
9.3.1	The Natural Resource .....	126
9.3.2	The Technical Resource .....	126
9.3.3	Resource-Cost Curves.....	127
<b>9.4</b>	<b>THE COMMERCIAL STATUS OF WAVE ENERGY .....</b>	<b>128</b>
9.4.1	The UK Market.....	128
9.4.2	Export Potential .....	129
9.4.3	Industry Status .....	130
9.4.4	Financial Institutions.....	130
<b>9.5</b>	<b>THE PROSPECTS FOR WAVE ENERGY .....</b>	<b>130</b>
9.5.1	Early Demonstration Schemes .....	130
9.5.2	The Need for Further Research in the UK .....	131
<b>9.6</b>	<b>ADDITIONAL CONSIDERATIONS.....</b>	<b>132</b>
<b>9.7</b>	<b>CONCLUSION.....</b>	<b>132</b>
<b>10</b>	<b>REFERENCES .....</b>	<b>134</b>

# 1 Introduction

## 1.1 BACKGROUND TO THE REVIEW

The DTI's active support for wave energy was reduced in the early 1980s following its review of energy related RDD&D, which classified wave energy under "watching brief" (DEn, 1988). This category meant that the technology did not look economically competitive under a range of scenarios but that this situation would be re-evaluated in the light of any new developments. This decision was supported by an extensive review of wave energy (Thorpe, 1992), which concluded:

*.....the cost of electricity from the existing designs of wave energy devices is unlikely to be economically competitive in the short to medium term. However the above analyses of the cost of electricity generation from the Main Devices are a best attempt to assess the possible future status of these designs. They represent a snapshot of the status and costs of the designs at one stage in their development. No conventional analysis can assess the potential for the concepts behind the designs, where modifications could lead to changes in the practicality and economics of the devices. Discussions with the design teams have indicated that, in order to achieve significant reductions in the cost of electricity generation, most of the Main Devices would have to be substantially modified from the designs considered in this review. The main report outlines such proposals but these are mainly at an early stage and so their effect on the generating costs of the devices could not be quantified as part of this review.  
(Thorpe, 1992).*

A situation arose in 1994/5 when work carried out by Applied Research and Technology (now Wavegen) on their design for an oscillating water column device had brought about several advances, which could have affected the economics of wave energy. The DTI commissioned a review, which showed that Wavegen had reduced the cost of electricity generation from OWCs by over 60% (in comparison with design considered in the 1992 review), to a value of just over 6 p/kWh (Thorpe, 1995).

Since the cessation of Governmental support for wave energy, there has been considerable work undertaken both within the UK and overseas (Thorpe, 1998a). This work has produced a number of new device designs, as well as modifications of existing designs. An initial assessment (Thorpe, 1998a and 1998b) of these developments indicated that the predicted cost of electricity from wave energy devices had reduced significantly, so that several devices now had estimated generating costs of ~ 5 p/kWh (at 8% discount rate), with the potential for even lower generating costs in the future.

In the light of such developments and in keeping with the technology’s “watching brief” category, the DTI has commissioned a new review of the current status of wave energy, with particular emphasis on the developments since its previous review. This report present the main findings of that review.

It should be emphasised that this review was conducted over a relatively short time scale (one month) and, therefore, the results cannot be considered definitive. In particular:

- In many cases, predictions of device output are based on small-scale model tests or theoretical predictions, which have yet to be confirmed in full size devices.
- It has not been possibly to validate rigorously or peer review all of the new data on which this update is based.

## 1.2 OUTLINE OF THE REPORT

In order to set the technical context for the report, Chapter 2 presents the methodology used in this review.

Chapters 3 to 5 present a detailed assessment of three representative devices that were assessed in the earlier review but which have subsequently undergone considerable modification. These are outlined in Table 1.1.

**Table 1.1 Devices Assessed in the Review**

<b>Location or Type</b>	<b>Device</b>	<b>Features</b>
<b>Shoreline</b>	LIMPET OWC	Development from early prototype device on Islay
<b>Nearshore</b>	OSPREY OWC	Developed from the prototype deployed at Dounreay
<b>Offshore</b>	Duck	Developed from design assessed in 1992 review
<b>Small Floating</b>	Sloped IPS Buoy	Developed from design reviewed in 1992 review
<b>Small Floating</b>	McCabe Wave Pump	Being tested as a prototype
<b>Small Floating</b>	PS Frog	Developed from design assessed in 1992 review

One of the most significant developments since the earlier review is the evolution of small-scale floating devices, which have the potential to capture energy from a wave front that is larger than their physical dimensions (i.e. a high capture efficiency). Chapter 6 presents an evaluation of three representative devices (Table 1.1).

Wave energy research is being undertaken in many countries and it is impossible to evaluate all the progress made therein. Chapter 7 presents a brief overview of the principal activities. One of the main driving forces behind the development of wave energy (and other renewables) is their environmental benefits compared to conventional generation. However,

no energy producing technology is without environmental impacts. Chapter 8 presents a preliminary evaluation of the environmental implications of a representative wave energy device.

Chapter 9 includes a discussion of the main findings of the review, together with some suggestions as to the possible ways in which this technology could be taken forward.



## 2 Assessment Methodology

### 2.1 INTRODUCTION

The main devices considered in this report have been assessed both technically and economically.

- The assessment focuses on devices for which new data have been produced since the earlier review (Thorpe, 1992). The inputs to the assessment are based on data provided by the teams working on these devices, the most important being their estimates of the dimensions and performance of the devices and their major components. For the most part, it has not been possible to validate these data independently. Where appropriate, the relevant Sections on each device contain comments regarding technical feasibility and areas requiring further R&D.
- The clearest and simplest measure of the commercial viability of wave energy is probably the predicted cost of electricity produced by a wave energy station in terms of p/kWh (discounted over the lifetime of a device - typically 30 years). In deriving such a value a number of steps have to be taken, as outlined in Figure 2.1. Each of the aspects shown in this Figure is discussed below. Although some of these aspects are common to all devices and, as such, can be discussed in general terms under appraisal methodology, other aspects are device-specific and are discussed in the relevant sections on each device. Since there has been considerable debate about use of the common economic assessment methodology of discounted cash flow, this review also includes another commonly used assessment method: the internal rate of return (IRR).

### 2.2 ECONOMIC ASSESSMENT

#### 2.2.1 Wave Energy Resource

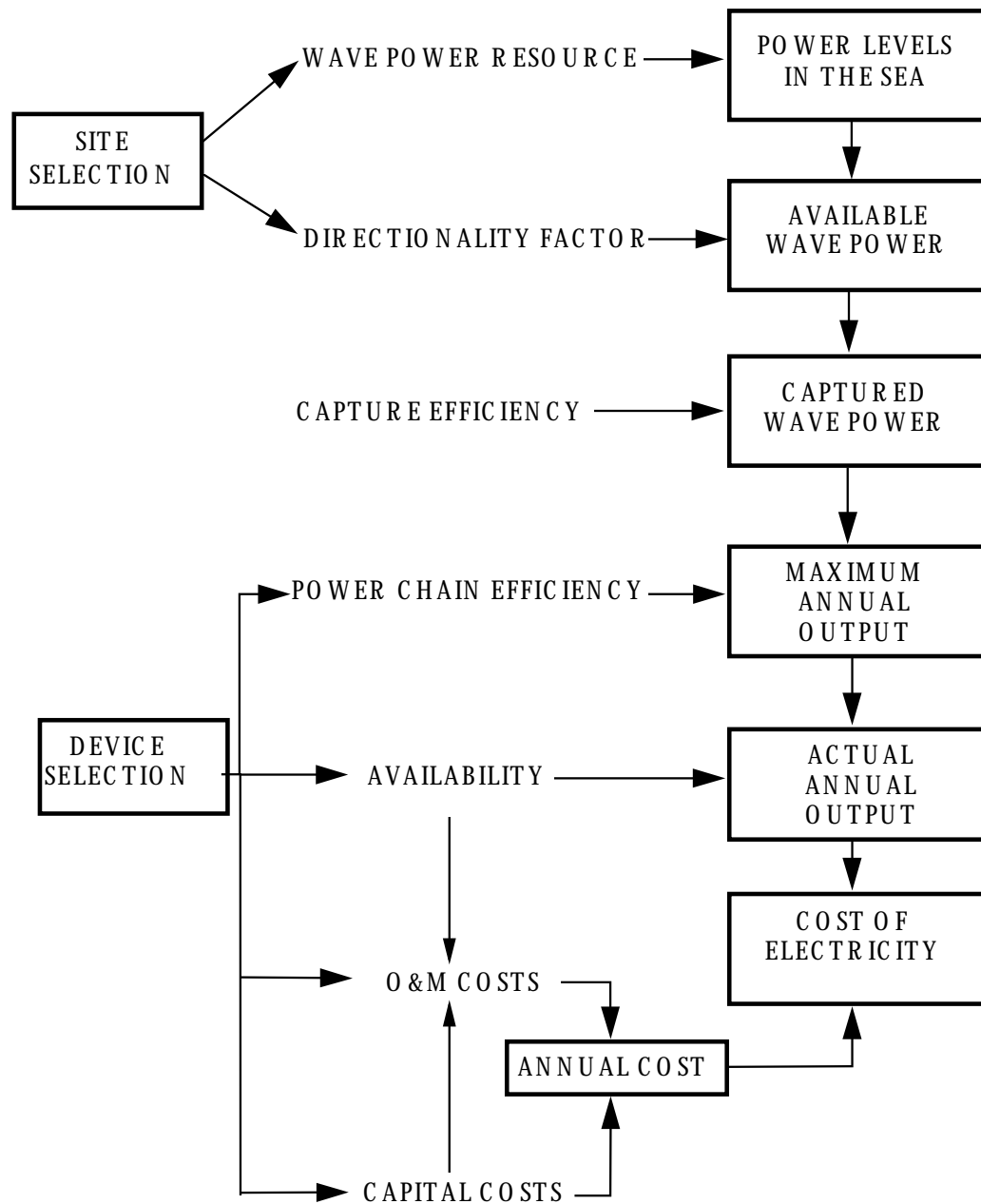
Wave energy can be considered as a concentrated form of solar energy. Winds are generated by the differential heating of the earth. As they pass over open bodies of water they transfer some of their energy to form waves (Southgate, 1987). The precise mechanisms involved in this transfer are complex and not yet completely understood.

Nevertheless, three main processes appear to be operating:

- Initially air flowing over the sea exerts a tangential stress on the water surface, resulting in the formation and growth of waves.
- Turbulent air flow close to the water surface creates rapidly varying shear stresses and pressure fluctuations. Where these oscillations are in phase with existing waves, further wave development occurs.



**Figure 2.1 Methodology for Economic Appraisal**



- Finally, when waves have reached a certain size, the wind can actually exert a stronger force on the upwind face of the wave causing additional wave growth. The process is maximised when the speeds of the wind and waves are equal.

Energy is transferred from the wind to the waves at each of these steps. Clearly, the amount of energy transferred, and hence the size of the resulting waves, depends on the wind speed, the length of time for which the wind blows and the distance over which it blows (the fetch). At each stage in the process, power is concentrated so that solar power levels of typically about  $100 \text{ W/m}^2$  can be eventually transformed into waves with power levels of over  $1,000 \text{ kW}$  per metre of crest length.

Waves lying within or close to the areas where they are generated, “storm waves”, produce a complex, irregular sea. These waves will continue to travel in the direction of their formation even after the wind dies down. In deep water, waves lose energy only slowly (mainly by interacting with the atmosphere), so they can travel out of the storm areas with minimal loss of energy as regular, smooth waves or “swell”. These can persist at great distances from the point of origin.

### Simple Wave Characteristics

#### *Deep Water Waves*

Water waves can be considered to travel along the surface of the sea with an approximate sinusoidal profile. They can be characterised (Southgate, 1981) in terms of the distance between successive crests (the wavelength,  $\lambda$ ) and the time between successive crests (the period,  $T$ ). In deep water these parameters are related as follows:

$$\lambda = \frac{gT^2}{2\pi} \quad \text{Eqn. 2.1}$$

where  $g$  is the acceleration due to gravity .

The velocity of the waves,  $C$ , is given by the following relationship:

$$C = \frac{\lambda}{T} \quad \text{Eqn. 2.2}$$

Hence, longer waves travel faster than shorter ones. This effect is seen in hurricane areas, where long waves generally travel faster than the storm generating them and so the arrival of the hurricane is often preceded by heavy surf on the coast.

The power ( $P$ ) in such waves can also be described by use of these parameters and the wave height,  $H$ :

$$P = \frac{\rho g^2 T H^2}{32 \pi} \quad \text{Eqn. 2.3}$$

where  $\rho$  is the density of sea water and  $P$  is expressed per unit crest length of the wave. Most of the energy within a wave is contained near the surface and falls off sharply with depth. Therefore, most wave energy devices are designed to float (or in the case of bottom standing devices to be in shallow water) and so pierce the water surface in order to maximise the energy available for capture.

### ***Shallow Water Waves***

As waves approach the shore (i.e.  $H < \lambda/2$ ) they are no longer considered to be deep water waves and, as such, they can be modified in various ways (Southgate, 1981 and 1987):

- **Shoaling.** The height of a wave varies with the depth of water in which the wave is travelling. In very shallow water this can result in an increase in wave height or shoaling. This results in increased energy and power densities in shallower waters close to shore.
- **Friction and Wave Breaking.** The increase in wave height produced by shoaling can be offset by other mechanisms. As waves become steeper they can break thereby losing both height and energy in turbulent water motion. In shallower areas the water disturbance caused by surface wave motion can extend down to the sea bed. In these cases friction between the water particles and the sea bed can result in energy loss.
- **Refraction.** As the waves propagate into shallow waters near to the coast, the wave fronts are bent so that they become more parallel to the depth contours and shoreline. Clearly this change of direction is of great importance to those shallow water wave energy devices whose capture efficiency is orientation dependent.
- **Diffraction and Reflection.** The phenomenon of the refraction of sea waves is similar to the optical refraction of light. Other effects analogous to optical behaviour occur such as diffraction (waves bending around and behind barriers) and reflection. All these types of behaviour are dependent on the detailed variation of sea bed topography and can lead to the focusing of wave energy in concentrated regions called “hot spots”.

### **Real Sea Characteristics**

The above description refers to the behaviour of simple, monochromatic waves. Real seas contain waves which are random in height, period and direction. Within a fixed length of time (corresponding to a sea state) the characteristics of real seas remain constant. Statistical parameters must be used in order to describe such sea states and to determine their characteristics which are relevant to wave energy devices.

Wave height and period can be represented by statistical measurements of wave height and energy period. The ones commonly used are the root-mean square of wave height,  $H_{\text{rms}}$ , or significant wave height,  $H_s$ , ( $\sim 4H_{\text{rms}}$ ) and the wave energy period  $T_e$ .

Sea conditions can be calculated from a knowledge of the wind climate responsible for the waves (Hasselmann *et al*, 1976; Darbyshire and Draper, 1963). One such model (Pierson and Moskowitz, 1964) was often used in the UK Wave Energy Programme (ETSU, 1985) for

programming wave makers in wave tanks tests. It describes the distribution of energy,  $S$ , as a function of wave frequency,  $f$ :

$$S\{f\} = Af^{-5}\exp(-Bf^{-4}) \quad \text{Eqn. 2.4}$$

where  $A$  is a constant and  $B$  is a function of the wind speed.

Some more refined equations (Mitsuyasu *et al*, 1964) provide descriptions of sea states which include the spread in wave direction,  $\Theta$ , and have also been used in wave tank tests (Edinburgh, 1979). The effect of this variation in wave direction is often represented as a directionality factor,  $DF$ , which is the fractional amount of power in a random sea which would be intercepted by a uni-directional wave energy device.

$$DF = \frac{\int P\{\Theta\}\cos\{\Theta\}d\Theta}{\int P\{\Theta\}d\Theta} \quad \text{Eqn 2.5}$$

where  $P\{\Theta\}$  is the average power of a wave travelling in direction  $\Theta$ .

Figure 2.2 represents a “wave rose”, which shows the angular distribution of wave power (as a percentage of the total average wave power) in deep waters off the west coast of the UK. This indicates that most waves comes from bearings between  $250^\circ$  and  $330^\circ$ . For deep waters off the west coast of the UK, typical directionality factors are 0.8 - 0.9 (Whittaker *et al*, 1992b).

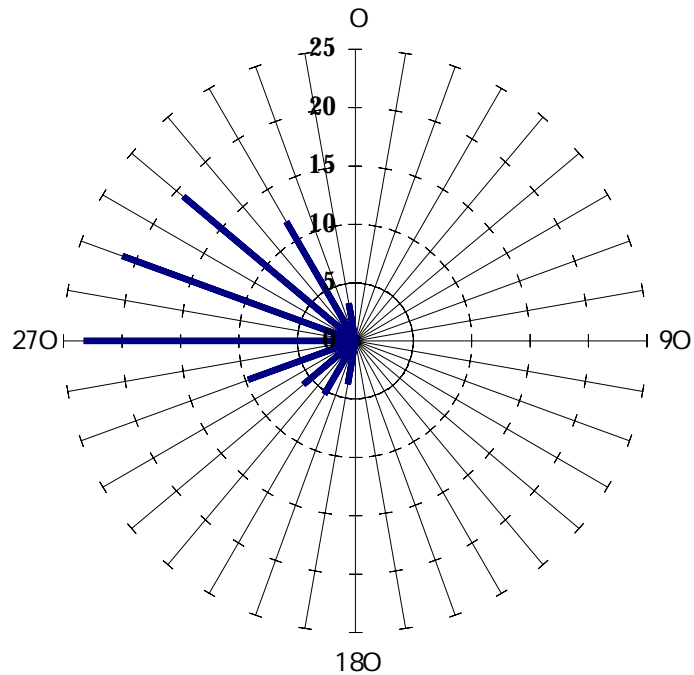
As the waves approach the shore and the shallower waters close to it, the wave modification mechanisms described above lead to a reduction in the angular distribution of wave power and a corresponding increase in directionality factor.

For isolated devices capable of either changing their orientation or capturing waves from any direction, directionality factors are of little relevance. However, for schemes using a line of devices, the directionality factor limits the amount of wave energy intercepted by the devices and hence their output.

The power within a sea state can be estimated by substituting  $H_s$  (or  $H_{rms}$ ) and  $T_e$  into equations similar to those describing the power in monochromatic seas, e.g.

$$P(\text{kW} / \text{m}) = 0.49H_s^2 T_e \quad \text{Eqn. 2.6}$$

**Figure 2.2 Wave Rose for 100 m Water Depth West of UK\***



\*Units are percentage of total average wave power level

The annual variation in sea states can be represented by a scatter diagram (e.g. Table 2.1), which indicates how often a sea state with a particular combination of  $H_s$  and  $T_c$  occurs annually. Equation 2.6 can be used to evaluate the power in each sea state.

The contribution of each sea state to the average annual power level is determined by its power level and its weighting factor,  $W$ , which can be thought of as the number of times that particular sea state occurs per year. Therefore, the average wave power level,  $P_{ave}$ , can be determined from a scatter diagram as:

$$P_{ave} = \frac{\sum P_i W_i}{\sum W_i} \tag{Eqn. 2.7}$$

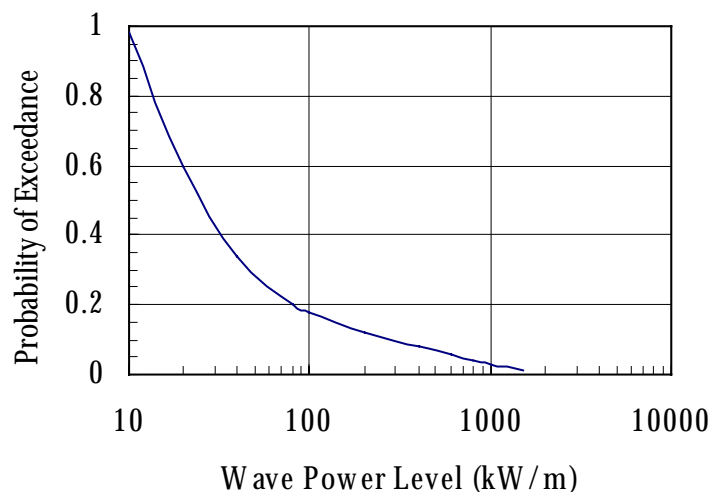
where sea states with power levels  $P_i$  occur  $W_i$  times per year.

**Table 2.1 Example of a Sea State Scatter Diagram**

Wave Height (m)	Wave Period (s)	5.5	6.5	7.5	8.5	9.5	10.5	11.5	>12
0.25		129	356	25	20	31	4	1	34
0.75		238	641	51	37	29	12	8	26
1.25		116	505	134	41	19	8	10	21
1.75		141	254	150	76	34	8	9	24
2.25		172	176	111	61	32	18	2	20
2.75		106	112	84	39	34	11	11	11
3.25		7	50	133	22	28	16	2	14
3.75			11	108	10	20	11	4	15
4.25			1	73	7	18	6	0	6
4.75				33	2	21	2	0	3
> 5				17	7	57	22	2	31

The variability in wave power levels and direction represents perhaps the most difficult challenge to designers of wave energy devices. This is illustrated in Figure 2.3, which shows the probability of exceeding a given wave power level. It can be seen that, whilst the device has to operate efficiently on average power levels of about 20 kW/m, it also has to withstand seas with power levels over 1,000 kW/m.

**Figure 2.3 Representative Distribution of Wave Power Levels**



### **UK Wave Energy Resource**

A study was undertaken of the wave climates in five key areas around the UK (Whittaker *et al*, 1992b):

- South-west peninsula of England, Isles of Scilly, South and West Wales;
- Scottish coast south of Firth of Lorne, Tiree, Coll, Islay, Jura, Mull and Colonsay;
- Scottish coast from Ardnamurchan to Glenelg and from Gairloch to Cape Wrath, Muck, Eigg, Rhum, Canna, Skye and Outer Hebrides;
- North Scottish coast from Cape Wrath to Dunnet Head and Orkney Islands;
- Shetland Islands.

This utilised the Meteorological Office's wave prediction model (Winter, 1979) at fifteen locations around the British Isles (Figure 2.4) to calculate the deep water wave climate for the period from February 1983 to July 1986.

The nearshore and shoreline wave energy resources were calculated using a combination of spectral analysis techniques and a computerised refraction and energy dissipation model developed by Hydraulics Research Ltd. (Southgate, 1981 and 1987). This required the accurate modelling of the bathymetry of the UK western seaboard with grids as fine as 150 m spacing to enable the use of a forward ray tracking model. This identified numerous hot spots along the coastline. For 78 of these sites with favourable features for a wave energy scheme, a more detailed analysis was carried out by running the ray model in reverse and by taking into account the effect of energy dissipation from sea bed friction (Bretschneider and Reid, 1954) and wave breaking (Weggel, 1972).

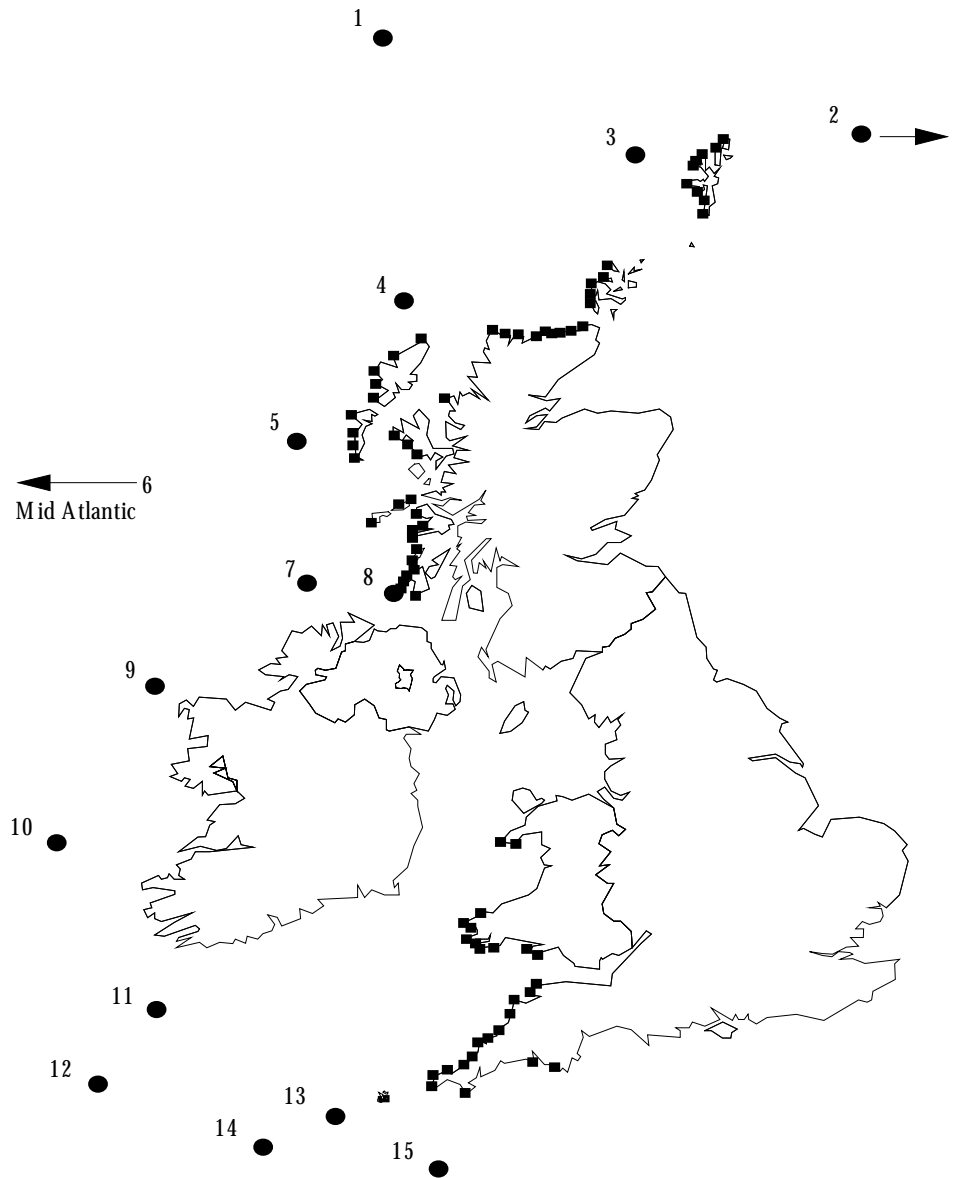
### ***Deep Water Resource***

The results for deep water were expressed as a set of representative spectra; each spectrum consisted of wave height, period, power level and annual weighting (e.g. Table 2.2). These predicted wave power levels between 66 and 76 kW/m for most of the parts of the UK's western coast that were not shielded by Ireland.

The total average wave energy resource in deep water was evaluated by integrating the wave power along the accessible parts of the UK's western coastline (i.e. leaving out areas for shipping lanes, regions for submarine practice, etc.).

The resulting deep water resource was 600 - 700 TWh/year. Exploitation of most of this resource would require significant investment in upgrading the transmission system in the north and west of Scotland. However, consideration is being given to deploying a HV transmission line from Iceland to the UK (in order to exploit Iceland's vast renewable energy sources) and from Ireland to the UK.

**Figure 2.4 Areas Studied for UK Wave Energy Resource Assessment**



Key

- 1-15 Offshore locations for application of Met Office model
- Shoreline and nearshore sites studied in detail



**Table 2.2 Representative Deep Water Spectra**

Significant Wave Height $H_s$ (m)	Energy Period $T_e$ (s)	Wave Power Level $P_i$ (kW/m)	Annual Weighting $W_i$
2.1	5.9	12.7	0.45
1.7	7.1	9.6	2.97
2.1	9.0	19.2	1.67
2.3	10.2	26.6	0.46
2.7	11.8	41.7	0.15
4.2	7.7	67.6	0.83
3.6	8.7	55.7	1.76
3.6	10.5	67.2	1.00
3.9	12.9	98.3	0.14
5.6	8.8	133.3	0.76
5.0	9.9	124.0	2.11
5.2	11.7	157.9	1.13
8.7	10.8	402.6	0.48
9.4	13.2	615.5	0.20
2.0	6.0	11.4	1.25
2.0	7.2	15.1	3.66
2.2	8.9	22.2	3.81
1.9	12.4	21.9	1.71
3.5	7.5	44.9	0.91
3.3	8.4	44.6	3.47
3.2	10.5	54.2	2.86
3.6	13.2	83.5	0.40
5.3	8.8	120	1.06
5.2	10.0	139.4	2.79
4.8	11.5	129.9	2.94
5.5	13.3	198.0	1.22
6.6	9.1	196.8	0.89
13.5	13.6	1225.8	0.25
16.3	15.7	2047.3	0.08
2.0	5.9	11.7	1.09
2.1	7.2	15.9	4.15
2.0	8.9	17.6	6.64
1.9	11.7	20.1	2.95
1.7	13.6	20.2	0.33
3.4	7.5	41.3	1.25
3.4	8.8	50.1	3.00
3.5	10.5	64.0	2.22
3.8	13.4	92.6	0.39
5.0	9.1	111.4	1.16
4.9	10.0	122.1	2.80
4.7	11.9	128.4	2.91
6.1	15.3	279.3	0.56
8.0	10.4	333.2	0.68
10.7	12.3	687.9	0.30
13.6	14.7	1336.1	0.16
21.1	17.7	3865.2	0.03
2.1	5.9	12.9	1.17
1.8	7.2	11.3	4.93
1.8	9.0	15.3	4.43
1.4	11.7	10.8	1.26
3.2	7.3	36.3	0.61
3.3	8.4	44.9	2.22
3.9	9.7	74.7	1.04
4.0	12.6	101.6	0.13
5.6	8.8	134.9	0.29
5.0	9.4	118.2	0.66
4.7	10.1	111.6	1.14
5.2	11.3	151.8	0.79
6.8	9.9	223.1	0.32
8.4	11.0	383.0	0.35
9.2	12.6	517.9	0.29
15.3	16.4	1882.5	0.06

The resulting deep water resource was 600 - 700 TWh/year. Exploitation of most of this resource would require significant investment in upgrading the transmission system in the north and west of Scotland. However, consideration is being given to deploying a HV transmission line from Iceland to the UK (in order to exploit Iceland's vast renewable energy sources) and from Ireland to the UK. These are likely to be longer term projects (>2010) but, if they do take place, they would enable not only a large part of this resource to be exploited but they would also allow the much greater resource of the Northern Atlantic to be tapped (Salter, 1996).

### ***Nearshore Resource***

A similar exercise for the nearshore resource (i.e. at 20 m water depth). These results showed more variation (e.g. 25-35 kW/m for the western seaboard of Cornwall and 30-40 kW/m for the Shetland Isles). When summed in a similar manner to the deep water resource, the UK nearshore resource was estimated to be 100 - 140 TWh/year.

### ***Shoreline Resource***

The shoreline resource is very site specific, with some areas being unsuitable for wave energy devices (e.g. shorelines of historic, scientific, ecological or visual importance). In addition, the resource varies considerably from point to point (Figure 2.5), as explained above. Therefore, any estimate is subject to considerable uncertainty. Taking these factors into account, the estimated UK shoreline resource is ~ 2 TWh/year.

### **Overview of the UK Resource**

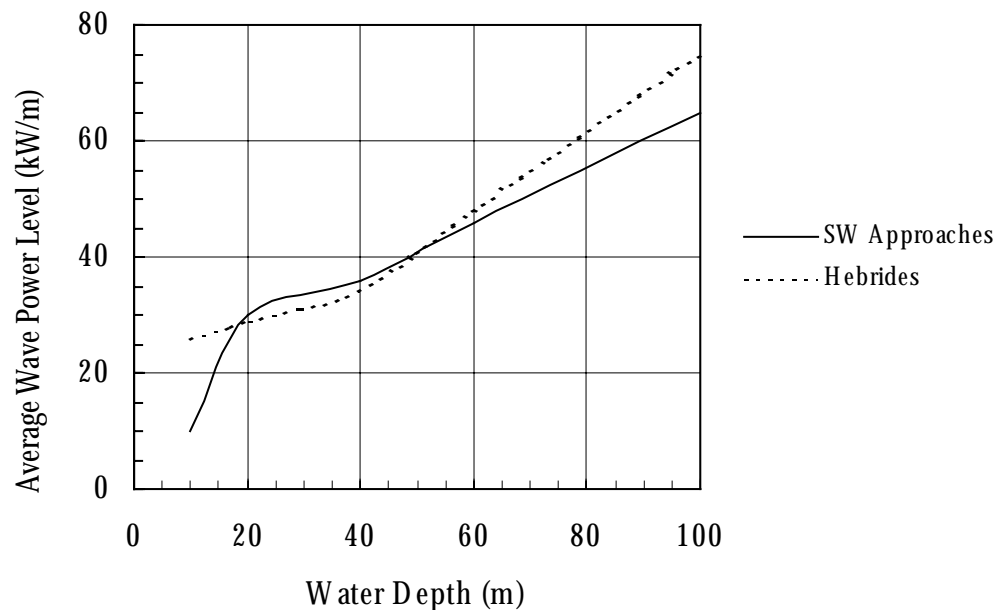
The resource values given above are different to those from the earlier review (Thorpe, 1992). This is attributable to:

- More accurate modelling of the resource distribution over a number of years in order to take account of year-on-year variability;
- Incorporating other limitations on the deployment (e.g. environmental impacts, need for transmission systems);
- Ignoring the wave resource on the eastern and southern coasts, where the wave power levels are too low for commercial exploitation.

However, further work is required to confirm the wave power levels and directionality factors used in this review.

### **Overview of the Global Wave Energy Resource**

Oceans cover three-quarters of the earth's surface and represent a large natural energy resource, estimated by the World Energy Council (1993) as ~ 2 TW. The IEA (1994) has indicated that wave energy may eventually provide over 10% of the world's electricity supply.

**Figure 2.5 Variation of Wave Power Level with Water Depth and Location**

A preliminary evaluation of world wave power levels carried out as part of this review confirms a global resource of more than 1 TW. Using the latest designs of wave energy devices, this resource could produce over 2,000 TWh of electricity annually.

### 2.2.2 Capital Costs

A spreadsheet-based capital costing model has been developed (Thorpe, 1993a and 1993b). It is based on work originally carried out by Atkins Oil and Gas (1992) and builds on the experience gained in both the 1992 Review (Thorpe, 1992) and subsequent work for industry. It employs a modular approach which is used to define four major cost centres for any wave power scheme:

- Device structure
- Mechanical and electrical plant
- Electrical transmission
- Transportation and installation.

The scheme is described by three sets of parameters:

- **Project Parameters.** These define the type, scale, location and time scale of the project (e.g. device type, total output etc.)
- **Independent Parameters.** These describe the location of the construction yard, area for deployment and point of connection to the National Grid, as well as the water depth and sea bed condition at the device site.
- **Dependent Parameters.** These can be deduced from the foregoing parameters by algorithms or defaults. One example of an algorithm is how the device type, total output

and project duration would define the total number of devices, the number to be built each year, and hence the size of the construction facility. Typical defaults would be the type of M&E plant or the amount of concrete used in construction for each device type.

Costs are calculated by assigning default values to various parameters or algorithms derived therefrom. However, a "What if" facility was incorporated in the spreadsheet, which permits the user to override the defaults used. This allows the model to accommodate additional information, design development and new device types. The cells containing the default values for the spreadsheet were locked (i.e. they could not be changed). Therefore any modification to the spreadsheet had to be through the separate "What if" facility, which highlighted any such changes.

### 2.2.3 Availability

In the context of this assessment, system availability has been defined as the probability of the whole system functioning at any specific time and is therefore taken to include the effects of scheduled maintenance and breakdowns (i.e. both unforced and forced outages). In simple systems requiring no maintenance, the fractional availability, A, can be calculated as:

$$A = \frac{MTBF}{MTBF + MTTR} \quad \text{Eqn. 2.8}$$

where MTBF is the mean time between failures and MTTR is the mean time to repair a failure.

A simple availability model was developed for the previous UK Review of Wave Energy (Thorpe, 1992), which used failure rate and repair time data from a wide range of sources to predict the availability (A in Equation 2.8). This has been updated in work carried out since that time (e.g. Thorpe, 1993a). The model also predicted the repair loading, which is the number of hours repair activity required for each hour of the scheme's operation. For instance a repair loading of 10 hours/hour implied that 10 repair crews were required to work full-time (24 hours per day) or 30 repair crews were required to work normal eight hour shifts. Two types of repair loading were calculated.

- **Active Repair Time.** This covered the time actually spent at the various fault sites carrying out the repairs.
- **Active Plus Transit Repair Time.** This covered not only the active repair time outlined above but also the time spent reaching the fault location. For failures in offshore items, this included both the time required for a repair ship to reach the fault location and any delays which could arise from waiting for a suitable weather window.

### 2.2.4 Operation and Maintenance Costs

Good maintenance procedures are essential if any energy technology is to perform successfully. However, in addition to this planned maintenance there will be other, unscheduled outages due to component failure. Therefore, any estimation of annual O&M costs has to encompass both these aspects. This assessment evaluates three main components of O&M costs.

- **Cost of Spares.** These are the costs associated with providing spares to replace faulty equipment. In order to ensure that the wave power scheme has an adequate supply of replacement parts, it has been assumed that M&E spares sufficient for one year would be held. A simple estimate of the one-off cost associated with complete replacement of equipment failing during one year's operation was obtained from multiplying failure rates by replacement costs. The annual number of failures of each major M&E and transmission subsystem was derived from the MTBF calculated in the availability assessment. The capital cost associated with each subsystem was calculated using the parametric capital cost model.
- **Repair Costs.** In practice the faulty equipment replaced by the spares in the paragraph above would be repaired and used as spares in the future. This would entail an additional repair cost which would be some fraction of the above figure. For the purposes of the review, this fractional replacement cost factor for M&E plant was taken to be 10% of the capital costs obtained from the parametric capital cost model.
- **Operational Costs.** These are the costs associated with providing maintenance crews and vessels to enable repairs to be carried out. The availability assessment provided an estimation of the number and types of repair crews required to provide the level of availability for each device as calculated in Section. The parametric capital cost model provided data on manpower costs, vessel hire rates etc.

### 2.2.5 Electrical Output

The average annual output has been determined in four main steps as shown in Figure 2.1.

- **Available Wave Power.** The amount of wave energy available for capture has a strong influence on the amount of energy any device can generate. It is a function of location, water depth and local sea bed topography. This aspect was studied in the project undertaken by the Queen's University of Belfast, as described in Section 2.2.1.
- **Captured Wave Power.** The efficiency with which a particular device captures wave power is a function of the sea state. Most devices have been tested in wave tanks to determine this aspect of their performance. In those cases where no such data are available, theoretical analysis had to be used. The applicability of such data to the performance of full size devices in real seas is one of the most important areas of uncertainty in this review.
- **Maximum Annual Output.** The amount of energy delivered to the grid from a particular device in a given sea state depends on the losses in the power chain (turbines, generators, rectifiers, transformers, transmission lines etc.). Data exist on the relative losses as a function of power level and rating of electrical equipment but often the performance of mechanical plant had to be estimated from theoretical assessments.
- **Actual Annual Output.** The amount of energy predicted by the above calculations assumes that the wave energy scheme functions continuously (i.e. without failure). In practice there will be periods of reduced output due to breakdown and maintenance and an availability model was developed to model these and their effect on electrical output (see Section 2.2.3).

### 2.2.6 Determination of Annual Costs

There are three main factors which make up the annual running cost of any power station: fuel, repayment of capital costs and payment of recurrent costs such as insurance and O&M.

The annual sum involved in repayment of the capital cost of a wave power scheme can be assessed in a number of ways. The approach adopted in this review was that used in previous appraisals, namely amortisation of the capital costs over the complete lifetime of the scheme using various discount rates. Therefore if a scheme can be built in one year for a capital cost of C, then the annual sum repaid (Ann) at a discount rate (r) is given by:

$$\text{Ann} = \frac{Cr}{[1 - (1 + r)^{-n}]} \quad \text{Eqn. 2.9}$$

where n is the lifetime of the project (in years). Therefore, for such a simple scheme, the cost of electricity (E) is given by:

$$E = \frac{\text{Ann} + \text{Insurance} + \text{O \& M C osts}}{\text{Annual O utput}} \quad \text{Eqn. 2.10}$$

In addition to the predicted cost of electricity, this review contains another economic measure, the internal rate of return for a project (IRR), which is the interest rate received for an investment consisting of payments (negative values) and income (positive values) that occur at regular periods. This is calculated against income from a range of prices for which the electricity generated by a wave power plant is sold.



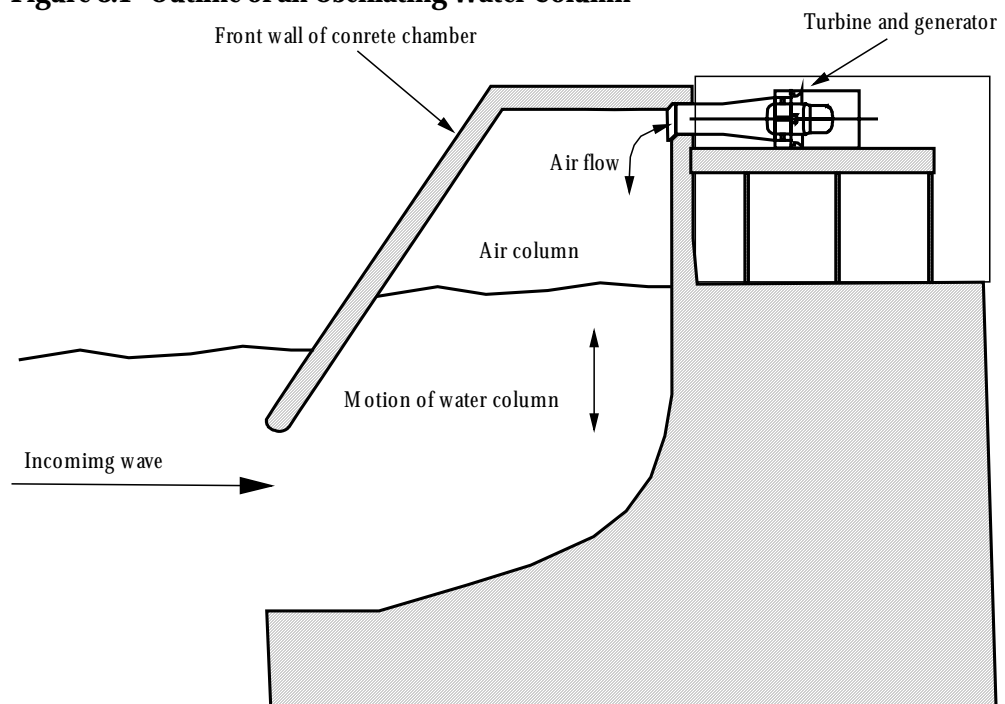
## 3 Shoreline Wave Energy - the Limpet

### 3.1 INTRODUCTION

The Limpet is a shoreline-based oscillating water column (OWC), which has been developed by Queen's University of Belfast and Wavegen of Inverness. It builds on the experience gained in the UK's only wave power device, the OWC on Islay. Wavegen are currently building a Limpet on the same island.

An OWC consists of a partially submerged, hollow structure, which is open to the sea below the water line (Figure 3.1). This structure encloses a column of air on top of a column of water. As waves impinge upon the device, they cause the water column to rise and fall, which alternatively compresses and depressurises the air column. If this trapped air is allowed to flow to and from the atmosphere via a turbine, energy can be extracted from the system and used to generate electricity. Energy is usually extracted from the reversing air flow by Wells' turbines, which have the property of rotating in the same direction regardless of the direction to the airflow.

**Figure 3.1 Outline of an Oscillating Water Column**



### 3.2 DESCRIPTION OF THE LIMPET

The design of the Limpet is still being refined, so only a snapshot of the Limpet at this stage in development can be given. It should also be noted that, since the device is now at the



demonstration stage, there is some commercial sensitivity around certain aspects of the scheme. Wavegen have provided significant information but requested that commercially sensitive data should not be reported. This explains the layout of certain text and figures in this Chapter.

### 3.2.1 The Structure

The Limpet is a modular OWC, developed from operational experience gained on the Islay device (Whittaker and Raghunathan, 1993; Whittaker *et al*, 1995a and 1995b). It follows the designer gully concept, in which the device is constructed and fixed in place close to the shoreline, being protected from the sea by a rock bund (Figure 3.2). When the device is completely installed, the bund is removed, allowing the sea access to the device.

The device consists of three water columns placed side by side in a man-made recess, which forms a slipway at an angle to the horizontal (Figure 3.3). In the current design for the island of Islay, the water column boxes are made from a steel-concrete-steel sandwich called BISTEEL, giving a device width of ~21 m. Other, novel construction methods are currently being evaluated. The device is anchored to the rock promontories on either side and to the base.

Wave tank tests have shown that the inclined slope increases the capture efficiency, whilst the dog leg on the front wall inhibits outflow and so helps to prevent exposure of the lower lip to air.

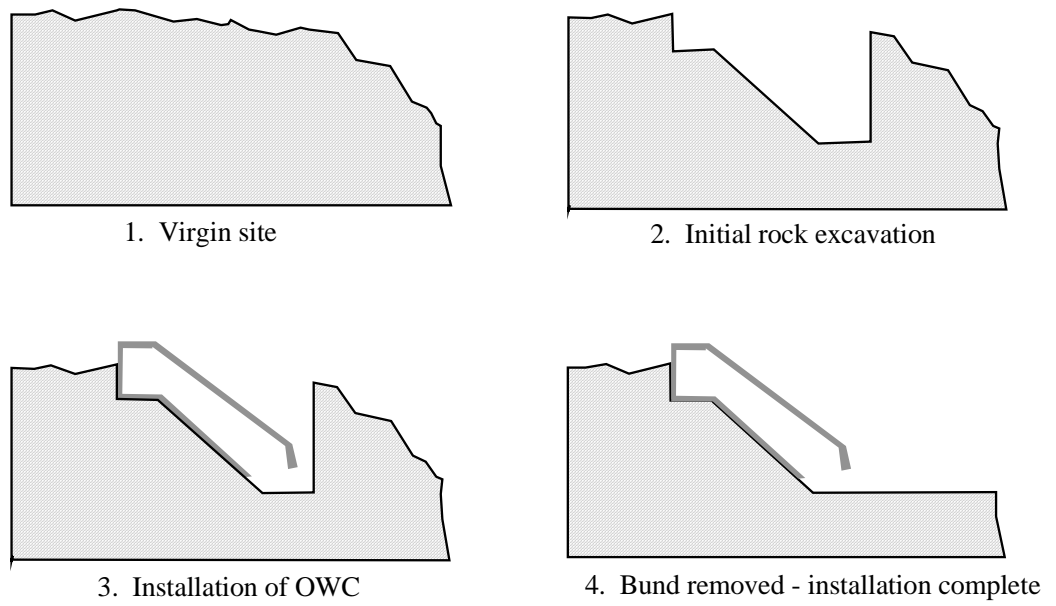
Some aspects of the plant characteristics are discussed in more detail in the next Chapter, where similar plant is proposed for the OSPREY.

### The Turbines

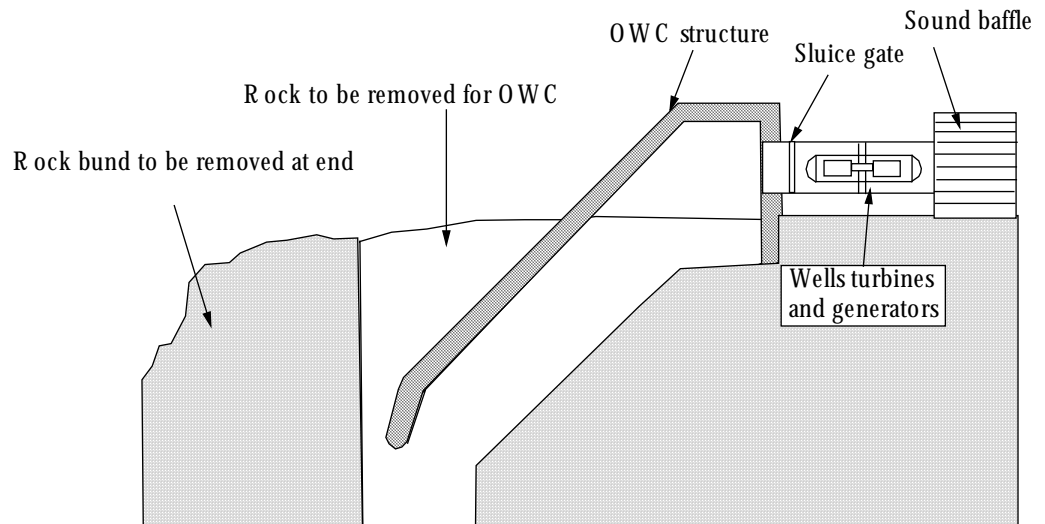
There are two low solidity, counter rotating Wells' turbines, each rated at 500 kW. The initial blade design and material have yet to be confirmed but it is likely that they will be solid blades (for robustness) with air flow stabilisers (to maintain streamlined flow to higher angles of attack).

The turbines are placed behind the OWC chambers and the associated electrical equipment is located behind the turbines, where it is protected from sea water splashes by a rock bund. Each set of turbines is protected by a sluice gate, which can prevent the turbines being subjected to green water in stormy seas. The turbines also have flywheels to smooth out energy supply, as well as blow out valves. (See also Chapter 4 for other information about the turbines).

**Figure 3.2 Designer Gully Concept**



**Figure 3.3 Outline Side View of the Limpet**



## The Mechanical and Electrical Plant

Several different options are being pursued for the M&E plant, including power control electronics (as before) as well as hydraulic or pneumatic energy storage.

### 3.3 ASSESSMENT OF THE LIMPET

The device design is not finalised and there are several different options under consideration for most aspects of the scheme. It is important to recognise that the first scheme is intended to evaluate a range of options, including material selection and installation techniques. The aim is to identify cost reduction methods and to ensure replicability and reliability for future, commercial devices. Therefore, any comments must take into account this state of flux.

#### 3.3.1 Technical Considerations

Most aspects of the system have been developed in the course of over a decade's work in this area as well as co-operation with other teams and industry. Therefore, there is only a limited number of areas of uncertainty; most of these can be addressed only by a demonstration device:

- The emplacement technique is a novel one but appears to be feasible. The removal of any rock debris is essential in order to prevent the debris entering the OWC chamber in service.
- The capture efficiency of the system has been proven in model testing but it is likely to be site-specific; the selected site has a shoreline profile that effectively provides the device with harbour walls, which increase capture efficiency (Hunter, 1991);
- The turbines are situated close to the OWC end of the air vents (~ twice the turbine diameter), which could result in non streamlined air flow and consequential loss of efficiency (Curran, Raghunathan and Whittaker, 1995). However, Wavegen have studied this both theoretically and experimentally and consider it to have only a very small effect.
- The device has a design life of +30 years for the structure but that of the mechanical and electrical plant will be somewhat less. The approach has been to use robust and reliable components, so they should achieve the adequate reliability found when used in other, similar situations.

#### 3.3.2 Replication Potential

The unit size will be ~ 1 MW allowing the system to integrate with nearly all parts of the grid. Wavegen have produced a modular system, tailored for deployment on islands and in remote locations. Therefore, the only limits on its replicability will be economic (which is discussed later), geographic and environmental:

- **Geographic:** the scheme needs the right combination of shoreline topography and geography, together with low tidal ranges and closeness to the grid;
- **Environmental:** the original Islay scheme impinged on the shoreline and had a some visual impact. Wavegen have tried to address this in developing a low profile, composite roof, modular system with a much reduced visual impact. They have also considered decommissioning of the device after service and have set aside monies to account for this.

Identification of the most suitable sites would require a detailed assessment of the above factors. The appropriate geographic factors have been identified for a minimum of 72 sites around the UK (Whittaker *et al*, 1992b). A number of sites around Ireland have also been identified but this information is not yet available (Falcão, Whittaker and Lewis, 1993). A very approximate and conservative estimate of the replication potential is for several hundred devices in the UK. QUB identifies a “modest target” of 1 GW (corresponding to 1,000 devices) in the EC.

### **3.4 ECONOMIC ASSESSMENT OF THE LIMPET**

#### **3.4.1 Capital Cost**

This is site-specific and subject to change following ongoing developments. There was a large degree of uncertainty in estimating these costs, because of the lack of detailed information, leading to predictions in the range £ 850,000 to £ 1,160,000 (the breakdown of costs is shown in Figure 3.4).

#### **3.4.2 Operational and Maintenance Costs**

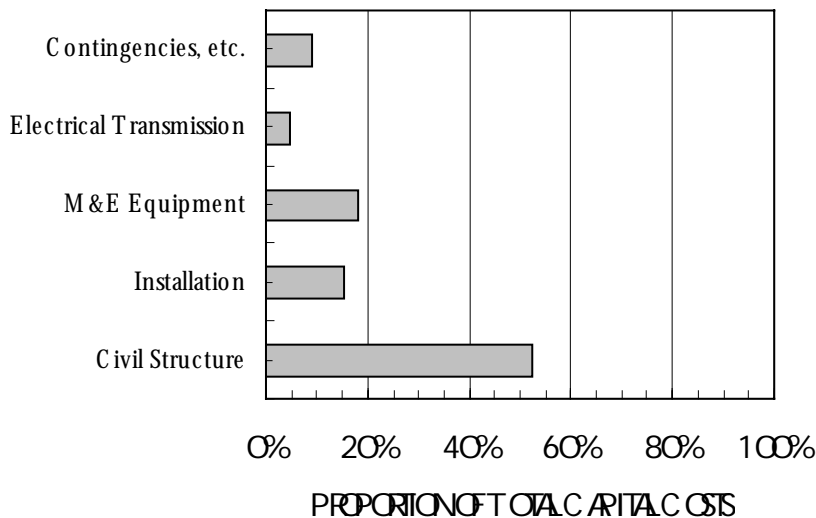
The annual operation and maintenance costs were estimated to be approximately £ 23,000. The system is being developed with a view to it being maintained in remote locations by indigenous staff.

#### **3.4.3 Electrical Output**

The average wave power level at the Islay site is 20 kW/m (Falcão, Whittaker and Lewis, 1993). At this location, the device is estimated to have an average electrical output of 206 kW, amounting to 1,800 MWh/year (Whittaker, 1997).

Details concerning certain aspects of the electrical output are commercially sensitive (e.g. capture efficiency of this sloped OWC chamber). In addition, the energy output from this particular scheme is enhanced by the shape of the cliff which forms sloping harbour walls either side of the OWC chamber, thereby increasing the effective capture width of the device. However, using the experience gained on other devices, a model of the whole system was developed as part of this review, which could optimise the number of Wells’ turbines operating in each sea state. This indicated an annual output of 1,800 MWh, which is close to the output predicted by the designer.

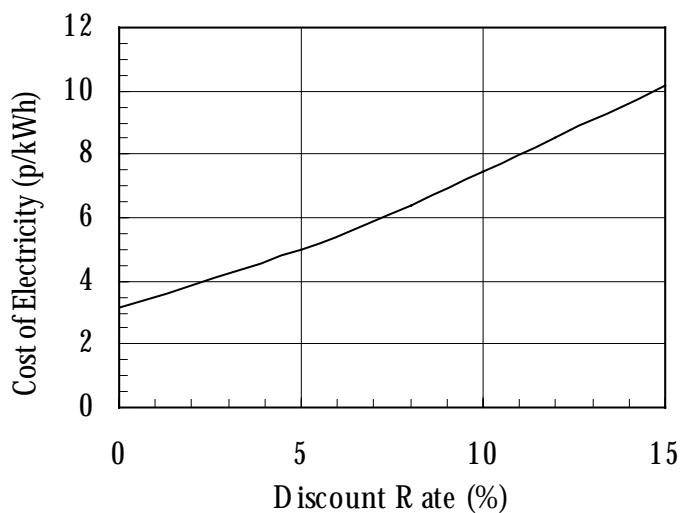
**Figure 3.4 Breakdown of Capital Costs for the Limpet**



**3.4.4 Generating Costs**

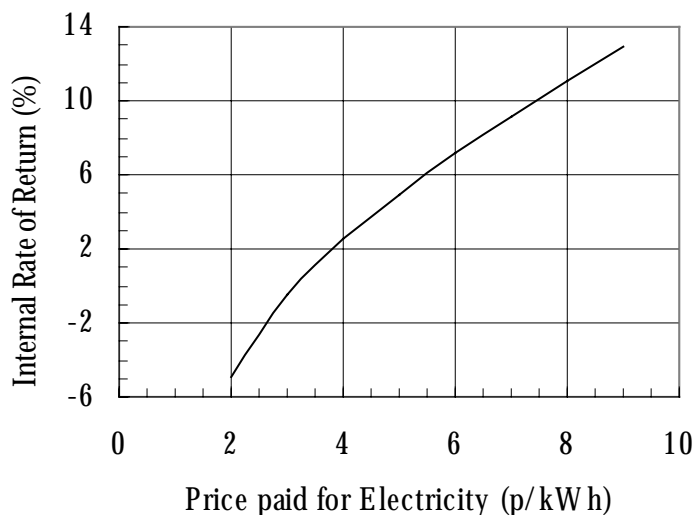
Using the above information, the generating costs for a Limpet device were evaluated for a lifetime of 30 years using different discount rates. The results are shown in Figure 3.5. Again, it should be emphasised that this is for the current design of device and takes no account of possible improvements.

**Figure 3.5 Effect of Discount Rate on Electricity Costs for the Limpet at Islay**



**3.4.5 Internal Rate of Return**

The internal rate of return was calculated for a range of electricity prices paid to the generator. The results are shown in Figure 3.6 and indicate a positive return on investment for electricity prices above ~ 3 p/kWh.

**Figure 3.6 Effect of Electricity Prices on IRR for the Limpet at Islay**

### 3.5 RESOURCE-COST CURVES

The cost-resource curve will be determined by the average wave power levels at the opening to the LIMPET (*inter alia*). This can be modified in two main ways:

- Change of site. For instance some sites can have shoreline wave power levels of nearly 50 kW/m (arising from “hot spots” - see Section 2.2.1);
- Increase the effect of the harbour walls. Work in this area suggests that the captured power could be increased by 60 % by the addition of angled walls (Whittaker and Stewart, 1993).

Simply increasing the capture factor does not necessarily bring about a proportional decrease in electricity costs, because higher wave power levels might require changes to the ratings of the components (and hence their costs). The factors of safety built into the civil structure should be sufficient to accommodate all shoreline wave climates, so there should be little variation in the cost of the civil structure (other than influences of the shoreline topography, geology, etc.).

A simplified approach has been adopted in order to give some indication of the potential effect of different wave power levels. In this, it has been assumed that the structure remains the same and that changes in the power levels effect only the costs and efficiencies of the power chain (i.e. turbines, generators, etc.). This was modelled for different power levels, again trying to optimise the scheme. Table 3.1 contains the results for a higher wave power level (32 kW/m), which is more representative of the most promising UK locations (Figure 2.4).

**Table 3.1 Characteristics of the Limpet OWC**

Wave power level	32 kW/m
Annual output	2,300 MWh
Capital cost	1,400 £k
Annual operating cost	29 £k

The resulting relationship between wave power level and generating cost was used to predict the cost of electricity from 26 of the most energetic shoreline sites around the UK (Whittaker *et al*, 1992b). It was assumed that a maximum of 10 devices could be positioned at each location. The resulting resource-cost curves at 8% and 15% discount rate are shown in Figure 3.7 (there is no contribution at less than 10 p/kWh at 15% discount rate). Again, it should be noted that these do not take into account any of the potential improvements identified by Wavegen.

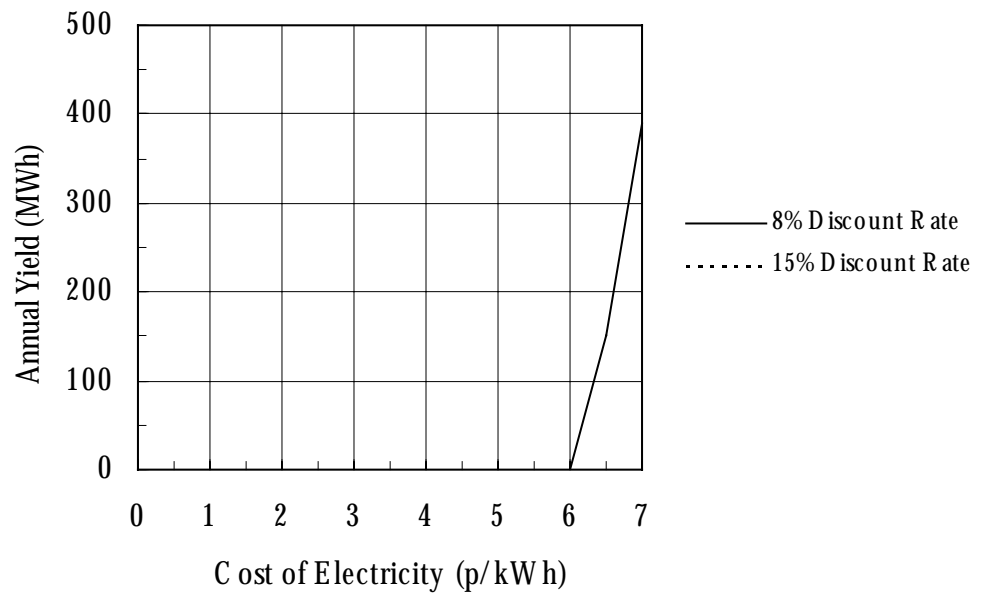
### 3.6 SCOPE FOR IMPROVEMENT

Given that the device has not yet been built, it is somewhat presumptuous to suggest improvements. Nevertheless, there are several aspects which might be developed further:

- The capital cost could be offset if the OWC chamber can be built as part of another structure (e.g. a breakwater).
- The size of turbines and OWC chamber can be tailored for a particular wave climate.
- The turbine efficiency could be improved if variable pitch blades were used. The design team are considering this.
- The capture efficiency of the OWC system could be improved by phase control or “latching”, which is delaying the movement of the water column so that its velocity comes into correct phase with the applied hydrodynamic force (Nichols *et al*, 1991). Such a system is being developed as part of the JOULE Programme (Salter and Taylor, 1995).

At the moment, it is impossible to quantify the benefits of these improvements accurately. However, they could be substantial.

**Figure 3.7 UK Cost-Resource Curves for the Limpet**







# 4 Nearshore Wave Energy - the OSPREY

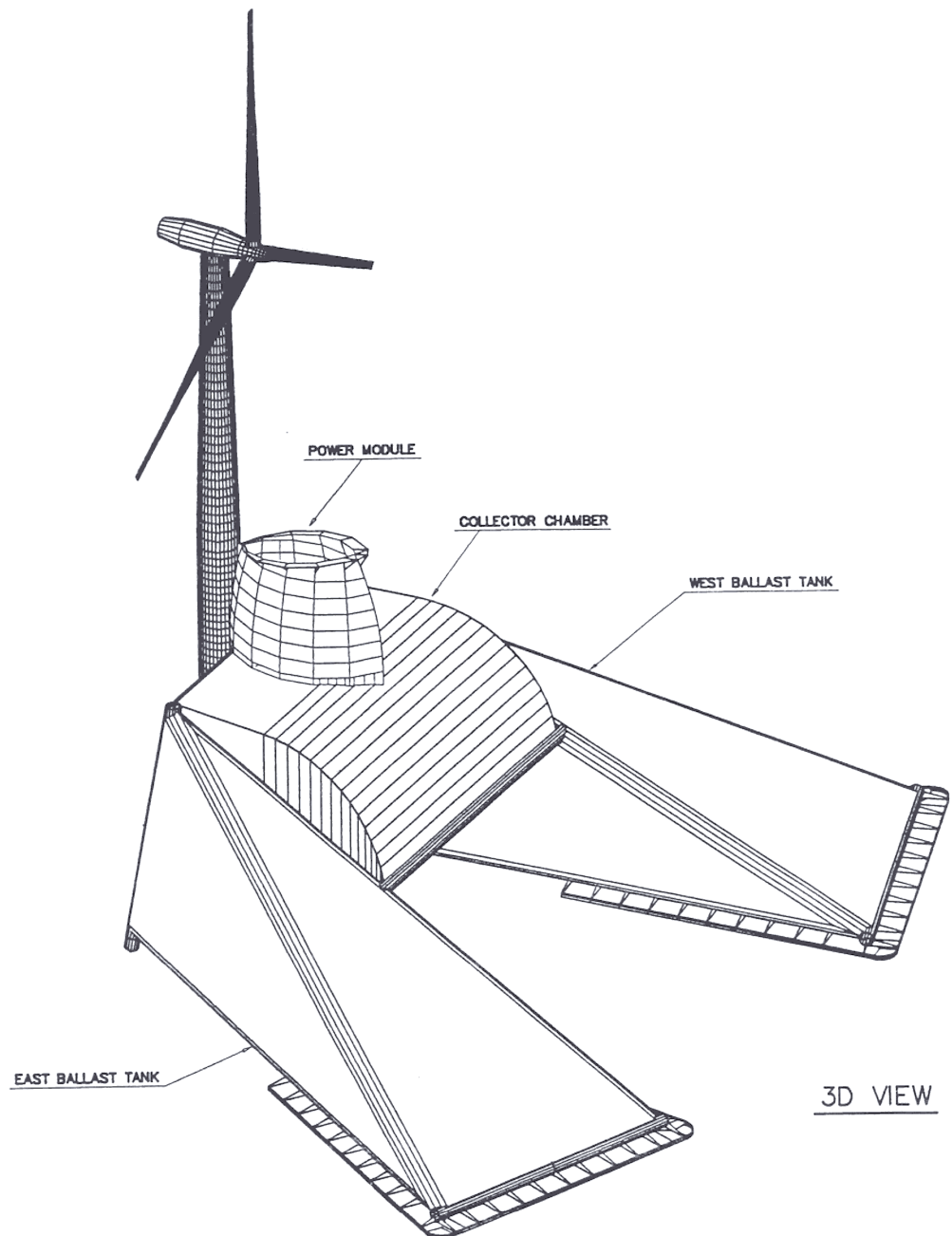
## 4.1 A BRIEF HISTORY OF THE DEVICE

Wavegen of Inverness has produced several designs for an oscillating water column device (OWC) called the OSPREY (Ocean Swell Powered Renewable Energy), which incorporates a wind turbine. The original work was carried out by Applied Research and Technology (ART - now Wavegen) in conjunction with Scottish Hydro-Electric plc and the Queen's University of Belfast, with the backing of several other organisations (AEA Technology, British Steel, CEGELEC Projects, European Union - JOULE, GEC Alstom, Highlands & Islands Enterprise, Inverness & Nairn Enterprise). A prototype of the device (OSPREY1) was launched, towed and installed near Dounreay in Scotland. However, the device underwent structural failure before it could be securely installed but the experience has enabled Wavegen to learn a great deal about the practicalities of manufacturing and the difficulties in installing large devices in the sea.

A new design has been developed (OSPREY2) in which much of the structure has been replaced by concrete. This review will assess the technical prospects for both the concrete and the steel designs, before going on to assess the economic prospects of the concrete design when deployed as a small scheme consisting of 10 OSPREYs. The concrete design is chosen, because it offers the greatest scope for future cost reduction by use of alternative construction techniques.

## 4.2 THE STEEL OSPREY

The steel design is shown in Figure 4.1. It comprises a 20 m wide rectangular collector chamber in the centre, with hollow steel ballast tanks fixed to either side. These tanks face into the principal wave direction and focus the waves towards the opening in the collector chamber. The air flow from this chamber passes through two vertical stacks mounted on the chamber. Each of these contains two, contra-rotating Wells' turbines, each of which is attached to a 500 kW generator. A control module is also mounted on top of the collector chamber, containing the power control equipment, transmission system, crew quarters, etc. Behind the collector chamber and power module is a conning tower on which can be mounted a "marinised" wind turbine (currently rated at 1.5 MW). The whole device is designed for installation in a water depth of approximately 14 m and weighs (unballasted) approximately 750 t. The design life is about 25 years.

**Figure 4.1 The Steel OSPREY Design**

Source: Wavegen.

This design was assessed in an earlier report (Thorpe, 1995), which identified several areas of concern in both the structure, M&E plant and installation, as well as many positive advances in wave energy technology.

The practical experience gained on OSPREY1 has enabled Wavegen to address nearly all these concerns in developing OSPREY2. This type of experience is important to the future development of wave energy

## 4.3 THE CONCRETE OSPREY

### 4.3.1 Outline Description

The concrete OSPREY is also for a single chamber OWC, with an optional wind turbine. However, this differs significantly from the steel design not only in choice of material but also in the design of the ballast tanks, which are built into the walls surrounding the OWC chamber (Figure 4.2).

#### **The Structure**

The device is a monolithic concrete structure with a design life of >60 years. It is intended for installation in ~15 m water depth close to shore.

An independent structural assessment has been undertaken by a major civil engineering company, with extensive experience in offshore structures. The report concludes that “..... the project can proceed with some confidence in design fundamentals and materials quantities and that any outstanding design matters are limited to details which can be addressed during the final design phase”.

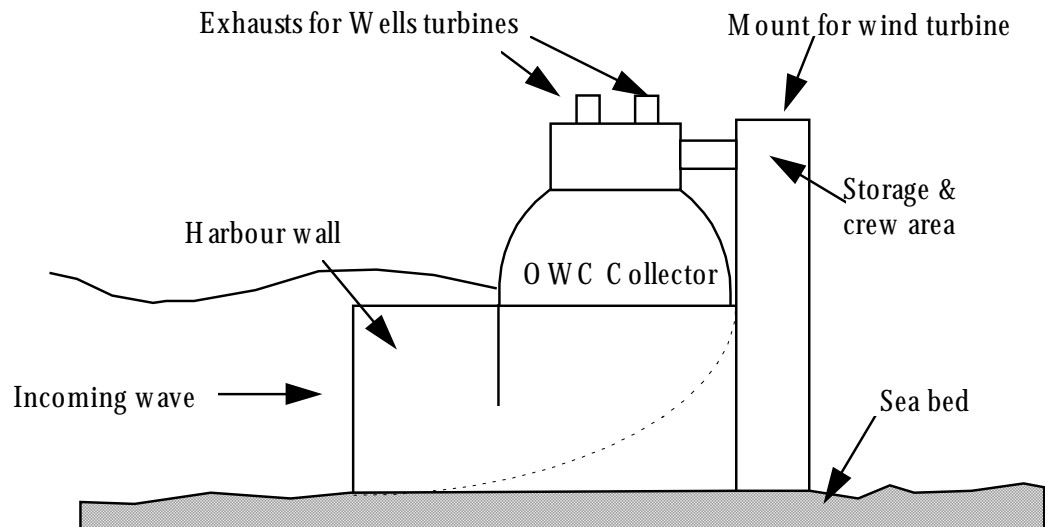
#### **The Power Chain**

The operating principles of an OWC are explained in Section 3.1. In the OSPREY2, air flow from the chamber passes through a pair of vertical stacks containing the main M&E plant. Many aspects of the design were assessed in an earlier report (Thorpe, 1995) and consideration has been given to the areas of concern identified for OSPREY1 in that report.

#### ***The Power Stack***

The requirement for corrosion resistant stacks has led to the adoption of GRP rather than steel (or the more expensive stainless steel) for the lining of the stack and reinforced concrete for the walls of the stack. Considerable work has also been carried out on reducing the noise emitted through the stack.

The possibility of green water entering the stack and damaging the turbines could be avoided by the inclusion of a strong sliding valve (sluice gate) on the OWC side of the stack, so that the entire M&E plant in the stack can be cut off from the OWC for repair and maintenance. This has been adopted in the European pilot plant on Pico and is under consideration for the OSPREY2.

**Figure 4.2 The Concrete OSPREY**

The possibility of interaction between the exhaust air and the blades of the wind turbine (leading to additional fatigue loadings on the turbine) has been reduced by adopting vertical stacks.

### ***The Wells' Turbines***

Each stack contains a pair of contra-rotating, low solidity, single plane Wells' turbines (i.e. a total of four turbines), each rated at 500 kW. The use of contra-rotating turbines minimises energy losses from swirling air after passage through the turbines. Wavegen have been at the forefront of Wells' turbine development and have manufactured the fixed pitch turbine for the Pico plant. Nevertheless, the design of the turbine for OSPREY2 is still not finalised and there are several options, each with its own pros and cons:

- There are several choices for blade material. At the moment, this is a typical offshore steel (BS 4360 Grade 50D), with a 150  $\mu\text{m}$  thick sprayed aluminium coating. However, aluminium alloy and titanium are also under consideration together as well as a variety of coatings, with implications for cost, durability and turbine inertia.
- Smoothing of the output from the turbine could be effected by inclusion of flywheels, variable vane valves or pressure release valves.
- The blades in existing Wells' turbines use a smooth profile. However, Wavegen have studied the performance of blades both experimentally and theoretically (using CFD software on supercomputers). This has led to the suggestion that the blade surface should contain flow stabilisers (similar to those found on some aeroplane wings). These help to keep the boundary layer attached to the blade (without increasing drag), thereby permitting higher angles of attack before stalling occurs.

- Current designs of turbine utilise conventional oil lubrication of the rotating shaft, with implications for maintenance of the lubrication system. It is likely that the OSPREY2 will use a programmable, grease-based system.

### ***Power Generation and Control***

Each turbine powers a 500 kW fin-cooled, cage induction generator (total electrical rating for four turbines of 2 MW), designed by GEC-Alsthom for wave energy applications. In order to control the output of the device to meet the stringent requirements on the quality of electricity produced by independent generators, a rectification/inversion system has been developed by CEGELEC (1994) to maximise conversion efficiency. These components are either standard (e.g. the fin-cooled motors have been used for deck winches on ships), or have been developed specifically for this application over several years.

The electricity can be brought ashore via an overhead cable, which will also carry the fibre optic link for control of the device from the shore.

### **Transportation, Installation and Mooring**

Following the loss of OSPREY1, considerable attention has focused on these aspects of the scheme for OSPREY2. An independent report by a major civil engineering contractor with considerable offshore experience has assessed the following operations, with favourable conclusions.

- Tow-out should produce no problems, except if the structure is damaged, leading to flooding; this has been rectified by using discrete cells in the structure.
- Tow-out with a wind turbine *in situ* could impose unacceptable loads on the turbine support structure. This could be rectified by additional temporary strengthening and support for the wind turbine tower.
- Installation would require a rock surface with a grouted interface to provide a good factor of safety; however, alternatives are being investigated.
- The procedure for lowering the device into position remains to be worked out in detail, the requirement being to avoid excessive impact loads despite the ever-present swell.

#### **4.3.2 Summary of the Technical Evaluation**

Wavegen have used the experience gained on OSPREY1 to improve many areas of their design. However, there are several aspects of the scheme which give rise to some uncertainty over the technical performance. These have been recognised by Wavegen and are being addressed. To a large extent, these have arisen out of the challenge of overcoming the drawbacks and limitations of conventional designs of OWCs (high structural costs, moderate capture efficiencies, etc.). Therefore, it is to be expected that not all aspects of the scheme have yet been finalised.

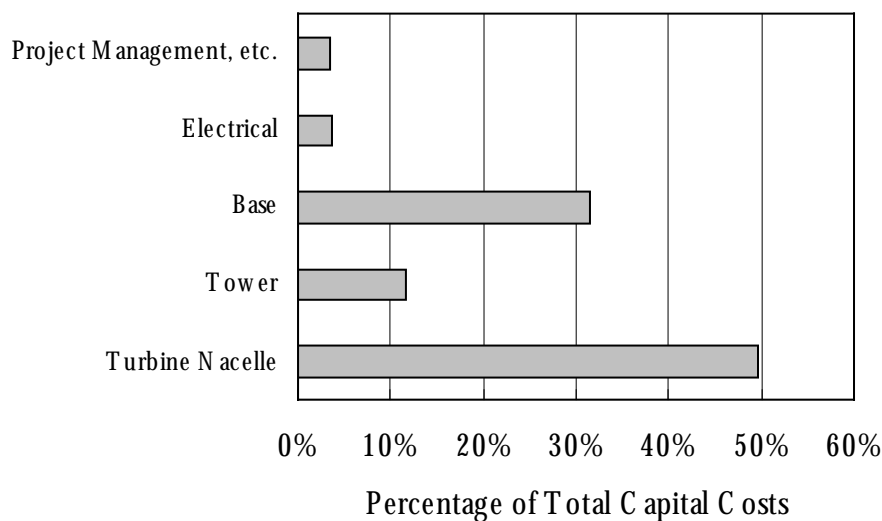
Wavegen are working in close co-operation with consulting engineers, offshore engineering companies, certification authorities, etc. Therefore, before OSPREY2 goes ahead, great confidence should have been gained in all aspects of the scheme.

#### 4.4 THE WIND TURBINE

The wind turbine used in this scheme will be rated at 1.5 MW, although larger turbines could be used in future. This type of turbine is being developed by a number of turbine manufacturers for use in offshore wind schemes. The operating conditions of a turbine on the OSPREY will be very similar to those in an offshore wind power scheme. Therefore, there should be no additional problems in its use on the OSPREY beyond those currently being addressed by wind turbine manufacturers.

The capital cost of a £ 1.5M, stand alone turbine can be broken down into its main components, as shown in Figure 4.3 (Legerton, 1997). This shows that, by using the OSPREY2 as a base, approximately 31% of the capital costs can be avoided. In addition, nearly 50% of the electrical costs can be saved by using the electrical transmission lines for the OSPREY2. Therefore, the predicted marginal cost of installing a wind turbine on an OSPREY2 is just over £ 1M, which is slightly more than that estimated by Wavegen (£ 900,000)

**Figure 4.3 Breakdown of Capital Costs of an Offshore Wind Turbine**



#### 4.5 ECONOMIC ASSESSMENT OF THE OSPREY OWC

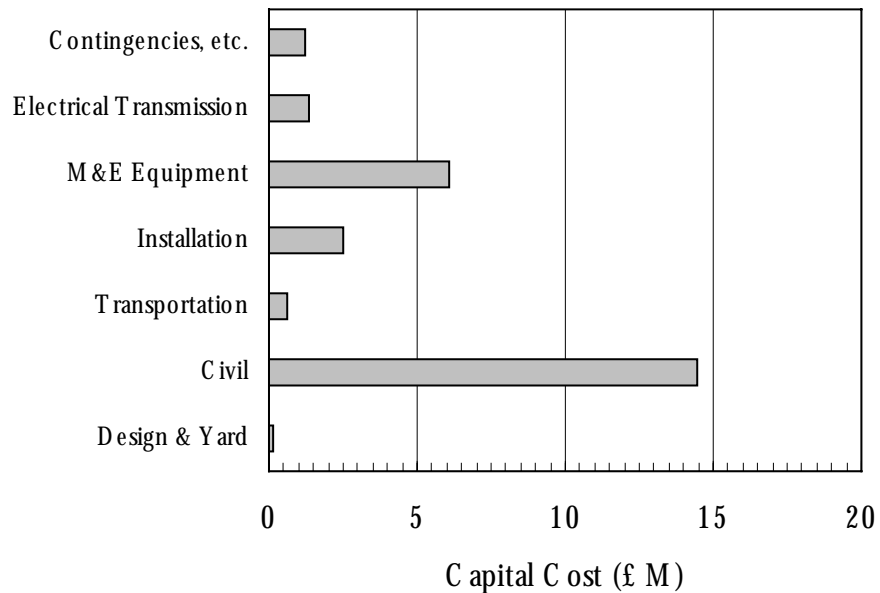
This was carried out for a small-scale scheme consisting of ten OSPREY wind-wave devices. It is likely that more than ten devices would be environmentally acceptable at any one location (some plans for offshore wind farms assume that many more turbines would meet with public approval), but a conservative estimate has been adopted. If more than this number are incorporated in any one scheme, the generating costs will be reduced because

the costs of electrical transmission and connection can be defrayed over a greater electrical output.

**4.5.1 Capital Costs**

The predicted costs of the wind aspects of the scheme were based on the latest costs of offshore wind turbines (Legerton, 1997), with the costs of the base and electrical cabling removed, (as described in Section 4.4). The electrical systems were uprated to take the simultaneous maximum output of both the wind and wave turbines. The resultant cost of the wave energy aspects of the scheme was £ 26.3 M and the breakdown of the costs into the various cost centres has been plotted in Figure 4.4. As described in Section 4.4, the predicted cost for 10 wind turbines was £ 10.5 M, giving a total cost of £ 36.8 M. This is about 10% greater than that estimated by the design team.

**Figure 4.4 Breakdown of Capital Costs for an 10 OSPREY Scheme\***



\* The graph excludes £ 10 M for the wind turbines.

**4.5.2 Availability Of The OSPREY**

The availability of the OSPREY had been calculated previously as ~95% (Thorpe, 1995). Since then, work on the Wells’ turbines and power conversion equipment have led to improvements over the original values (Table 4.1). The new estimate of availability using the same reliability model is 97%.



**Table 4.1 Reliability and Repair Characteristics of Main Components**

Description of Item	Failure Rate (per year)	Repair Time (hours)	Failure Rate (per hour)
<b>Complete turbine set</b>		<b>9.47</b>	<b>0.0002709</b>
Air turbine	0.0190	36.00	2.1689E-06
1.5 kV generator	0.0840	14.00	9.589E-06
Lubrication System		3.05	1.79E-04
Generator-rectifier connection	0.0035	8.9	4.0183E-07
Circuit breaker	0.0036	109.0	4.1096E-07
Rectifier	0.0380	39.0	4.3379E-06
Oil header tank	0.0770	4.0	8.79E-06
Filter	0.5798	2.0	6.6187E-05
<b>Transmission equipment</b>		<b>5.3</b>	<b>1.45E-04</b>
Inverter	0.0960	11.0	1.0959E-05
Inverter-transformer connector	0.0035	8.9	3.9954E-07
Circuit breaker	0.0036	109.0	4.1096E-07
Electrical subsystem		4.5	1.33E-04
<b>Transmission system</b>		<b>125.47</b>	<b>7.763E-07</b>
Circuit breaker	0.0036	109	4.1096E-07
Subsea cable	0.0032	144	3.653E-07

### 4.5.3 Operational and Maintenance Costs

The operational and maintenance costs of the wave energy aspects of the scheme were evaluated as described in Chapter 2.

#### Capital Cost of Spares for the OWCs

The major M&E and transmission cost centres for this analysis are those systems shown in Table 4.2. The one-off cost for supply of spares is predicted to be approximately £ 275 k.

#### Annual Repair Equipment Costs for the OWCs

From Table 4.2 it can be seen that the total annual equipment cost of repair is approximately £ 19 k per device.

#### Annual Operational Costs for the OWCs

The annual repair costs combine the equipment repair costs calculated in the previous Section and the associated labour costs and tug hire rates. The latter are taken from the parametric cost model and the overall repair loadings shown in Table 4.3. The resulting overall annual operational cost is £ 388 k (this includes the operational and maintenance costs of the electrical transmission system for the wind turbines as well).

**Table 4.2 Total Annual Repair Costs for the OWCs**

Item	Failure Rate (per Year)	Environ. Factor	Number in Device	Number of Failures	Cost of Item	Cost of Repair	Spares
Wells' turbine	0.019	2	4	0.152	18,545	£282	18,545
Generator	0.0524	2	4	0.4192	20,000	£838	20,000
Electrical Equipment	0.0142	1	1	0.0142	200,000	£284	200,000
Transformer	0.1245	1	1	0.1245	36,940	£460	36,940
					<b>Total</b>	<b>£18,642</b>	<b>£275,485</b>

### Annual Operational Costs of Wind Turbines

The annual operational and maintenance costs of each 1.5 MW wind turbines outwith the costs described above has been estimated at £36,000 (Legerton, 1997).

**Table 4.3 Annual Repair Loading for each OWC**

Description of Item	Failure Rate (per hour)	MTTF (hours)	MTTR (hours)	Repair Loading (hrs/hr)	No in System	Active only repair loading	Active & transient repair loading (Sea states excluded)	Active & transient repair loading (Sea states included)
Complete turbine set	2.71E-04	3691	9.47	2.56E-03	4	0.0102	0.0124	0.0308
Transmission equipment	1.45E-04	6897	5.30	7.68E-04	1	0.0008	0.0008	0.0008
Transmission system	7.76E-07	1288162	125.47	9.74E-05	1	0.0001	0.0001	0.0001
					<b>Total</b>	<b>0.0111</b>	<b>0.0133</b>	<b>0.0317</b>

### Additional Annual Costs

There are several potential additional costs, the most important of which is insurance. It has been assumed that, for a mature technology, this would amount to 1% of the capital costs or £365,000 for the whole scheme.

### Annual Cost of the Scheme

The total annual costs from all the sources described above is just over £1,110,000 or about £110,000 per device.

#### 4.5.4 Annual Output of the OWC

There are four main aspects to consider in determining the average annual output of an OWC: available wave power, the capture efficiency of the OWC, the efficiency of the air

turbine and the efficiency the power chain (generators, transmission line etc.). These aspects will be now considered separately.

### Available Wave Power

The wave power resource at South Uist has been determined as described in Chapter 2. This average annual sea conditions in 20 m water depth are shown in Table 4.4, corresponding to an average annual power in the sea of 30 kW/m.

The OSPREY is intended to be deployed in water depth of 14.5 m and some of power in the waves will be lost as the waves travel from the 20 m depth contour to this point (Southgate, 1987). The amount of power lost will depend on the nature of the sea bed (e.g. its roughness) and the rate at which it slopes. As a first approximation, it will be assumed that no energy is lost in travelling from 20 m water depth to 14.5 m.

The characteristics of the various sea states summarised in Table 4.4 were entered into a spreadsheet to facilitate evaluation of the overall efficiency of the scheme.

### Capture Efficiency of the Osprey

The capture efficiency of the steel design has been measured in wave tank tests using monochromatic waves (no data have been obtained under real, random sea conditions). These showed that the capture efficiency varied with wave period (Figure 4.5). In order to determine the capture efficiency in real seas, it was assumed that spectral density function,  $\epsilon\{f\}$ , of a single sea state could be adequately described by the Pierson-Moskowitz equation (1964):

$$\epsilon\{f\} = \alpha f^{-5} H_s^{-2} \exp[-\beta f^4] \quad \text{Eqn. 4.1}$$

where  $f$  is the wave frequency and  $\alpha$  and  $\beta$  are constants.

Using the principle of linear superposition (i.e. monochromatic efficiencies may be applied directly to the frequency components in mixed seas), the capture efficiency in a mixed sea,  $C_{ave}$ , is given by the following integral:

$$C_{ave} = \frac{\int \epsilon\{f\} C\{f\} f^{-1} df}{\int \epsilon\{f\} f^{-1} df} \quad \text{Eqn. 4.2}$$

However, it should be noted that there could be significant non-linear effects at high capture efficiencies, which would reduce the accuracy of this approach.

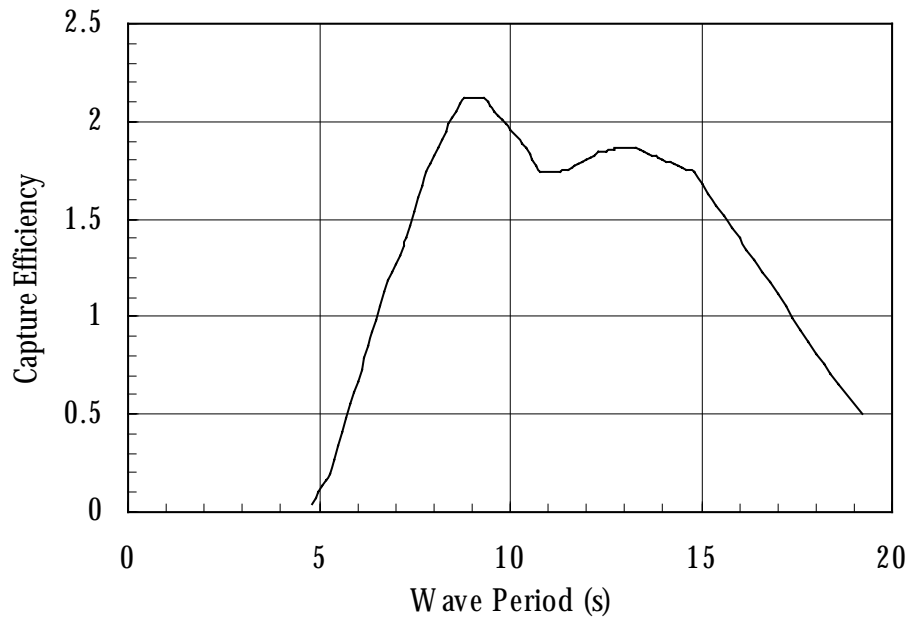
This integration was performed numerically on a computer for each of the sea states listed in Table 4.4 and the annual capture efficiency was calculated to be 126%.

**Table 4.4 Characteristic Sea States for 20m Water Depth Off South Uist**

Wave Height, Hs (m)	Wave Period, Te (s)	Power, (kW/m)	Pi	Weight Wi	P x Wt.
1.50	5.60	6.00	6.00	0.45	2.72
1.30	7.00	5.70	5.70	2.97	16.94
1.50	9.00	10.00	10.00	1.67	16.74
1.50	9.90	11.00	11.00	0.46	5.11
1.80	11.90	19.00	19.00	0.15	2.77
2.70	7.40	26.50	26.50	0.83	21.99
2.50	7.90	24.30	24.30	1.76	42.76
2.00	10.30	20.30	20.30	1.00	20.35
2.10	14.20	30.80	30.80	0.14	4.25
3.60	8.50	54.20	54.20	0.76	41.24
3.30	9.40	50.40	50.40	2.11	106.35
2.70	11.50	41.20	41.20	1.13	46.38
4.40	10.70	101.80	101.80	0.48	49.37
4.30	13.30	121.00	121.00	0.20	24.36
1.80	6.00	9.40	9.40	1.25	11.72
1.30	7.10	6.00	6.00	3.66	21.94
1.70	9.10	12.90	12.90	3.81	49.19
1.20	12.60	8.90	8.90	1.71	15.22
2.90	7.40	30.60	30.60	0.91	27.81
2.60	8.60	28.60	28.60	3.47	99.32
2.30	11.60	30.20	30.20	2.86	86.23
2.20	13.70	32.60	32.60	0.40	13.13
3.90	8.90	66.60	66.60	1.06	70.45
3.60	10.60	67.00	67.00	2.79	187.21
2.30	11.20	29.20	29.20	2.94	85.98
2.90	14.30	59.20	59.20	1.22	72.17
3.60	8.80	56.10	56.10	0.89	49.86
5.30	14.30	197.60	197.60	0.25	49.45
6.90	16.90	395.90	395.90	0.08	31.71
1.80	5.90	9.60	9.60	1.09	10.43
1.60	7.00	9.20	9.20	4.15	38.21
1.60	9.10	11.50	11.50	6.64	76.39
1.50	11.90	13.20	13.20	2.95	38.91
1.60	14.20	17.90	17.90	0.33	5.97
2.70	7.40	26.50	26.50	1.25	33.19
2.50	9.20	28.30	28.30	3.00	84.77
2.70	10.80	38.70	38.70	2.22	86.05
2.90	13.90	57.50	57.50	0.39	22.26
3.60	9.40	59.90	59.90	1.16	69.76
3.60	10.50	67.00	67.00	2.80	187.73
3.60	13.60	86.70	86.70	2.91	252.58
3.70	16.40	110.50	110.50	0.56	62.19
5.10	10.80	138.20	138.20	0.68	93.47
5.70	12.90	206.20	206.20	0.30	61.47
6.00	16.00	283.40	283.40	0.16	46.66
8.80	19.10	727.70	727.70	0.03	22.66
1.60	5.80	7.50	7.50	1.17	8.75
1.10	7.30	4.60	4.60	4.93	22.66
1.30	9.40	7.80	7.80	4.43	34.52
1.10	10.00	6.00	6.00	1.26	7.56
2.20	7.40	17.60	17.60	0.61	10.77
2.50	8.40	25.80	25.80	2.22	57.20
2.90	9.80	40.50	40.50	1.04	42.21
1.80	13.30	21.20	21.20	0.13	2.76
3.00	8.90	39.40	39.40	0.29	11.26
3.60	9.80	62.50	62.50	0.66	41.30
3.00	10.60	46.90	46.90	1.14	53.26

3.60	12.00	76.50	0.79	60.42
4.10	10.20	84.40	0.32	27.13
5.10	11.60	148.40	0.35	51.67
4.90	14.40	170.10	0.29	50.14
8.80	18.10	689.60	0.06	40.65

**Figure 4.5 Capture Efficiency of the OSPREY in Monochromatic Waves**



The capture efficiency in each sea state was entered into the spreadsheet described above. The air power available for conversion by the Wells’ turbine (see next Section) was obtained simply by multiplying the wave energy in each sea state by the calculated capture efficiency.

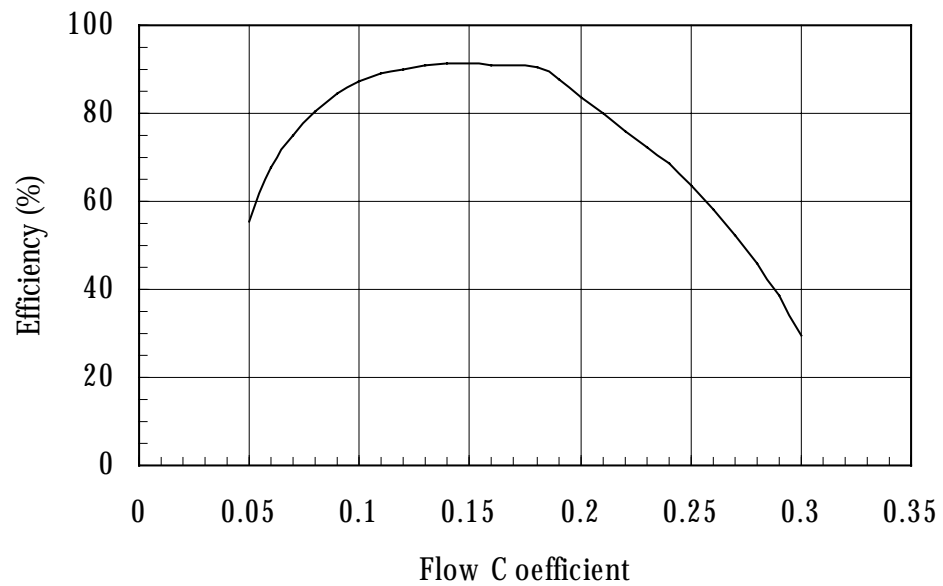
**Conversion Efficiency of the Wells’ Turbine**

The Wells’ turbine is undergoing continuous refinement. The results of tests on a small-scale prototype have been used to predict the characteristics of the full-size turbine. These have been plotted in Figure 4.6 as efficiency as a function of flow coefficient ( $\Phi$ ), which is defined as:

$$\Phi = \frac{2 \times Q}{\omega \times D \times A} \tag{Eqn. 4.3}$$

where Q is the flow rate, D is the diameter of the turbine, A is the annual area upstream of the turbine and  $\omega$  is the rotational speed. This curve is derived from tests on models; its applicability to in-service conditions (where the need to apply sound baffles, etc. could impair performance) has yet to be proved.

**Figure 4.6 Operating Characteristics of the OSPREY Wells' Turbine**



In previous designs of turbine systems considered for wave energy devices (Thorpe 1992), the air flow rate past the turbine would vary both from wave to wave and from sea state to sea state. As a result, the turbine speed and flow coefficient would also vary, leading to large changes in turbine efficiency. In the proposed power scheme for the OSPREY, the control system would govern the turbine speed and air flow using variable vane and pressure release valves. In this case, it is hoped that the flow coefficient can be kept near its optimum, regardless of sea state.

Assuming linear damping operates throughout each cycle, the flow coefficient could be expected to have a Gaussian distribution ( $Z$ ), i.e.

$$Z \left\{ \frac{\Phi}{\Phi_{rms}} \right\} = \sqrt{\frac{2}{\pi}} \exp\left( \frac{-\Phi^2}{2\Phi_{rms}^2} \right) \tag{Eqn. 4.4}$$

where  $\Phi_{rms}$  is the root-mean-square value of  $\Phi$  throughout one wave cycle. Using the variation of efficiency with air flow from Figure 4.6, the average efficiency ( $\eta_{ave}$ ) of the turbine when optimised for the particular sea state is given by:

$$\eta_{ave} = \int \eta\{\Phi\} \sqrt{\frac{2}{\pi}} \exp\left( \frac{-\Phi^2}{2\Phi_{rms}^2} \right) d\Phi \tag{Eqn. 4.5}$$

This integration was carried out numerically on a computer to determine the maximum value of  $\eta_{ave}$  which was found to be 70%. This was adopted as a constant efficiency for all sea states and entered into the spreadsheet described above to determine the turbine shaft power available for conversion to electricity.

**Efficiency Of The Electrical System**

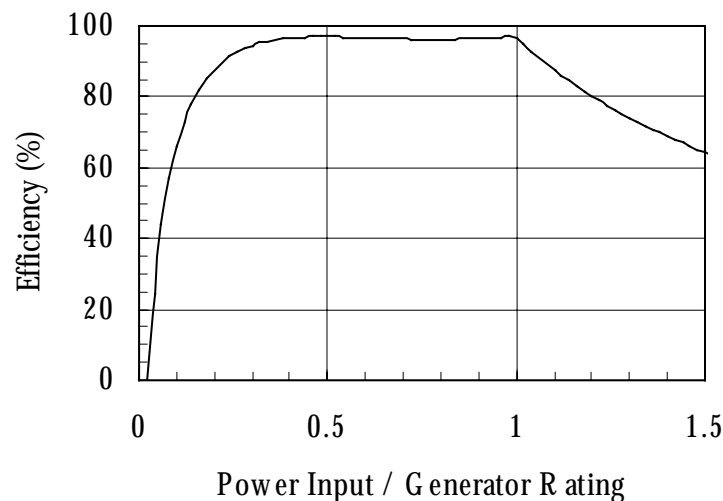
***Generator Efficiency***

The efficiency with which the turbine output was converted to useful electricity was determined using the input power/rating curve for electrical generators shown in Figure 4.7. The annual average efficiency ( $G_{ave}$ ) was calculated using the spreadsheet developed above by multiplying the efficiency ( $G_s$ ) corresponding to the average shaft power in each sea state and the weightings of each sea state as shown in Equation 4.6.

This summation predicted an overall annual efficiency of 95%. The calculated efficiency in each sea state was entered into the spreadsheet to determine the output to be handled by the power control systems.

$$G_{ave} = \frac{\sum G_s \{i\} W_i}{\sum W_i} \tag{Eqn. 4.6}$$

**Figure 4.7 Operating Characteristics of the Generators**



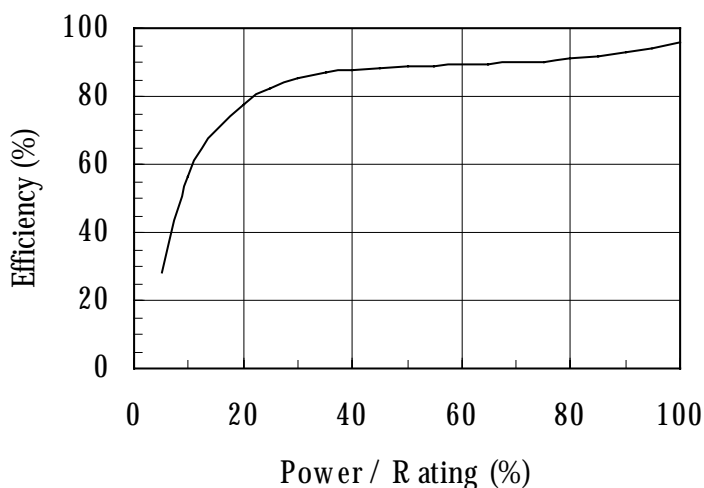
**Power Controller Efficiency**

The use of a power control system would also result in losses in energy conversion. A similar approach to that described above was adopted in evaluating the efficiency of this system. The efficiency/rating curve adopted is shown in Figure 4.8. The resultant annual average efficiency ( $K_{ave}$ ) was calculated using the average generated power in each sea state and the weightings of each sea state:

$$K_{ave} = \frac{\sum K_s \{i\} W_i}{\sum W_i} \tag{Eqn. 4.7}$$

This summation predicted an overall annual efficiency of 90%.

**Figure 4.8 Operating Characteristics of the Power Conversion System**



**4.5.5 Summary of the Annual Output of the OWC**

The various parameters contributing to the determination of the overall power output of a single OSPREY in schemes of various sizes have been listed in Table 4.5. The overall efficiency (i.e. the ratio of electricity output to wave energy intercepted) is 75%.

**4.5.6 Output from the Wind Turbines**

The turbine under consideration is a 1.5 MW device, currently under consideration for deployment in a wind farm off the coast of the UK (Legerton, 1997). Using the manufacture’s data sheets, the performance of this turbine can be estimated.

**Table 4.5 Summary of the Productivity Assessment of the OSPREY**



<b>Parameter</b>	<b>Value</b>
Average Wave Power Level	30 kW/m
Width of Single OWC	24 m
Average Capture Efficiency	126 %
Turbine Efficiency	70 %
Generator Efficiency	95 %
Power Control Efficiency	90 %
Availability	97 %

The electrical output is dependent on the average wind speed, as shown in Table 4.6; the wind speeds chosen represent a widely occurring speed around the coasts (8.3 m/s) and a value which could almost be guaranteed as a minimum, regardless of which site was chosen on the west facing coastline of the UK. In this review, a conservative approach has been adopted by using the lower value, because no cross-correlation has been undertaken between favourable wind and wave sites around the UK, so the use of the higher output cannot be justified.

**Table 4.6 Annual Output of the Wind Turbine**

<b>Annual Average Wind Speed (m/s)</b>	<b>Annual Output (MWh)</b>
7.5	4,103
8.3	4,955

Source: Legerton, (1997).

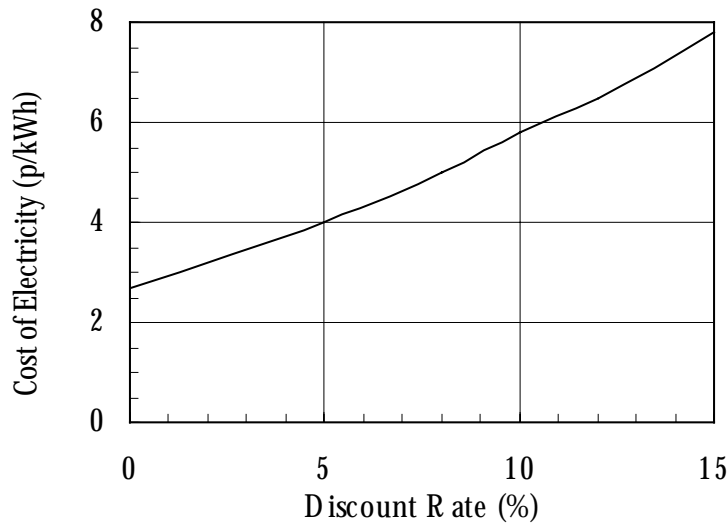
#### 4.5.7 Generating Costs

The relevant results from above were incorporated into a spreadsheet together with the capital cost and O&M data for the wind power aspects in order to calculate the cost of electrical generation. A representative printout of the spreadsheet is shown in Table 4.7. The predicted cost of electricity was calculated for a range of discount rates and the results have been plotted in Figure 4.9. At discount rates of 8% and 15% the scheme is predicted to produce electricity at 5 p/kWh and 7.8 p/kWh respectively.

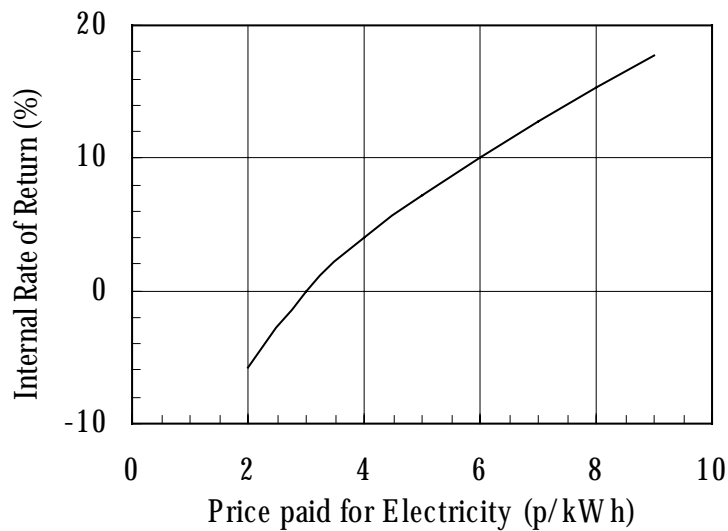
### 4.5.8 Internal Rate of Return

The above values were also used to calculate the internal rate of return for an OSPREY scheme. The results are shown in Figure 4.10 for a range of prices that the generator might be paid for the electricity. The scheme would show a positive rate of return for electricity prices greater than 3 p/kWh.

**Figure 4.9 Influence of Discount Rate on the OSPREY's Generating Costs**



**Figure 4.10 Internal Rate of Return for OSPREY**



**Table 4.7 Example of Discounted Cash Flow Analysis for Electricity Costs**

THE SCHEME		Year	Annual Output (GWh)	Discounted Output (GWh)	Annual Cost (£M)	Discounted Cost (£M)
		0			37.67	37.67
Number of devices	10	1	87.05	75.69	1.18	1.03
Power in the Sea	30 kW/m	2	87.05	65.82	1.18	0.90
Width of Device	24 m	3	87.05	57.23	1.18	0.78
Capture Efficiency	126%	4	87.05	49.77	1.18	0.68
Turbine Efficiency	70%	5	87.05	43.28	1.18	0.59
Generator Efficiency	95%	6	87.05	37.63	1.18	0.51
Control Efficiency	90%	7	87.05	32.72	1.18	0.45
Average Output	5,428 kW	8	87.05	28.46	1.18	0.39
Availability	97%	9	87.05	24.74	1.18	0.34
Annual Output - Wave	46.05 GWh	10	87.05	21.52	1.18	0.29
Annual Output - Wind	41.00 GWh	11	87.05	18.71	1.18	0.25
Total Output	87.05 GWh	12	87.05	16.27	1.18	0.22
		13	87.05	14.15	1.18	0.19
		14	87.05	12.30	1.18	0.17
Discount rate	15 %	15	87.05	10.70	1.18	0.15
Capital cost	36.81 £ M/scheme	16	87.05	9.30	1.18	0.13
Cost of spares	0.86 £ M/scheme	17	87.05	8.09	1.18	0.11
O&M rate	1.18 £ M/year	18	87.05	7.03	1.18	0.10
		19	87.05	6.12	1.18	0.08
		20	87.05	5.32	1.18	0.07
		21	87.05	4.62	1.18	0.06
		22	87.05	4.02	1.18	0.05
<b>Cost of electricity</b>	<b>7.9 p/kWh</b>	23	87.05	3.50	1.18	0.05
		24	87.05	3.04	1.18	0.04
		25	87.05	2.64	1.18	0.04
		26	87.05	2.30	1.18	0.03
		27	87.05	2.00	1.18	0.03
		28	87.05	1.74	1.18	0.02
		29	87.05	1.51	1.18	0.02
		30	87.05	1.31	1.18	0.02
		31	87.05	1.14	1.18	0.02

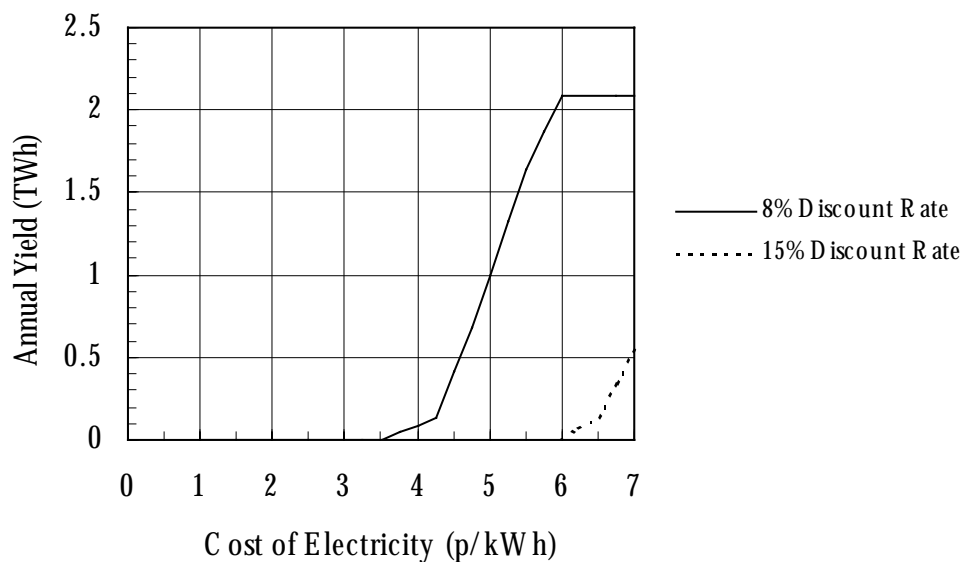
## 4.6 RESOURCE-COST CURVES

There are a number of ways in which the cost of electricity from this scheme could be varied but the most important factor is the incident wave energy. Simply increasing the amount of energy captured does not necessarily bring about a proportional decrease in electricity costs,

because higher wave power levels might require modifications to the structure and changes to the ratings of the components. Therefore, an accurate assessment of the potential would require a detailed re-design. A simplified approach has been adopted in order to give some indication of the potential effects of different wave climates. In this, it has been assumed that the structure remains the same and that changes in the power levels effect only the efficiencies and costs of the power chain (i.e. turbines, generators, etc.). This was modelled for different power levels, again trying to optimise the scheme.

The resulting relationship between generating cost and wave power level was applied to the nearshore resource for 26 of the most promising nearshore sites around the UK (Whittaker *et al*, 1992b). This produced the cost-resource curve shown in Figure 4.11.

**Figure 4.11 Cost-Resource Curves for Existing OSPREY**



It should be emphasised that these curves are conservative (with respect to the size of resource exploitable at a given cost), because a low estimate has been taken of the visually acceptable numbers of devices (i.e. a total of 26 sites around the northern and western coasts of the UK each with 10 devices). Exploitation of more sites will increase the maximum resource shown in Figure 4.11, albeit at higher generating costs. This is an important factor to consider in strategically exploiting the UK’s coastal energy resource. To some extent, offshore wind and wave energy schemes compete for the regions of sea bed on the western side of the UK that could be acceptably exploited. It is likely that only a limited number of schemes will prove visually acceptable. If such sites are exploited by a hybrid scheme such as the OSPREY, then this would increase the maximum energy production from publicly acceptable renewable energy schemes.

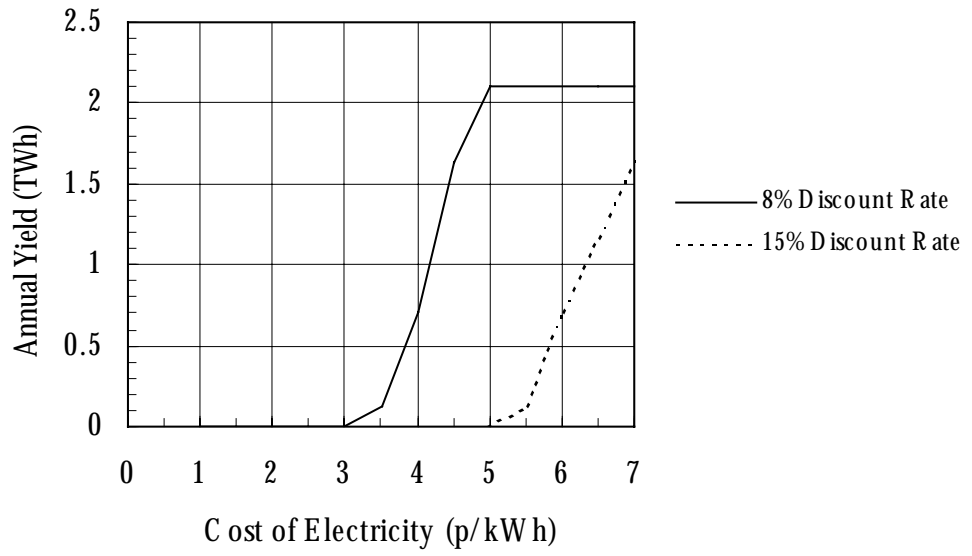
## 4.7 POTENTIAL COST REDUCTIONS

There are several areas where cost reductions are possible:

- **Capital costs.** The main cost centres are the civil structure costs and the mechanical and electrical plant. The structural costs could be reduced by ~ 13% if the fabrication were streamlined. Further reduction in costs is possible by using alternative construction techniques. Wavegen are currently investigating the use of SHOTCRETE (a proven method of spraying concrete to cover curved sections) and BISTEEL (a novel steel/concrete/steel sandwich). However, the implications of these techniques can not be quantified as yet, though they are likely to be substantial.
- **Turbine efficiency.** The current design for the first device uses fixed pitch blades, resulting in an overall turbine efficiency of 70%. The addition of flow stabilisers is estimated to increase the turbine efficiency to ~ 75%. Variable pitch blades are being considered for follow-on devices. In these, the pressure on the nose cone of the Wells' turbine assembly can be used to vary the pitch of the blades using a tension-torsion bar (similar to that used to control the pitch of helicopter rotor blades). This would ensure that the blades adopt an optimum angle of attack (and, hence, higher efficiencies of ~ 85%) across a wide range of air flows. It is a proven technology, which could be adapted for a small increase in capital costs - an estimate of 25% is thought adequate to cover this.
- **Power controller efficiency.** The power controller efficiency has been estimated as 90%, based on information available. However, Wavegen have been working with the manufacturers to improve this equipment and they expect an average efficiency of 95%.

If all these improvements are achieved, there would be a cost reduction for the scheme under consideration to 4.3 p/kW at 8% discount rate and 6.6 p/kWh at 15% discount rate, resulting in the resource-cost curves shown in Figure 4.12. As noted above, there could be further improvement in the future costs of electricity from the OSPREY2 arising from different construction techniques.

**Figure 4.12 Cost-Resource Curves for a Developed OSPREY**





## 5 Offshore Wave Energy - the Duck

### 5.1 INTRODUCTION

The approach adopted by the Edinburgh University team was to develop a wave energy device (the Duck), which would exploit the maximum amount of the wave energy resource available in deep water. This required the Duck to operate under more energetic wave regimes, which would place great technical demands on the device. The Edinburgh team has acknowledged that the Duck would require a long R&D programme, stating that it is a second generation device. However, in acknowledging the long time scale for the development of the Duck, the team has not limited itself to current engineering practices and technologies. Instead it has produced a design which incorporates both novel features and extrapolations of conventional engineering practice both of which would require significant R&D before they could be realised.

The former review of UK wave energy (Thorpe, 1992) assessed two designs of the Duck:

- The 1983 Duck (Edinburgh, 1979), which was developed under the UK Wave Energy Programme (ETSU, 1985);
- The 1991 Duck which was an improved design developed as a response to the wave energy review.

The review also identified a number of potential problem areas, which would require further R&D if the Duck was to be successful. As a response to this, the design was extensively revised producing the current version - the 1998 Duck. In addition, the Edinburgh team has been developing some of the novel mechanical plant required for the 1998 Duck.

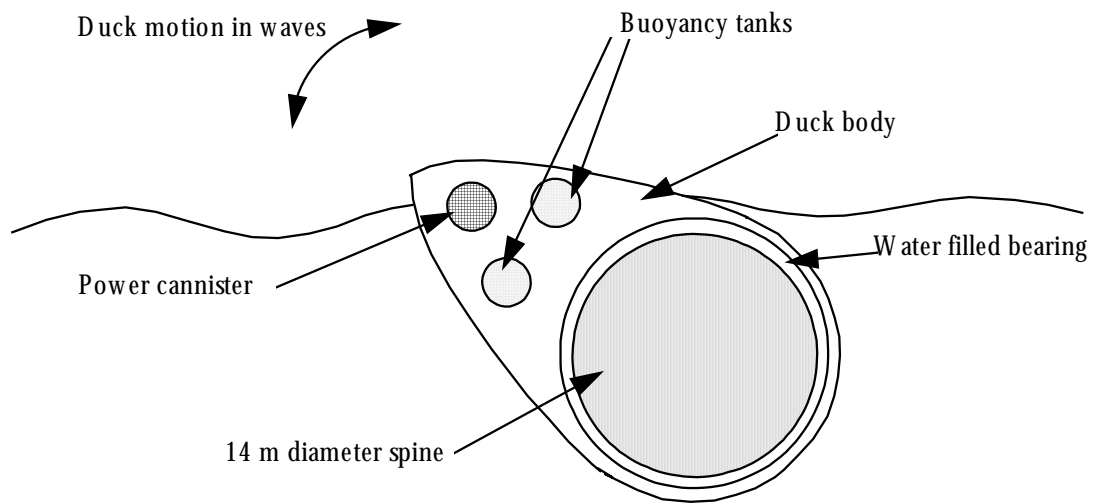
This Chapter will review briefly the two earlier versions of the Duck before going on to assess the 1998 Duck in more detail.

### 5.2 THE 1983 DUCK

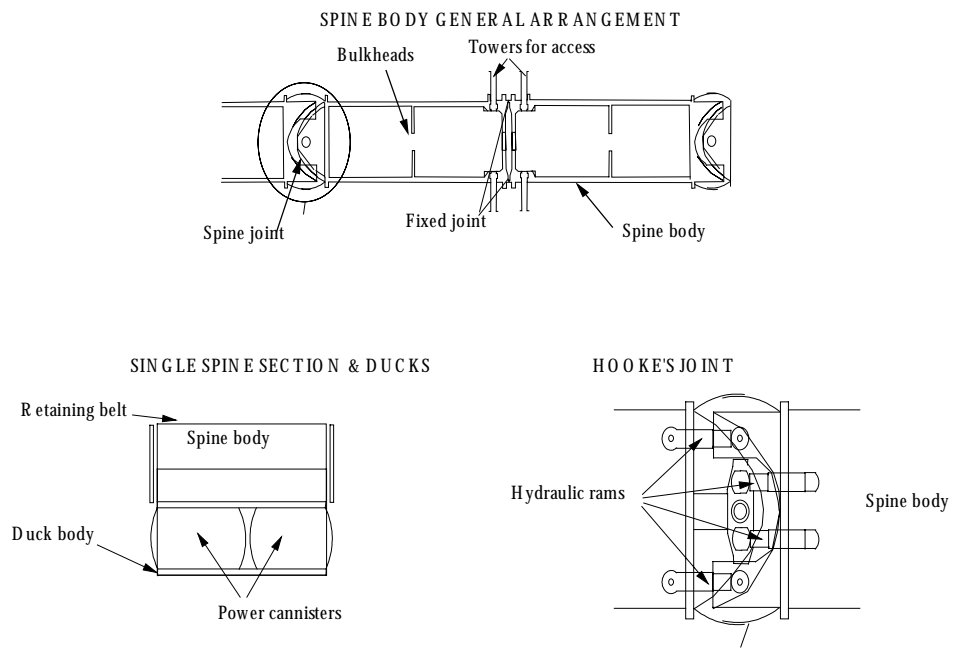
The 1983 design for a 2 GW Edinburgh Duck wave power scheme consisted of eight spine strings each comprising 54 floating concrete cylinders or spine sections, which were moored in 100 m water depth via flexible tethers (Figure 5.1). Two Duck bodies were attached to each spine section by a retaining strap, which allowed the Duck to rotate around the spine and to nod in response to waves (Figure 5.2). The hydraulic rams mounted in the joints between each

#### **Figure 5.1 Outline of the 1983 Edinburgh Duck**



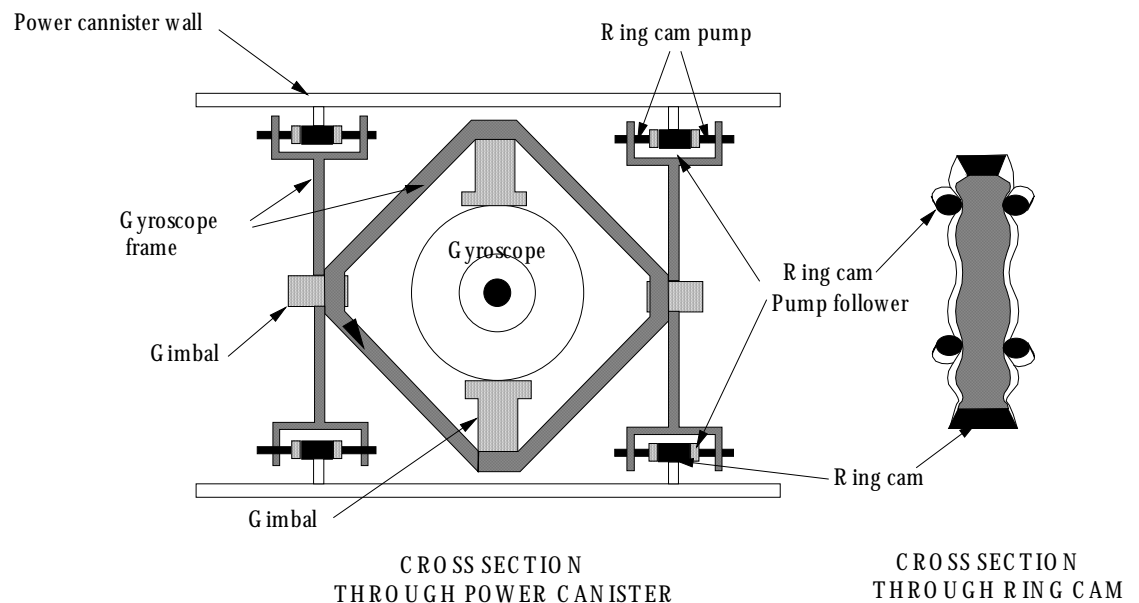


**Figure 5.2 Main Features of the Duck-Spine Assembly**



section of the spine (Figure 5.3) allowed the whole spine to flex in stormy conditions. Every Duck body contained two independent power canisters, each of which was a completely sealed unit containing the main mechanical and electrical plant in a controlled, low pressure environment (Figure 5.3). In order to generate power, the nodding motion of the Duck was reacted against a reference frame provided by two gyroscopes which were fixed to a gimbal-mounted frame within each power canister.

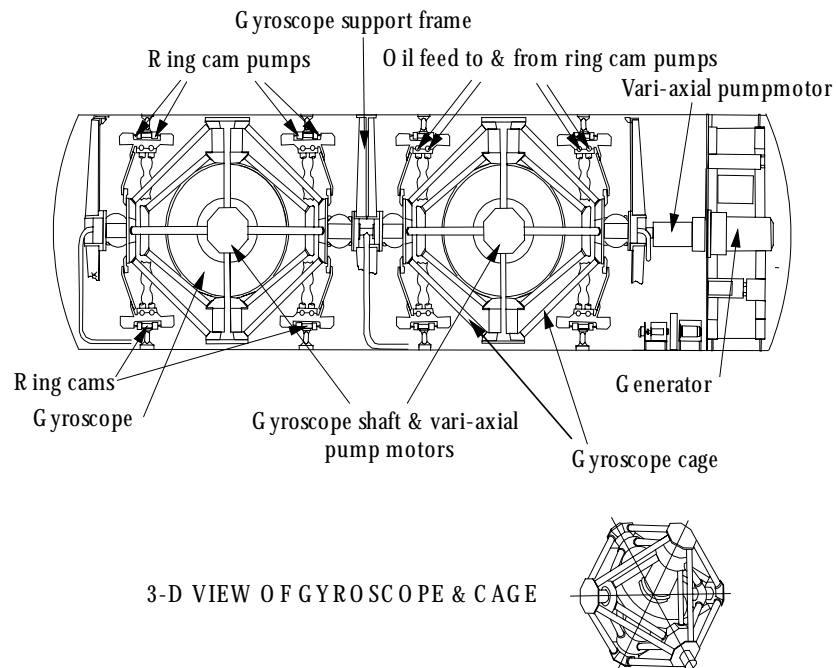
**Figure 5.3 Schematic of the Gyroscope and Ring Cam Pump Assembly**



A series of ring cam pumps was attached to the gyroscope frame, whilst the ring cam which operated these pumps was fixed to the power canister wall (Figure 5.4). As the Duck nodded, the gyroscopes, gimbal frame and pumps moved with respect to the power canister wall and ring cam. This resulted in each pump travelling over a section of the sinusoidal profile of the ring cam, which generated a pumping action thereby feeding oil to a high pressure hydraulic ring main.

This hydraulic ring main fed several vari-axial motor/pumps, which were connected to both the gyroscope and an electrical generator. This assembly of motor/pumps allowed energy to flow to and from the gyroscopes, which provided energy storage. This enabled the varying power levels within a sea state to be smoothed out, providing a steady input to the electrical generator motor. The synchronous electrical output from each generator was transformed to 3.3 kV and fed to a bus running along the centre of the spine by means of a ribbon cable

**Figure 5.4 Outline of a Duck Power Canister**



mounted on a reeling mechanism, which accommodated the relative motion between the Duck and the spine.

Power canisters within the spine also generated power using oil from the rams operating the spine joints. The output from the Duck and spine power canisters was aggregated along the length of the spine and transformed at various points within the spine to 33 kV and 132 kV before transmission to shore.

### 5.2.1 Assessment of the 1983 Duck

#### **Technical Assessment**

A technical assessment of this design revealed a number of potential problems which would have to be resolved if the design was to prove technically viable (Thorpe, 1992).

#### **Economic Assessment**

The costs, operating characteristics and generation costs of the 1983 Duck were agreed with the Edinburgh team and are summarised below.

**Capital Costs**

The total parametric cost of a 2 GW scheme deployed in a favourable location to the west of South Uist was £ 6.3 B or £ 7 M per Duck. The breakdown of the overall costs for the South Uist scheme into the various cost centres has been plotted in Figure 5.5, which shows that the major cost items are those associated with the device M&E equipment and fabrication of the civil structure of the Duck.

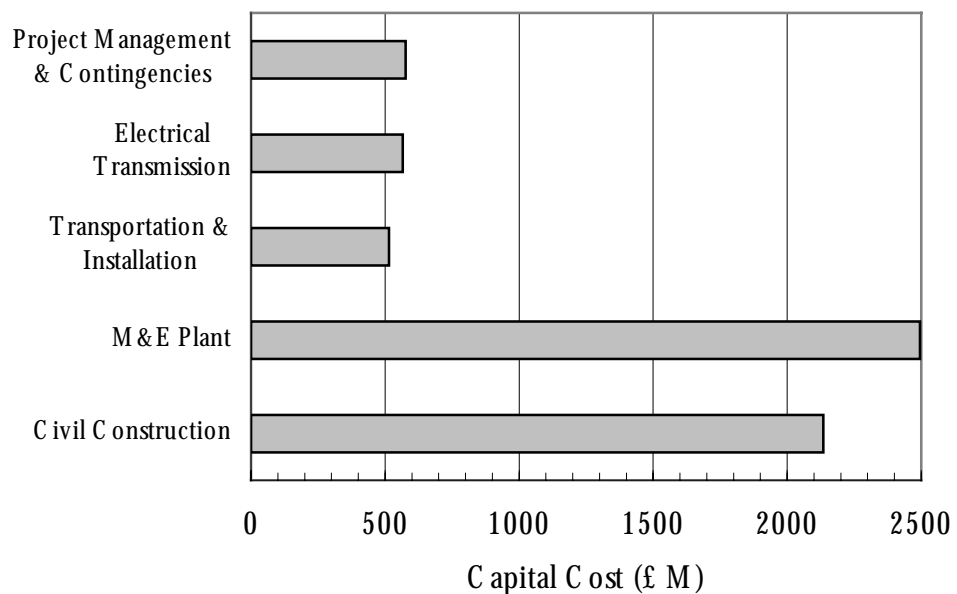
**Operation and Maintenance Cost**

The annual operation and maintenance costs for the whole scheme were £ 197 M.

**Operational Characteristics**

The main operational characteristics for the 1983 scheme are listed in Table 5.1. The resulting generating costs were 57 p/kWh at 8% discount rate and 83 p/kWh at 15% discount rate.

**Figure 5.5 Capital Cost Breakdown for the 1983 Duck**



**5.3 THE 1991 DUCK**

The low availability predicted for the 1983 design led to discussions with the Edinburgh team in order to identify and quantify possible improvements to the design. These discussions and more recent work were incorporated into the wave power scheme and led to what was termed the “1991 Duck”.

**Table 5.1 Operational Characteristics of the 1983 Duck**

Average Wave Power Level	71.6	kW/m
Directionality Factor	0.9	
Width of Single Duck	45.0	m
Average Capture Efficiency	41.9	%
Hydraulic Efficiency	93.5	%
Generator Efficiency	95.2	%
Transmission Efficiency	93.3	%
Availability	16.2	%

### 5.3.1 Outline of the Changes to the 1983 Duck

The main changes were:

- **Access to the Spine for Repair.** The availability analysis indicated difficulty in gaining access to the wave power station during stormy weather (i.e. additional transit and waiting time). This situation could be improved by adopting the conventional offshore practice of having repair and maintenance crews stationed permanently on the Duck spine. This could be accomplished by having an additional spine unit at either end of the spine (two units being required for safety). This would guarantee year-round access to the spine and reduce transit time to any fault on the spine. Changes of crew and renewing supplies could be carried out by vessels in suitable weather windows.
- **Power Canister Replacement.** In the 1983 design, the failure of a power canister would necessitate the removal and replacement of a complete spine section, with the problematic making and breaking of spine joints at sea. It was estimated that this complex operation would (if possible) take some 150 hours, during which time the power supply along the 33 kV spine bus would be interrupted. An alternative strategy would be to develop a system for removal of the power canisters from the Duck. The independent consultants agreed that, within the time scale for development of the Duck, such a change could be achieved. This would reduce the replacement time to 12 hours and avoid interruption of the 33 kV bus spine supply.
- **Ring Cam Pump Design.** Work on the design of the ring cam pumps carried out since 1983 resulted in a lighter design with improved working characteristics. The failure rate and redundancy of these units made them a non-critical item in the availability analysis and so no improvement in availability would result. However, a reduction in cost of 50% was considered attainable with further design refinements.
- **Power Canister Shaft Seal.** The Edinburgh team proposed the use of a “ferrofluidic” seal on the shaft leading to the power canister generator. This seal helps to maintain the difference in atmosphere between the mechanical and electrical compartments of the power canister. It was agreed that, following substantial development of this type of seal, some benefit could be given in terms of improved reliability.
- **Spine Joint Hydraulic Rams.** In the 1983 design, failure of the hydraulic rams would require removal and replacement of an entire spine section, with serious consequences

for system availability. It was agreed that a system of individually demountable hydraulic rams could be developed, which would allow replacement of the rams at sea. This would have a significant benefit for availability with no increase in the overall costs since this modification would dispense with the expensive steel shrouds around the spine joints.

- **Spine String Power Take-Off.** In the 1983 design, each spine string has a single 33/132 kV transformer which is fed by a single 33 kV bus running the length of the spine. A major consequence of this is that removal of any spine section for repair would entail loss of power generation not only from the removed unit but also from all those units on the opposite side of the faulty unit from the transformer and downfeed to the sub sea cables. This situation could be improved by having a 33/132 kV transformer at each end of the string, which are connected by duplicated subsea cable loops. This modification was incorporated in the 1991 design.

### 5.3.2 Implications of Changes to the Duck

The modifications incorporated in the 1991 Duck design led to:

- A significant increase in predicted availability from 16.2% to 52.9% (most of this improvement resulted from the inclusion of the redundant spine string power take-off scheme);
- A small reduction in the overall capital cost from £5.7 B to £5.6 B (excluding project management & contingencies), with the savings on the moorings being offset to some extent by increased transmission costs resulting from the redundant spine electrical scheme;
- A reduction in annual O&M costs from £197 M to £76 M and in capital replacement costs from £63 M to £45 M. This resulted from the on-board stationing of repair crews, the ability to remove power canisters and the serviceability of the hydraulic rams in the Hooke's joints.

The resulting generating costs were reduced significantly to 17 p/kWh at 8% discount rate and 26 p/kWh at 15% discount rate.

## 5.4 THE 1998 DUCK

Following the wave energy review, the Edinburgh team rapidly addressed the deficiencies and potential problem areas, bringing about a radical redesign of the Duck (Salter, 1993). The implications of these changes were assessed only recently, which has led to this design being termed the 1998 Duck. There were significant changes to the following areas:

- The routing of the electrical transmission cabling;
- The power take-off;
- The Hooke's joints between spine sections;

### 5.4.1 Transmission Cabling

The need to make and break the cabling along the spine length when repairs to a Duck were being carried out led to the unacceptably low availability of the 1983 Duck. The double

electrical downfeeder of the 1991 design led to a significant improvement but still over 40% of the available energy was being lost when repairs had to be carried out to two Ducks in a single spine (i.e. all the energy that could have been generated by the Ducks between the two repair points could not be transmitted).

The Edinburgh team proposed a new cable transmission system to overcome this problem. The original 33 kV cable passed along the centre of the spine, to avoid bending. The new system would pass through a hinged bridge between the spine sections (Figure 5.6). This arrangement would allow a repair ship to bring the connections either side of a faulty spine section, thereby maintaining electrical transmission during removal or repair of the faulty section. This modification would increase the overall availability and allow easy movement of repair crews from section to section.

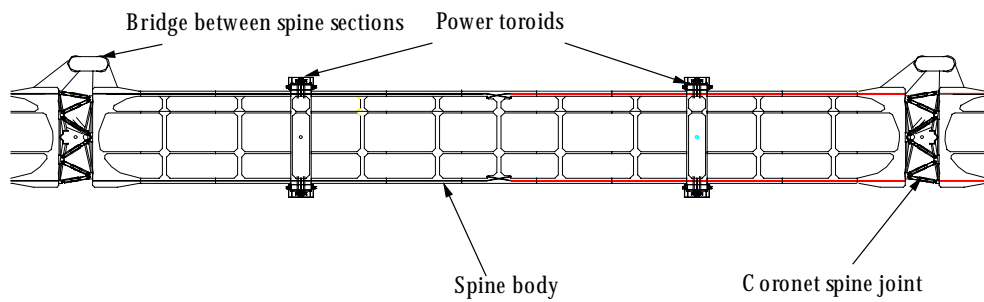
#### 5.4.2 Power Take-off

The complex power take-off of the 1983 and 1991 designs has always been a controversial area (e.g. ETSU, 1985). The 1992 review demonstrated that, even if the complex system of gyroscopes and ring-cam pumps operating in a vacuum was reliable, removal of the power canister for repair was costly and led to reduced availability. In addition, the gyroscope bearings resulted in limitations on the maximum power (torque) that a Duck could handle, leading to wasteful spillage of energy from powerful sea states.

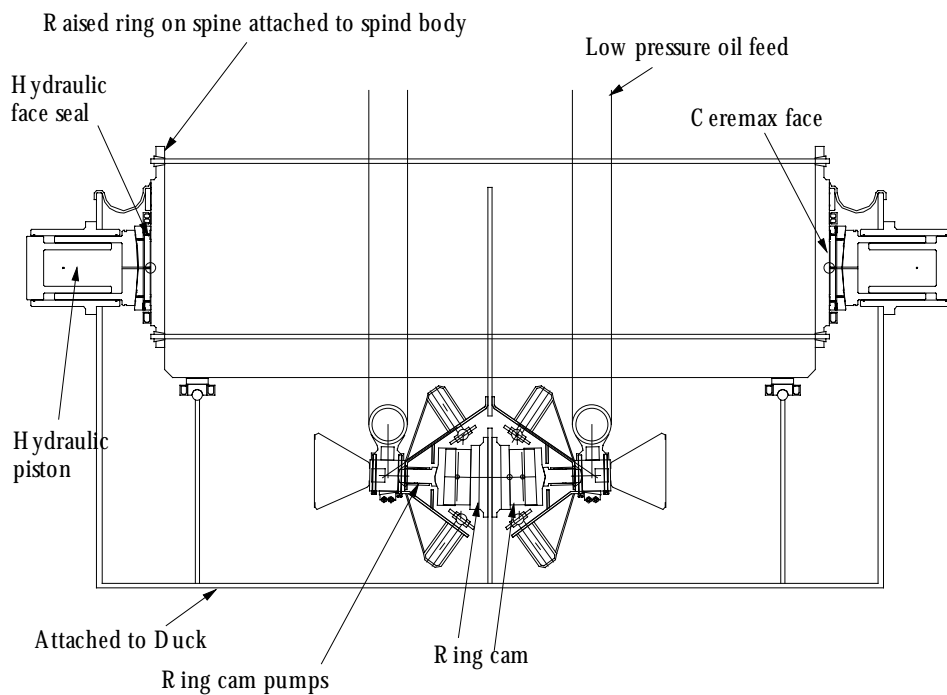
At about this time, a new ceramic coating (Ceremax) came onto the market. This allowed parts that were coated with this substance to operate for long periods in sea water without corrosion or fouling. After learning of this development, the Edinburgh team abandoned the power canister and its components in favour of a simpler, single ring-cam system within a power toroid in the middle of each Duck (Figure 5.6). The actual power take-off from the ring-cam pumps is shown in more detail in Figure 5.7).

The annular mid-plate and raised ring are attached to the spine, with the mid-plate carrying 388 ring cam pumps arranged in an annulus. The ring cam is fixed to a plate, which is attached to the Duck beak and so it moves back and forth with respect to the ring cam pumps as the Duck “nods”. This movement activates the pistons of the ring cam pumps, thereby supplying hydraulic oil to a high pressure manifold.

**Figure 5.6 New Spine Design and Hinged Bridges for the 1998 Duck**



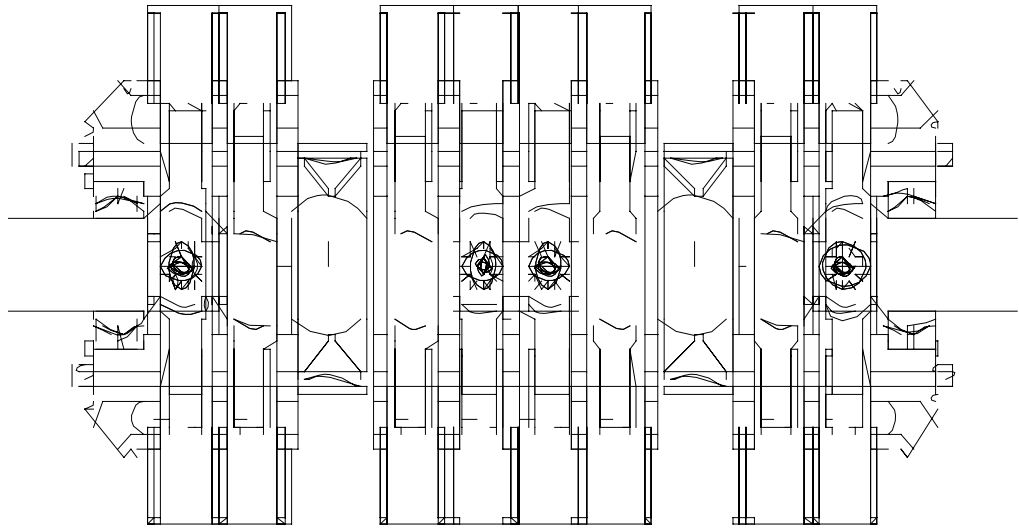
**Figure 5.7 Power Toroid for 1998 Duck Design**



This is an elegant assembly, whose cost increases as the sum of the number of ring cam lobes and ring cam pumps but whose output increases as the product of these two values. The high pressure oil from these pumps (and also from the spine joints) is fed in to a “wedding-cake” digital hydraulic pump motor (Figure 5.8).



**Figure 5.8 The “Wedding Cake” Hydraulic Unit**



The system is composed of annular “slices” arranged around a central lobed cam. Each slice can control the supply and output of hydraulic oil using computer controlled poppet valves. This allows the device to accept varying input power levels and to deliver power to a constant speed device, such as an electric generator.

This device is the key to the power take-off system and has undergone considerable development and testing (CEC, 1993; Salter and Rampen, 1993; Rampen *et al*, 1995).

This system has several advantages over the old power take-off, including:

- The larger ring-cam pump system can handle higher torques, so it can recover more energy from powerful sea states.
- The system is considerably cheaper than the old design, due to the exclusion of much of the expensive, sophisticated hydraulics.
- There are enough ring cam pumps to provide redundancy, so the failure of one does not affect power take-off.
- Most (if not all) of the mechanical plant is now accessible, so repairs or replacement can be carried out *in situ*.
- The wedding-cake system allows simultaneous hydraulic control over a number of hydraulic pumps and rams (see Section 5.4.3).

#### 5.4.3 Spine Joints

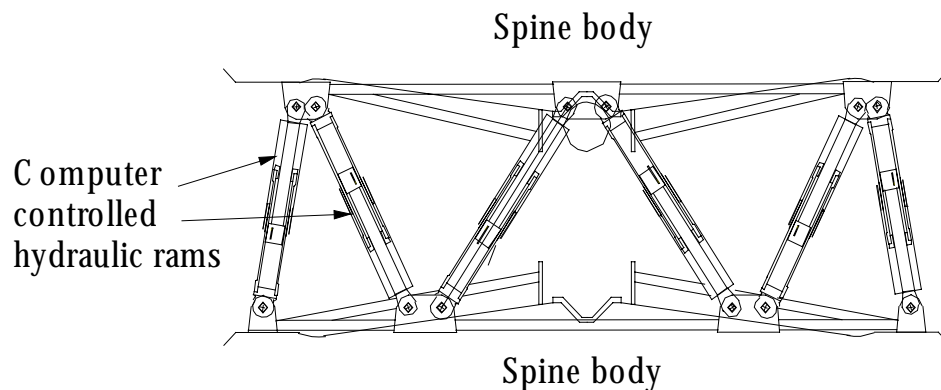
The Hooke’s joints between the spine sections in the earlier designs (Figure 5.2) were difficult to construct and protect from sea water (they required a heavy steel shroud and rubber seals). In addition, they imposed a maximum length on the spine section, because of the limited bending moment that they could absorb.

As noted above, Ceremax coating can now allow hydraulic rams to operate for long periods in sea water without any additional protection. This removes the need for the expensive steel shrouds on each spine section.

The advances represented by the Ceremax coating and the “Wedding Cake” have enabled the Hooke’s joint to be replaced by the “Coronet” joint (Figure 5.9). This joint distributes loads around the end of the spine section more efficiently than a Hooke’s joint, allowing it to absorb higher bending moments. This permits the use of a greater spine section length (124 m compared with 90m), which has a knock-on effect on the total number of M&E units and mooring lines.

In addition, the ability to control the movements of the Duck (as opposed to just absorbing the bending moment) enables complex conjugate control to be exercised over the Duck (Nebel and Woodhead, 1993). This should enable the scheme to increase its effective capture efficiency.

**Figure 5.9 The Coronet Assembly for Connecting Spine Sections**



## 5.5 TECHNICAL COMMENTS ON THE 1998 DUCK

A detailed technical assessment is well outside the scope of this review. However, some of the main technical aspects have been addressed briefly below.

### 5.5.1 Civil Structure

There are three key aspects of the civil structure: the spine and Duck bodies as well as the bearing between the Duck and spine.

### ***The Spine Body***

Little detail is given concerning the fabrication methods proposed for the spine. The new design of spine is composed of a number of sections, each containing internal bulkheads.

This design offers a number of advantages over the earlier concept:

- It avoids the need to break the joints between spine sections, which would have been difficult (if not impossible) to do when required for repair of an individual Duck.
- The internal bulkheads reduce the likelihood of catastrophic flooding in the event of a wall breach.
- The separate sections will be easier to fabricate than the former spine half sections. However, they will need to be joined together. It is likely that this will be achieved using conventional MacAlloy bolts; these will have to be protected from contact with sea water.
- The replacement of the Hooke's joints by the "Coronet" results in a more uniform stress being applied to the spine body, enabling the use of less bulky sections.

The construction necessitates the handling of large items (e.g. each spine section assembly can be post-tensioned together). This will require the development of facilities for this novel technique. (See also Section 5.5.2).

### ***The Duck Body***

The Duck body is a buoyant cellular structure, slip-formed from reinforced and prestressed concrete using Lytag lightweight aggregate. One side of the body forms the "beak" of the Duck whilst the other has a concave semi-cylindrical shape which follows the outer contour of the spine. Each Duck body is 45 m long with a maximum 14.4 m diameter with walls of 0.424 m thickness. The longitudinal voids within the structure provide buoyancy.

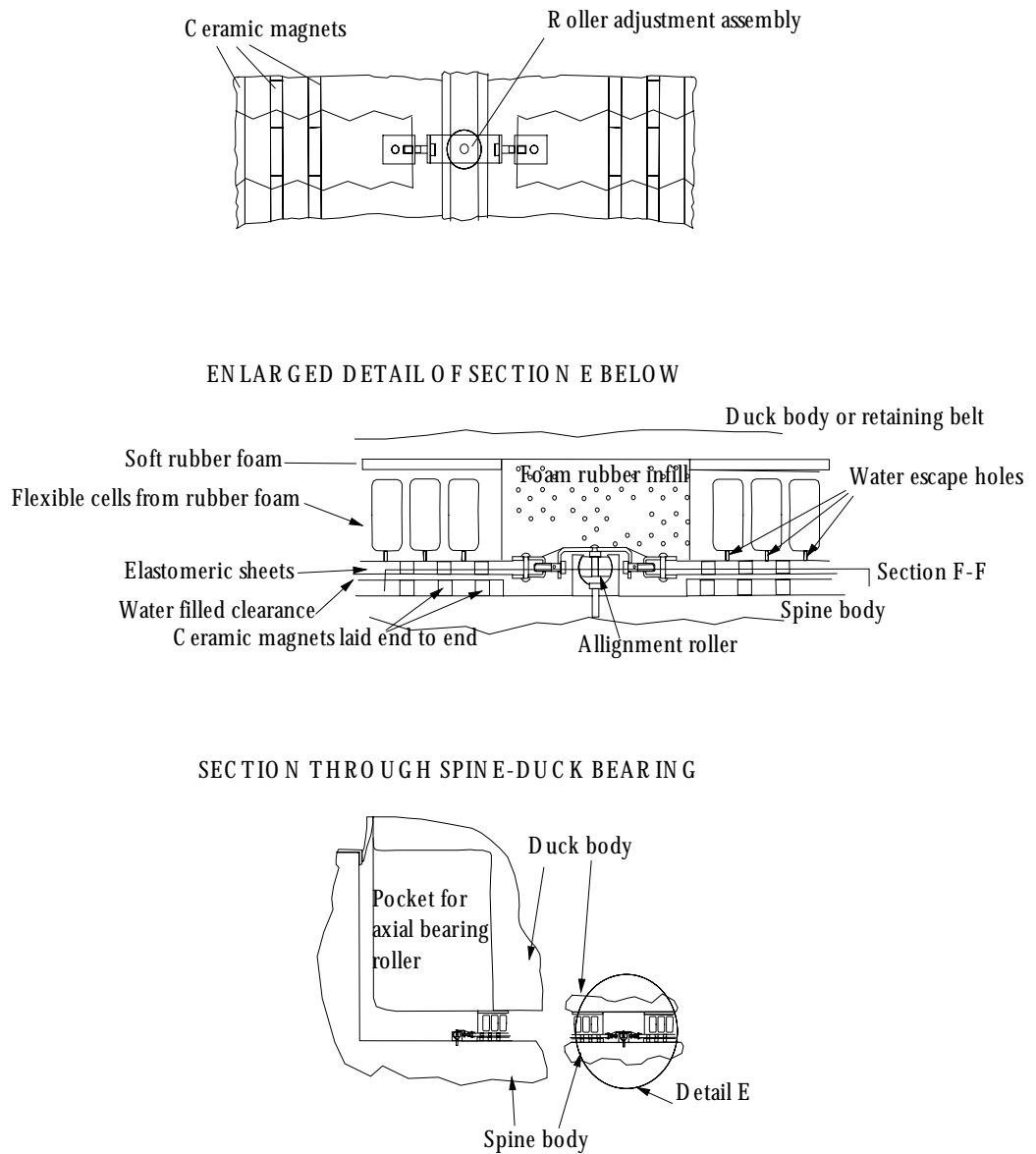
There are some potential problem areas.

- Simple assessments indicate that the design appears to be adequate for service conditions but a more detailed finite element analysis would be required to account for the complex interior geometry of the body.
- Achieving adequate buoyancy in the Duck body using conventional construction materials has proved a problem. This has led to the adoption of Lytag aggregate for the concrete but this would require evaluation of its long term performance in sea water.

### ***The Duck-Spine Bearing***

The Duck body is held around the spine by a series of overlapping, heavy duty reinforced rubber belts. In order to avoid a large loss of power in the bearing between the Duck and spine bodies and also to reduce the forces applied by the Duck to the spine, a novel magnetically assisted squeeze film bearing has been proposed. This bearing is 14 m in diameter and approximately 45 m long, with a cross section as shown in Figure 5.10.

**Figure 5.10 The Duck-Spine Slubber Bearing**  
 RADIAL VIEW OF SPINE-DUCK BEARING



During normal service (i.e. varying pressures being applied across the bearing) the two halves of the bearing are kept apart by the sea water film, which has a long leakage path. However, during quiet periods the sea water film within the bearing could become exhausted, in which case separation is maintained by the repulsion between the two layers of barium ferrite magnets. One set of magnets is fixed to a thick layer of flexible foam rubber or

plastic cells, the slubber. This is intended to accommodate any radial displacements between the Duck and spine including stress induced deformations. The relative alignment of the repelling magnets on the Duck and spine is unstable and so roller bearings are positioned periodically down the length of the bearing to couple the axial movement of the Duck magnets to those mounted on the spine. In order to avoid fouling, chlorine is generated by use of slow acting pellets contained at the edges of the bearing.

Radial forces on the bearing result in low pressures (because of the large, load bearing areas). Any axial forces (e.g. from waves travelling along the length of the spine) are resisted by the power toroids (see next Section).

A planar squeeze film bearing has been developed and tested at Edinburgh University at a small scale (Anderson, 1985). However, deploying a Duck-size bearing will require a special facility (see next Section) and further work will be required to prove an adequate service life.

### 5.5.2 Mechanical and Electrical Plant

In comparison with the earlier designs, the M&E plant on the 1998 Duck is much less complex and utilises more proven technology. In addition, moving this plant to within the spine body makes it easier for access and repair as well as avoiding the potential problems incurred by trying to transmit electricity between a moving Duck beak and a stationary spine section. Where novel equipment is required (e.g. ring cam pumps and the Wedding Cake hydraulic motor), the Edinburgh team has undertaken considerable in-house development and is ready to commercialise several pieces of technology. The long term reliability of this equipment needs to be demonstrated together with its ability to handle the complex oil flows from the Coronet and the power toroid.

Potentially the most significant problem is ensuring that the power toroid remains water tight. The design intends to achieve this by a number of hydraulic pistons forming a sliding seal against the raised ring on the spine body (see Figure 5.7). This requires that the annular face of this ring be flat (over a diameter of  $\sim 15$  m) and corrosion resistant. The latter is ensured by using Ceremax coating. However, ensuring a flat sealing face requires a novel fabrication process. The Edinburgh team propose handling a spine section as a workpiece on a very large lathe. The spine section would be held between turning centres at its two ends and rotated about these centres. This would allow a grinding tool to produce a flat face on either side of the raised ring. This system would also be used for laying down the Duck-spine slubber bearing.

The scaling up of workshop techniques to this size will be an interesting challenge.

### 5.5.3 Transmission System

The transmission system for the 1998 Duck has not been specified in detail. However, it is expected to be similar to that for the 1991 Duck, except that there is no need for the problematic Duck-spine reeling system. The potential problems facing this scheme have been described in the earlier review (Thorpe, 1992).

#### 5.5.4 Transportation and Installation

Following the assembly of a spine section, the spine would be floated in a dock where it would be mated with its Ducks. The mated Duck-spine sections would then be towed to a sheltered inshore site, where they would be positioned ready to be joined to others. These units are initially winched towards each other but final coupling is carried out using hydraulic latches. This will be repeated until the requisite length of spine has been formed.

The moorings required by this length of spine would be fitted at this inshore location. These consist of 100 mm diameter parafil or 60 mm thick PVC-coated steel wire rodes connecting the spine to clump anchors. These will be of two weights: 240 tonnes and 120 tonnes for the seaward and shore-facing anchors respectively. Each rode will also contain a buoy and sinker providing 25 tonnes or 100 tonnes of lift/drag on the shore-facing and seaward sides respectively. This arrangement produces a highly compliant mooring scheme.

This assembly is towed to the pre-surveyed mooring location, where it is joined with other lengths of spine in a similar manner to that proposed for the inshore site. After this the mooring system is deployed.

The resulting length of spine has the advantage that, in a random sea, the spine intercepts many waves at different points between crest and trough. This randomises the magnitude and direction of wave loading applied to various parts of the spine and results in a low overall force. This, together with the highly compliant mooring scheme, helps to reduce the maximum loads experienced by the rodes.

The proposed assembly, tow out and installation method contains several aspects which would require extensive development to provide a workable scheme. These include:

- It is unlikely that the Duck could be easily joined to its spine section. A specially designed jig capable of rotating the spine section in the water would probably be required. Even then there would still be significant problems in ensuring alignment and connection of all the parts of the spine-Duck bearing.
- The tow to site would take the string sections through regions of strong tidal currents. This, together with the size of the string sections, would result in a low towing speed, which would increase the hazard of being caught in stormy weather.

#### 5.5.5 Summary of Technical Comments

There are a number of aspects of the 1998 Duck, which require significant R&D to prove the feasibility of the concept. However, the number and potential severity of the problem areas have been reduced significantly from the 1991 design.

Perhaps the most significant technical difficulty faced by the Duck is its sheer size. Fabricating the individual sections (especially the water tight sealing face) would present a significant civil engineering challenge. Joining each spine section to its Duck body or to other sections would pose a marine engineering problem comparable to (or even greater than) any faced in North Sea structures. The Edinburgh team recognise these challenges and acknowledge that further R&D is required to establish confidence in their approach.

Nevertheless, they have demonstrated with their work since 1992 that they can provide answers to difficult technical problems.

## 5.6 ECONOMIC ASSESSMENT OF THE 1998 DUCK

An independent analysis of the 1998 Duck was carried out using the same methodology adopted for the assessments of the 1983 and 1991 Duck (Thorpe, 1992).

### 5.6.1 Capital Cost

The capital costing for a 2 GW scheme (334 Ducks) off South Uist was estimated to be ~£2.4 B. This represents a cost reduction of 60% from the 1991 scheme. The areas in which these savings are predicted to be achieved are shown in Figure 5.11. However, it should be noted that these costs assume that all the potential problems identified in Section 5.5 are solved satisfactorily and without additional cost.

### 5.6.2 Operating and Maintenance Costs of the 1998 Duck

The adoption of a simpler M&E system, easier access for repair and a reduction in the number of critical components is predicted to decrease the annual O&M costs slightly to ~ £ 74 M.

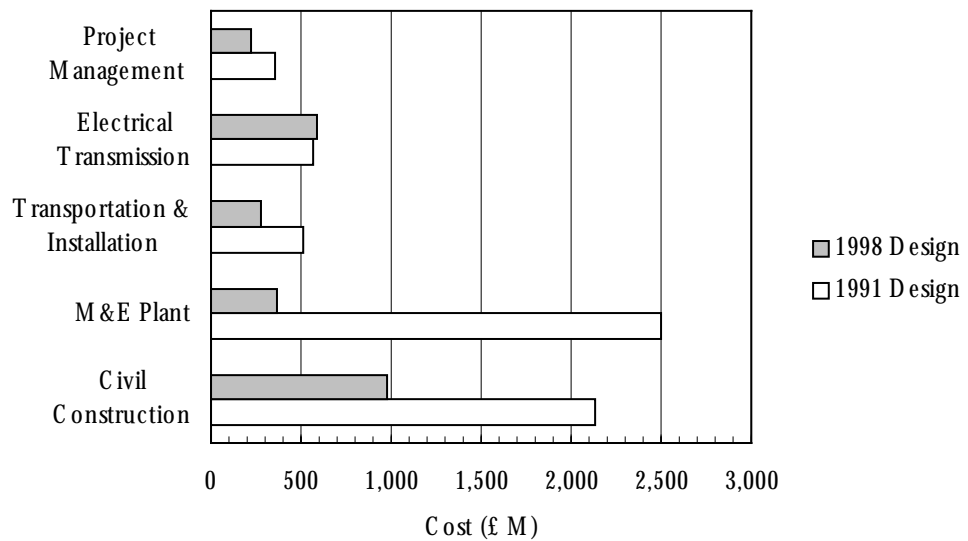
### 5.6.3 Electrical Output from the 1998 Duck

There are three main aspects to consider in determining the average annual output of a 2 GW Duck wave energy scheme:

- available wave power;
- capture efficiency of the Duck;
- efficiency of the power chain (hydraulics, generators, transmission line etc.).

These aspects will be considered separately in this Section.

**Figure 5.11 Effect of Changes on the Capital Cost of a Duck Scheme**



**Available Wave Power**

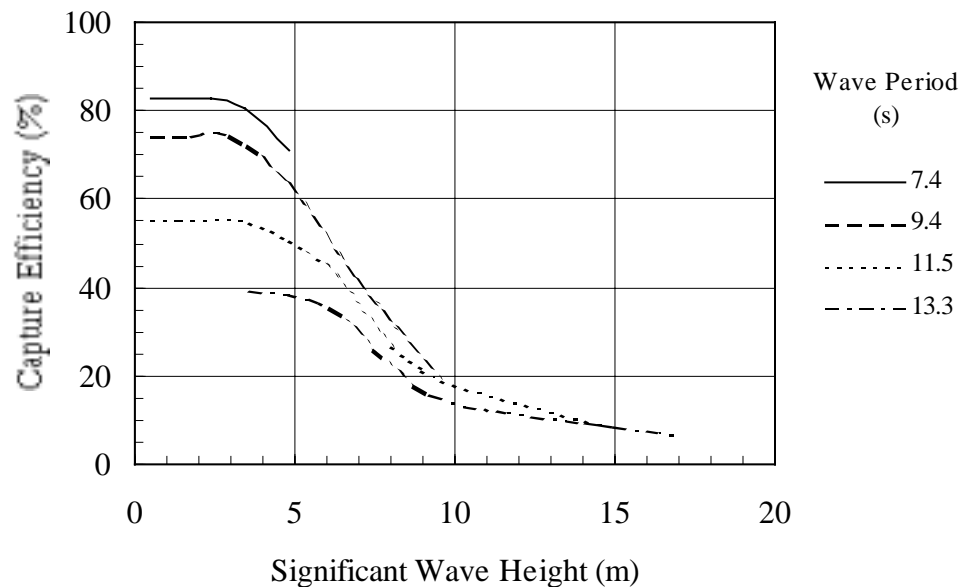
As outlined in Chapter 2, the wave power resource in 100 m water depth at South Uist has been theoretically determined (Whittaker *et al*, 1992) and characterised by a number of representative sea states as shown in Table 2.2. The average annual power in the sea predicted by these sea states is 71.6 kW/m. However, this power is distributed across waves travelling in all directions, whereas the Duck can capture power from only those waves travelling towards the front of the Duck. Therefore, the available wave power is reduced by the directionality factor, which was calculated to be 0.9 resulting in an effective wave power level at 100m water depth of 64.6 kW/m.

**Capture Efficiency of the Duck**

The capture efficiency was defined as the fraction of the wave power incident on the spine which was usefully absorbed. It was measured in tests in a narrow wave tank using computer generated random seas, which showed that the capture efficiency decreased with increasing of wave height and period (Figure 5.12). Given the complexity and inherent non-linearity of the device, there is some uncertainty concerning the applicability of these results to a string of full size Ducks.



**Figure 5.12 Capture Efficiency of the Duck**



In addition to the experimental efficiencies shown in Figure 5.12, the practical capture efficiency would be further limited by the rating of the M&E plant of the Duck. Increasing rating would allow more of the power in energetic sea states to be captured but this would require increasingly expensive M&E plant. For the 1991 Duck, the design team decided that the best compromise was to limit the Duck power capture to 63 kW/m. However, the 1998 Duck can handle power levels of more than 100 kW/m. The power limit and the capture efficiency relationships shown in Figure 5.12 were incorporated in a computerised spreadsheet together with the sea state data from Table 5.2. The average annual capture efficiency was calculated as:

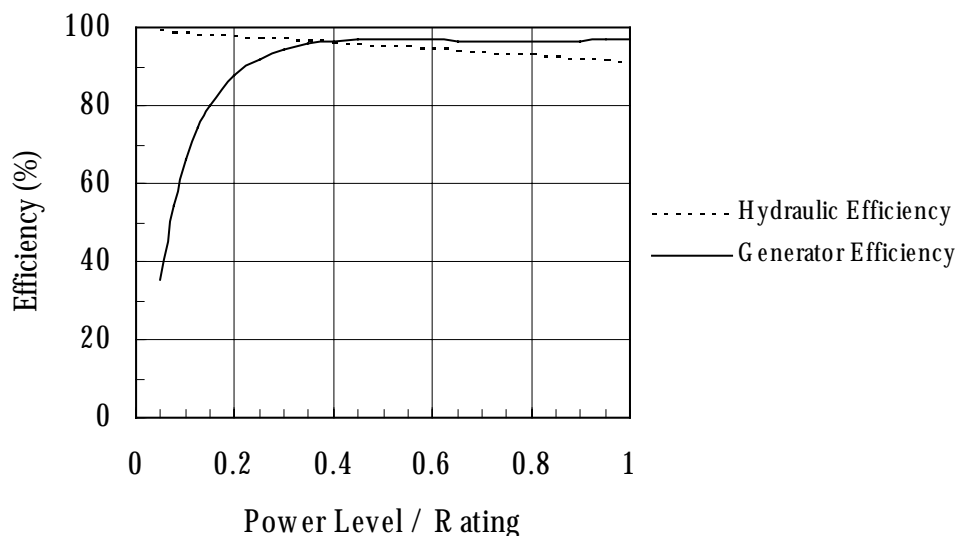
$$C_{ave} = \frac{\sum C_i \{H_s, T_e\} P_i W_i}{\sum P_i W_i} \tag{Eqn. 5.1}$$

The annual capture efficiency calculated by the above method was 50% (compared to 43% for the 1991 design).

**Power Chain Efficiency of the Duck**

The average annual efficiency of the various components of the power chain (i.e. the hydraulic system and generators) was calculated using an approach similar to that for the capture efficiency and the operating characteristics shown in Figure 5.13.

**Figure 5.13 Operating Characteristics of the Duck Power Chain**



The various parameters contributing to the determination of the overall power output of a single Duck spine section have been listed in Table 5.2 and compared to the equivalent values for the 1991 design.

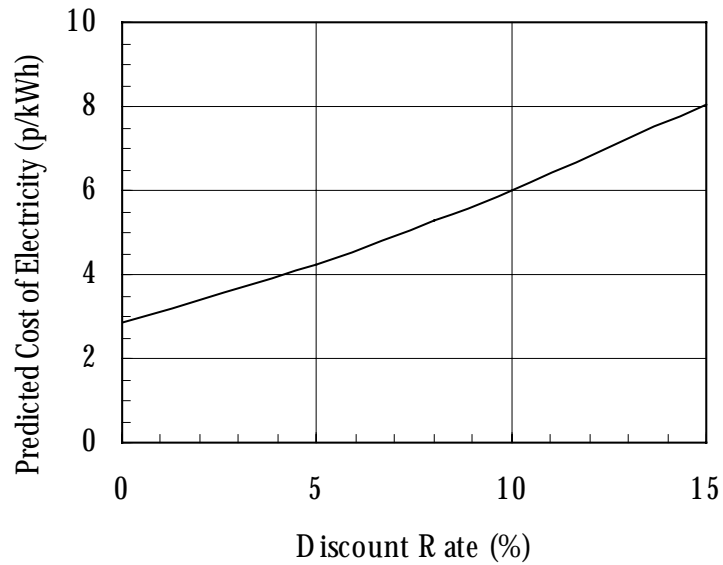
**5.6.4 Generating Costs for the 1998 Duck**

The improvements outlined in this Chapter were assimilated in a spreadsheet to calculate the generating costs of the 1998 Duck at a range of discount rates (Table 5.3). The results are plotted in Figure 5.14 and indicate costs of 5.3 p/kWh and 8 p/kWh at 8% and 15% discount rate respectively. This represents a reduction of nearly 70% from the values calculated for the 1991 Duck. For comparison, a 70% reduction in generating costs was achieved on moving from the 1983 to the 1991 design (Thorpe, 1992).

**Table 5.2 Operating Characteristics of the 1991 and 1998 Duck**

	<b>1998 Design</b>	<b>1991 Design</b>
Average Wave Power Level (kW/m)	72	72
Number of Ducks	334	864
Duck Separation (m)	62	45
Directionality Factor	0.9	0.9
Capture Efficiency (%)	50.3	43
Hydraulic Efficiency (%)	94.7	94
Generator Efficiency (%)	96.3	95
Average Output (MW)	615.96	1204
Availability	98	52.9
Annual Electrical Output (GWh)	5,288	5,578

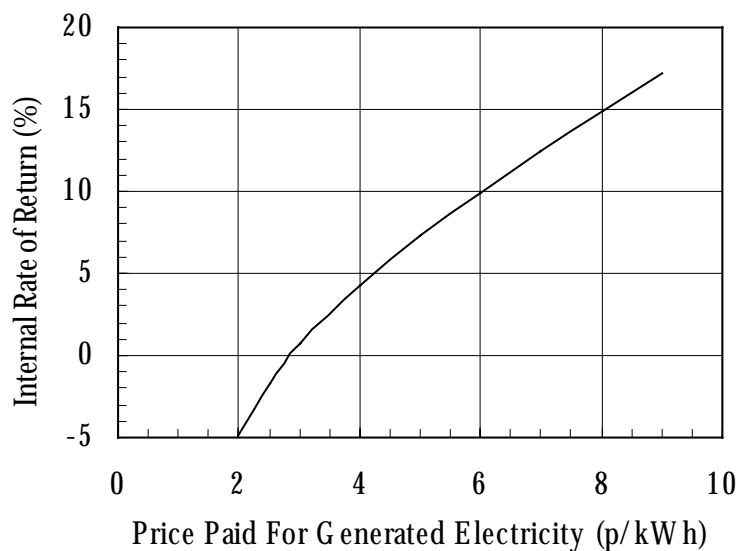
**Figure 5.14 Predicted Generating Costs of the 1998 Duck**



**5.6.5 Internal Rate of Return for the 1998 Duck**

The above information was used to calculate the internal rate of return for a 2 GW Duck scheme. The results are shown in Figure 5.15 and indicate that such a project would achieve a positive rate of return if it could sell its electricity for 3 p/kWh or more.

**Figure 5.15 Internal Rate of Return of the 1998 Duck**



**Table 5.2 Calculation of the Generating Costs of the 1998 Duck**

THE SCHEME		Year	Annual Output (GWh)	Discounted Output (GWh)	Annual Cost (£M)	Discounted Cost (£M)
		0			487.60	487.601
		1	1,057.58	979.24	487.60	451.48
		2	2,115.16	1,813.41	487.60	418.04
		3	3,172.74	2,518.62	487.60	387.07
Average Wave Power Level	72 kW/m	4	4,230.32	3,109.41	488.13	358.79
Number of Ducks	334	5	5,287.90	3,598.85	74.06	50.40
Device Width	62 m	6	5,287.90	3,332.27	74.06	46.67
Directionality Factor	0.9	7	5,287.90	3,085.44	74.06	43.21
Capture Efficiency	50 %	8	5,287.90	2,856.89	74.06	40.01
Hydraulic Efficiency	94.7 %	9	5,287.90	2,645.27	74.06	37.05
Generator Efficiency	96.3 %	10	5,287.90	2,449.32	74.06	34.30
		11	5,287.90	2,267.89	74.06	31.76
Average Output	616 MW	12	5,287.90	2,099.90	74.06	29.41
Availability	98 %	13	5,287.90	1,944.35	74.06	27.23
Annual Electrical Output	5,288 GWh	14	5,287.90	1,800.32	74.06	25.21
		15	5,287.90	1,666.97	74.06	23.35
		16	5,287.90	1,543.49	74.06	21.62
		17	5,287.90	1,429.15	74.06	20.02
		18	5,287.90	1,323.29	74.06	18.53
		19	5,287.90	1,225.27	74.06	17.16
		20	5,287.90	1,134.51	74.06	15.89
		21	5,287.90	1,050.47	74.06	14.71
Discount rate	8 %	22	5,287.90	972.66	74.06	13.62
Capital cost	7.3 £ M/device	23	5,287.90	900.61	74.06	12.61
Cost of spares	0.53 £ M/scheme	24	5,287.90	833.90	74.06	11.68
O&M rate	74 £ M/year	25	5,287.90	772.13	74.06	10.81
		26	5,287.90	714.93	74.06	10.01
		27	5,287.90	661.98	74.06	9.27
		28	5,287.90	612.94	74.06	8.58
		29	5,287.90	567.54	74.06	7.95
<b>Cost of electricity</b>	<b>5.27 p/kWh</b>	30	5,287.90	525.50	74.06	7.36
		31	4,230.32	389.26	59.25	5.45
		32	3,172.74	270.32	44.44	3.79
		33	2,115.16	166.86	29.62	2.34
		34	1,057.58	77.25	14.81	1.08

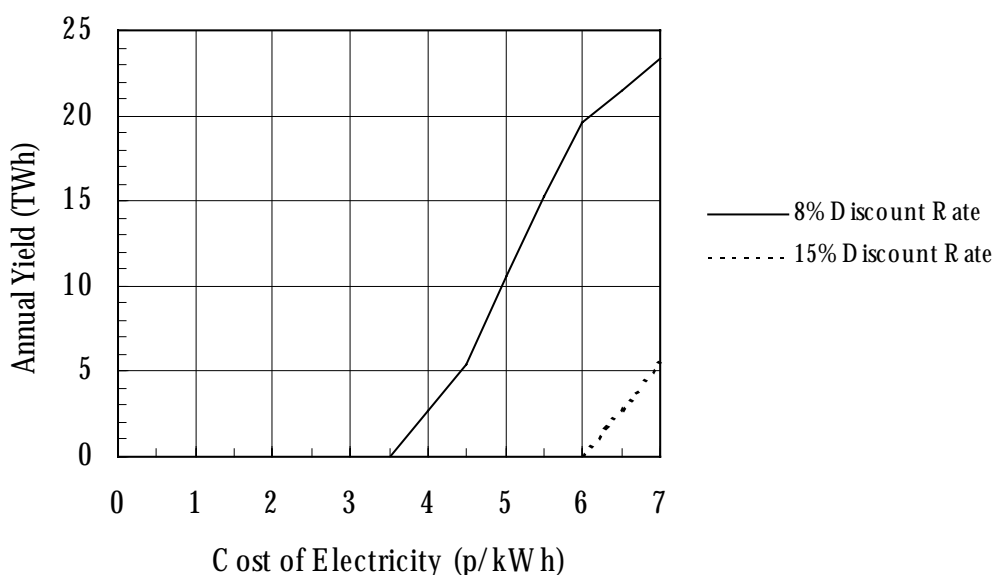
## 5.7 RESOURCE-COST CURVES FOR THE 1998 DUCK

Resource-cost curves have been derived for the 1998 Duck (using the methodology described above) by taking into account the variation in:

- Wave power level around the western side of the UK;
- Distance offshore corresponding to 100 m water depth;
- Distance from landfall to the HV grid.

The results are shown in Figure 5.16 for discount rates of 8% and 15%.

**Figure 5.16 Cost-Resource Curves for the 1998 Duck**



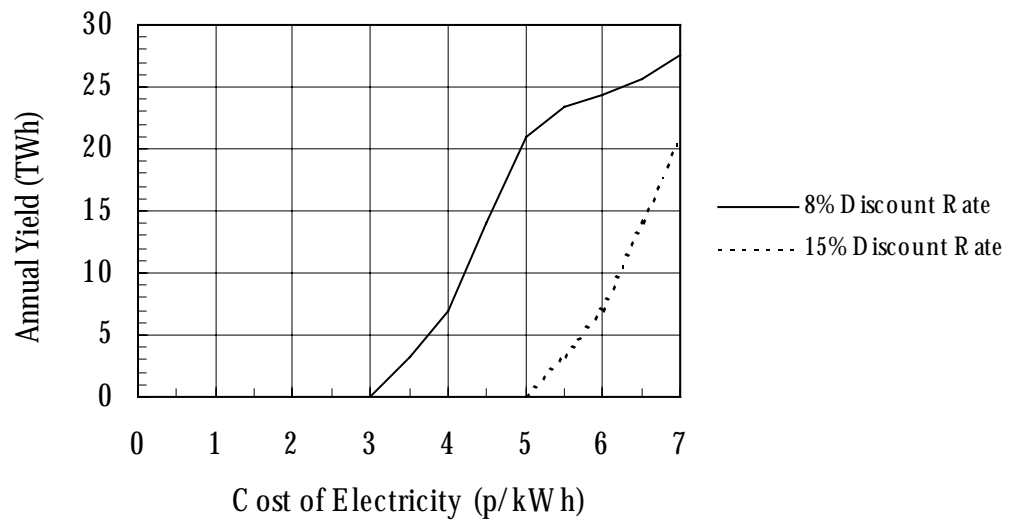
## 5.8 POTENTIAL COST REDUCTIONS

There are two main areas where further improvements are possible:

- **Capital costs.** The main cost centres are the civil structure costs and the mechanical and electrical plant. The structural costs could be reduced by using alternative construction techniques but this cannot be quantified. There is also scope for reduction in installation costs.
- **Capture efficiency.** The use of complex conjugate control could increase the capture efficiency from 50% to ~60% (if successfully implemented).

The effect of such changes has been calculated and the resulting resource-cost curves are shown in Figure 5.17.

**Figure 5.17 Cost-Resource Curves for the Duck with Enhanced Capture**





## 6 New Devices

In recent years, considerable attention has been given new modular devices, which are capable of extracting energy from a wavefront wider than their physical dimensions. In order to assess what could be a promising direction in wave energy, three representative devices will be considered:

- PS Frog;
- McCabe Wave Pump;
- Sloped IPS Buoy.

### 6.1 THE PS FROG

#### 6.1.1 Background

Work at Lancaster University on the engineering design of a new device (the Frog) began in 1985 (Lancaster University, 1986). This developed into a study of the engineering of this device moving in combined pitch and surge (PS Frog - referred to as Frog hereafter), which led to a preliminary costing and evaluation of the output from such a scheme (Lancaster University, 1988). Subsequently, work has progressed on optimising the design of the device (French, 1991), understanding the device hydrodynamics (Bracewell, 1990) and determining the most efficient configuration (Folley, 1991).

The device was assessed as part of the UK wave energy review (Thorpe, 1992), which found it to be at a relatively early stage of development but, nevertheless, it appeared to be one of the more promising devices.

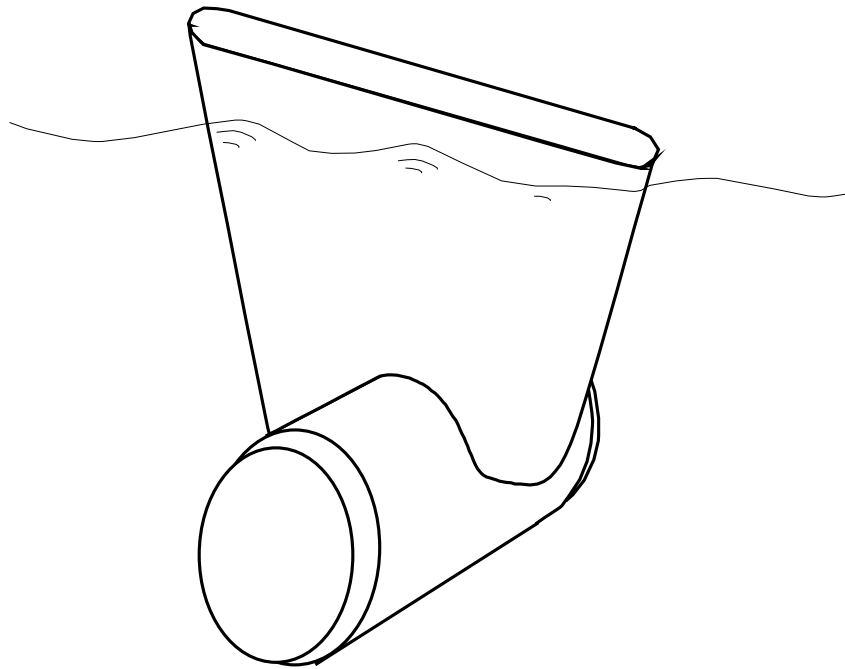
Since then, further work has been carried out on refining the device and improving its economics.

#### 6.1.2 Outline of the PS Frog

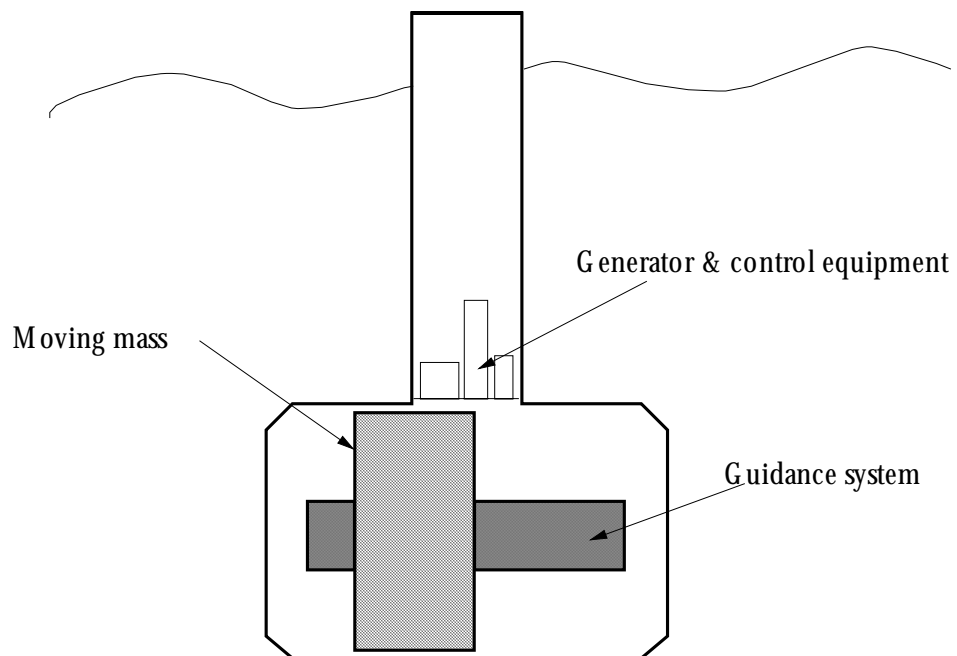
The original Frog had a paddle-shaped upper part attached to a cylindrical lower part (Figure 6.1). The upper part forms the working surface, whilst the lower part contains all the mechanical and electrical plant including a large reaction mass, which moves with respect to the hull. Without this mass, the device would move passively in the waves and no power could be extracted. Hydraulic rams make the mass move and enables energy to be extracted via high pressure oil. This oil feeds an accumulator (to smooth out power fluctuations) and thence a hydraulic motor and electrical generator. Electricity is transmitted to shore via flexible, subsea cables.



**Figure 6.1 Outline of the First Version of PS Frog**



**General View**



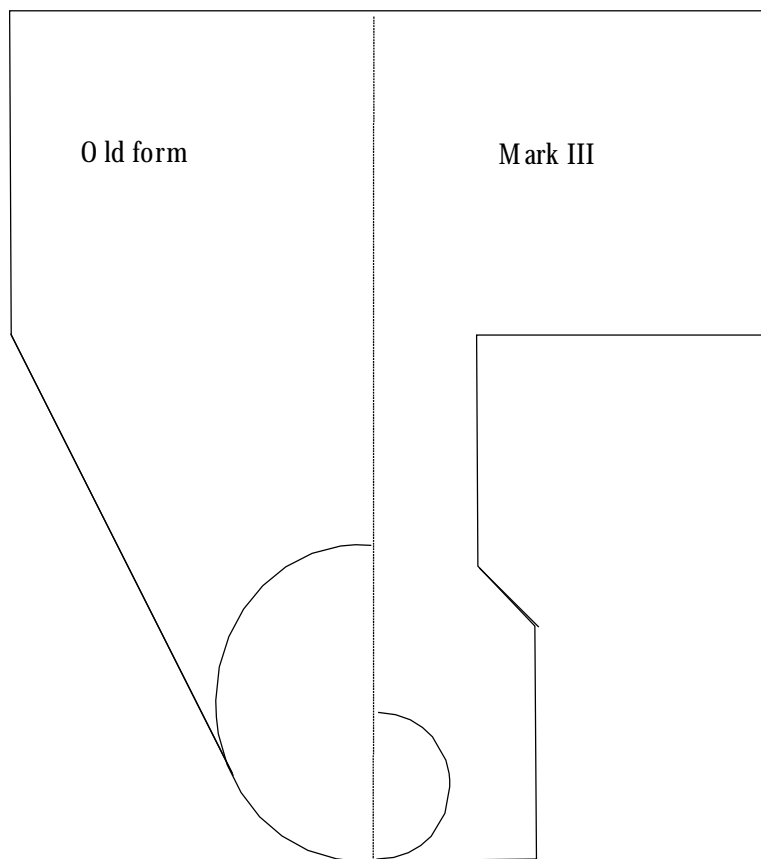
**Schematic View**

The new design (Mark III) has a modified shape in which the former large paddle has been replaced by a shallower one (Figure 6.2) some 21 m wide facing the oncoming waves. This shape reduces the radiation coefficient but increases the effective amplitude at the centre of pressure, thereby allowing a smaller sliding mass to be used.

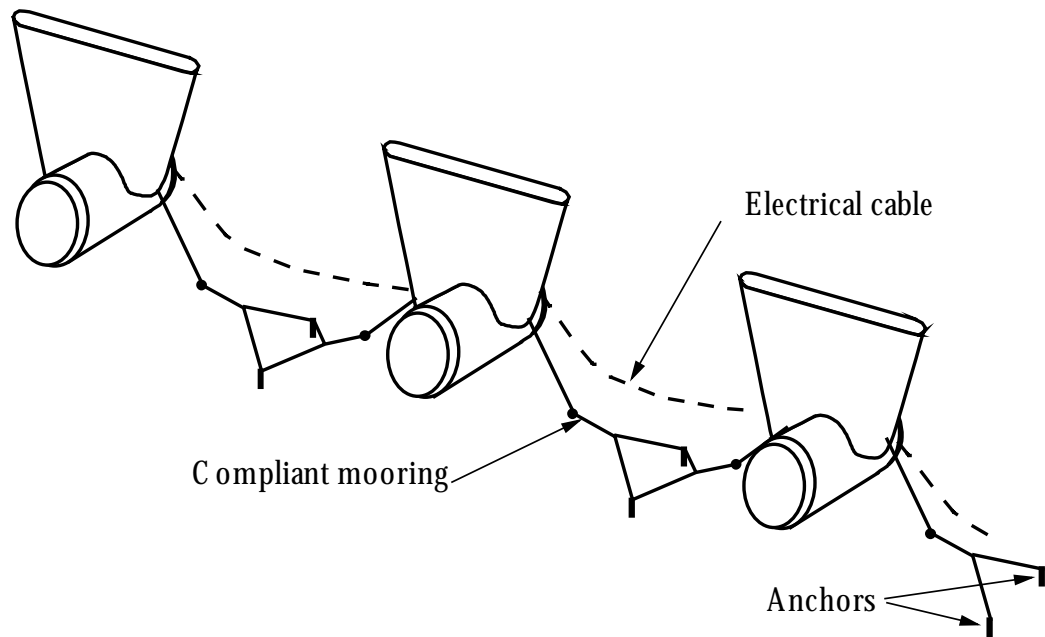
The Mark III Frog consists of a floating, 12 mm thick welded steel hull (24 mm near the bottom), which contains all the M&E plant. The smaller reaction mass has allowed a redesign to reduce the overall weight of the steel structure by 50% to 110 t and the displacement from 1625t to 1300 t.

The device is connected to the sea bed by compliant moorings. These allow sufficiently large movements in heavy seas to avoid damage. It can be moored in a wide range of water depths but 40 m is thought to be optimum. The output from a linear array of devices can be gathered together for transmission to shore (Figure 6.3).

**Figure 6.2 Comparison of the Old and Mark III PS Frog**



**Figure 6.3 An Array of the Old PS Frogs**



### Operation of the Device

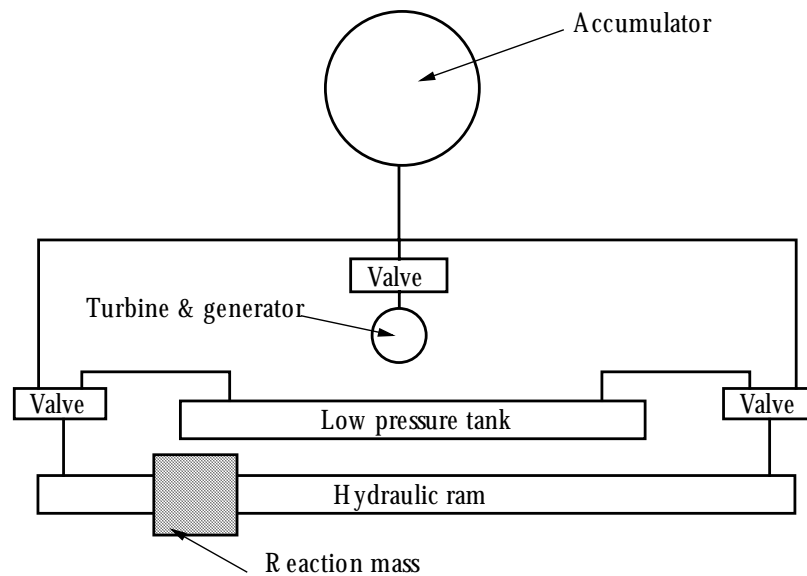
As the device moves in a combination of pitch and surge, a 400 t reaction mass tries to slide back and forth along guide rails (Figure 6.4). However, this sliding is controlled by hydraulic rams on either side of the mass, which can operate in one of three ways:

- Shut off to hold the ram still;
- Connect to a high pressure oil system, so they act as pumps to charge up the system;
- Connect to a low pressure oil system, so they offer little resistance to the movement of the mass.

Switching between these three states allows a refined level of control over the movement of the mass and hence the response of the device. It can keep the Frog in a state of quasi-resonance, in which the hull moves vigorously, with the correct phase relationship to the sea in order to extract the maximum energy. The high pressure oil is fed into a large hydraulic accumulator to provide some energy storage before being used to drive an hydraulic motor and generator.

### Summary

The device is an elegant theoretical concept, which has yet to undergo detailed design and analysis. Therefore, its productivity and costs are subject to

**Figure 6.4 Outline of Part of the Frog's Hydraulic System**

considerable uncertainty (e.g. it is thought likely that greater strength will be required in the parts of the structure around the joint between the “Bat” and the power canister in order to avoid fatigue failure). Nevertheless, there appears to be no insuperable difficulties in developing a viable device.

### 6.1.3 Economic Assessment of the PS Frog

#### **Available Wave Power**

The wave power resource at a 40 m water depth near South Uist is  $\sim 52$  kW/m and the representative sea states are listed in Table 6.1 (Whittaker *et al*, 1992b). However, not all of these waves come from the same direction. A directionality factor of  $\sim 0.94$  has been calculated to account for this.

#### **Capture Efficiency of the PS Frog**

The behaviour of the device has been evaluated theoretically using a large computer programme (Bracewell, 1990) and more recently in work by French (1998). This predicted an average annual capture efficiency of about 66% for random seas with a spectrum similar to that shown in Table 6.1. Wave tank testing is currently underway to investigate the accuracy of these predictions. Therefore, in the absence of data relating capture efficiency to  $H_s$  and  $T_e$ , an average capture efficiency of 66% has been adopted. This is probably the major source of uncertainty in the analysis and the assessment should be reviewed following successful wave tank testing.

**Table 6.1 Representative Sea States for 40 m Water Depth**

Significant Wave Height, Hs (m)	Wave Energy Period, Te(s)	Wave Power Level, Pi (kW/m)	Weighting of Sea State, Wi (%)
1.7	5.9	8.4	0.48
1.4	7.2	7.1	3.17
1.7	9.4	13.4	1.78
1.9	10.8	19.2	0.5
2.3	12.4	32.3	0.16
3.2	7.5	37.8	0.88
3	8.5	36.9	1.88
2.8	10.4	40.1	1.07
2.9	14.1	58.3	0.15
4.4	9	85.7	0.81
3.9	10.8	80.8	2.25
4.1	12.5	103.4	1.2
6.4	11.7	235.8	0.52
6.6	14.4	308.6	0.21
1.9	6	10.7	1.33
1.5	7.3	7.8	3.9
2	9	17.7	4.06
1.6	12.5	15.7	1.82
3.3	7.4	39.6	0.97
3	8.5	37.4	3.7
2.7	11.8	42.3	3.04
3.1	12.8	60.5	0.43
4.6	9	93.7	1.13
4.5	10.4	103.6	2.98
3.3	12.2	65.4	3.14
4.4	14.4	137.2	1.3
4.7	9.5	103.2	0.95
10.1	14.5	727.7	0.27
11.2	17.1	1055.4	0.09
2	5.9	11.6	1.16
1.8	7.1	11.2	4.43
1.9	8.9	15.8	7.08
1.8	11.9	19	3.14
1.7	14.1	20	0.36
3.2	7.4	37.3	1.33
3	9.2	40.9	3.19
2.8	12.2	47.1	2.37
3.4	14.1	80.2	0.41
4.3	9.3	84.6	1.24
4.4	10.5	100	2.99
4.3	13.7	124.6	3.1
5.3	16.6	229.4	0.6
6.7	10.7	236.3	0.72
8.4	12.9	447.8	0.32
9.4	16.1	699.9	0.18
12.4	19.2	1452.5	0.03
1.8	5.8	9.2	1.24
1.3	7.3	5.7	5.25
1.4	9.3	9	4.72
1.1	11.3	6.7	1.34
2.6	7.3	24.3	0.65
3	8.3	37.1	2.36
3.4	9.3	52.9	1.11
2.7	14.2	50.9	0.14
4	8.5	66.9	0.3
3.8	11.4	81	0.7
3.6	10.7	68.2	1.21
4.2	12	104.1	0.84

5.3	10	138.2	0.34
6.6	11.5	246.5	0.37
7	12.3	296.5	0.31
8.7	18	670.3	0.06

---

### **Efficiency of the Power Chain**

The losses in the hydraulic pumps, piping, accumulators and turbines can be calculated theoretically using standard equations. A preliminary analysis of this by the Lancaster team indicates an efficiency of ~ 92%. This value was close to the independent calculations undertaken as part of this review and so was adopted.

The efficiency of the electrical system (e.g. generator and transformer) were estimated to be ~ 89%.

### **Availability of the PS Frog**

The design team have estimated the availability of the scheme as 94%. An independent analysis undertaken as part of this review predicted an availability of 93% due to repairs and maintenance.

### **Annual Output from the PS Frog**

The results of the above analyses have been summarised in Table 6.2. This would indicate an average output of 529 kW per device.

**Table 6.2 Summary of the Productivity Analysis of PS Frog**

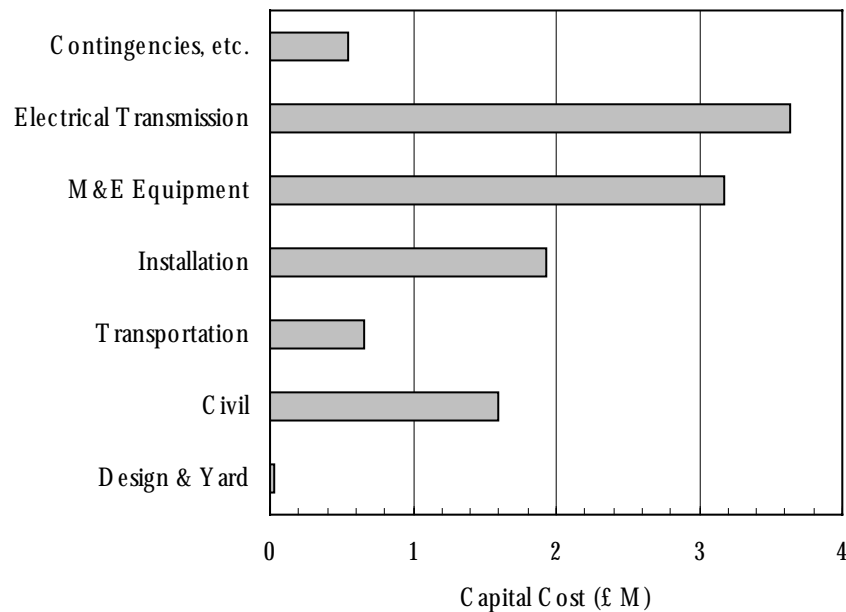
Power in Sea	50 kW/m
Device Width	21 m
Directionality	0.94
Mean Power Intercepted	987 kW
Capture Efficiency	66 %
Power Captured	651 kW
Conversion Efficiency	92 %
Electrical Efficiency	88 %
Availability	93 %
Average Power Output	529 kW
Annual Output	4.3 GWh

### **Costs of the PS Frog Scheme**

An assessment of a PS Frog wave power scheme consisting of 10 devices was made.

#### ***Capital Costs***

This parametric costing model predicted a total capital cost (including contingencies and project management fees) of ~ £ 1.1 M per device. A breakdown of these costs is shown in Figure 6.5.

**Figure 6.5 Breakdown of Capital Costs for a 10 PS Frog Wave Energy Scheme****O&M Costs**

An estimate of the annual O&M rate was based on the above evaluation of availability and component costs. This predicted an annual cost of £ 44,000 per device. In addition there would be a one-off cost for spares of £ 21,000 per device.

**Cost of Electricity Generation from the PS Frog**

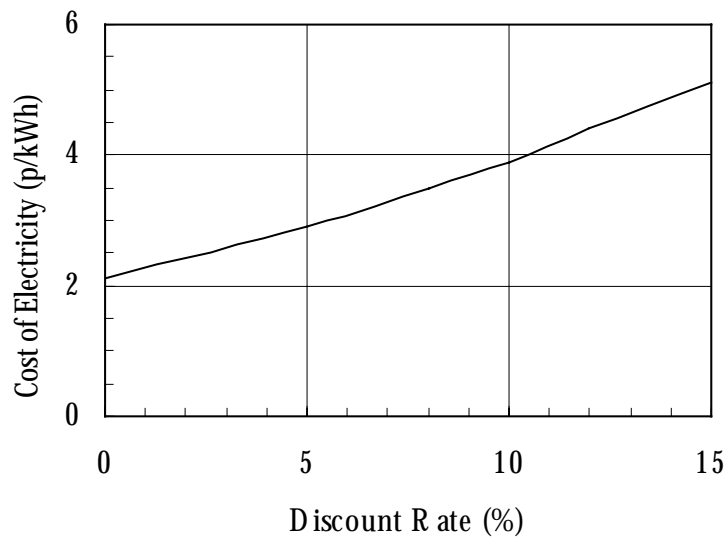
The costs of electricity generation at various discount rates have been calculated and the results have been plotted in Figure 6.6. The transmission costs form the major cost centre, because of the long distances between the device location and the main grid. The relative proportion of these costs could be reduced by :

- moving to another location but this would also affect the device output, because of the different wave regime.
- adopting a larger scheme with more devices, where the transmission costs would be defrayed over a greater output.

Therefore, these generating costs should be taken as indicative; the costs could be lower if the deployment location were optimised. In addition, the future generating costs might be further reduced by a modification currently being evaluated by the Lancaster team. This promises to increase the capture efficiency at little extra cost. However, more work is required to confirm this improvements.



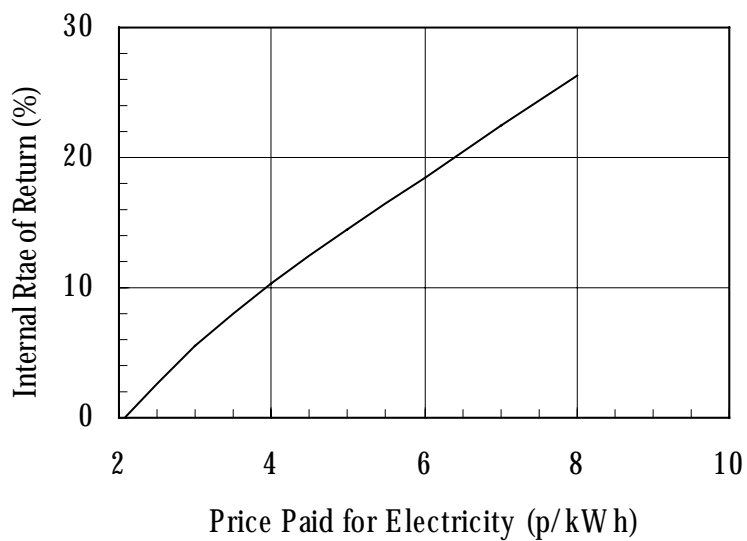
**Figure 6.6 Effect of Discount Rate on Generating Costs of PS Frog**



**Internal Rate of Return**

The internal rate of return was calculated for this particular scheme. The results (Figure 6.7) show that a positive rate of return is achieved if the price paid for electricity is greater than ~ 2 p/kWh.

**Figure 6.7 Internal Rate of Return on PS Frog Scheme**



## 6.2 THE MCCABE WAVE PUMP

### 6.2.1 Description of the Device

The device was conceived by Peter McCabe in 1980, after which it was studied both theoretically (McCormick *et al*, 1998) and experimentally (McCormick and Murtagh, 1992). In August 1996, a 40 m long prototype was deployed off the coast of Kilbaha, County Clare, Ireland and a new demonstration device is currently being constructed.

The device consists of three rectangular steel pontoons (Figure 6.8), which are hinged together across their beam. These pontoons are aligned so that their longitudinal direction heads into the incoming waves. The bow of the fore pontoon is slack-moored and two more slack moorings are attached part way down the aft pontoon (Figure 6.9). This allows the system to vary its alignment in order to head into the oncoming seas.

The three pontoons move relative to each other in the waves. The essential aspect of the scheme is the damper plate attached to the central pontoon; this increases the inertia of the central pontoon (by effectively adding mass), ensuring that it stays relative still. Therefore, the fore and aft pontoons move relative to the central pontoon by pitching about the hinges. Energy is extracted from the rotation about the hinge points by linear hydraulic rams mounted between the central and two outer pontoons near the hinges. Control of the characteristics of the hydraulic system allows the device to be tuned to the prevailing sea state and so optimise energy capture.

The designer intended this device to pressurise sea water for use in a reverse osmosis system to produce potable water. Independent analysis of the MWP has shown that it would be economically competitive in such a market. This review will evaluate the use of the high pressure oil produced by the rams to drive an hydraulic motor attached to an electrical generator. This will require the use of an accumulator to absorb any power fluctuations and so smooth the output of the system.

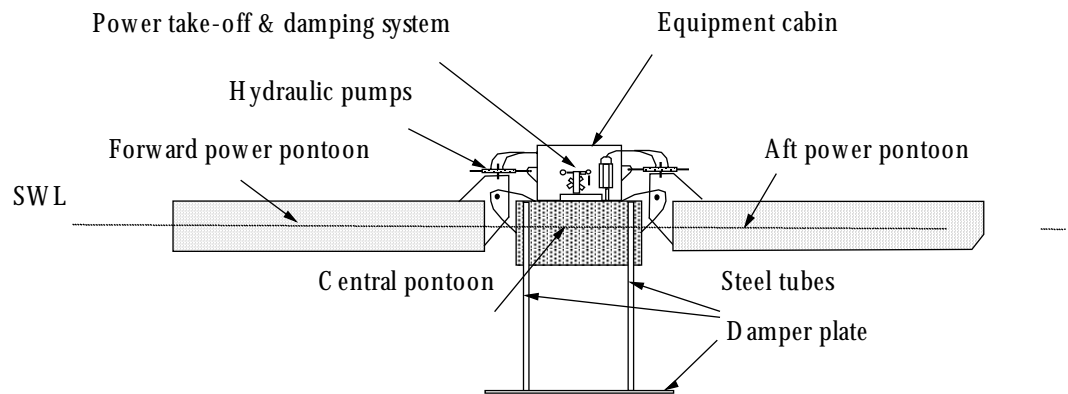
### 6.2.2 Economic Assessment of the MWP

#### Capture Efficiency

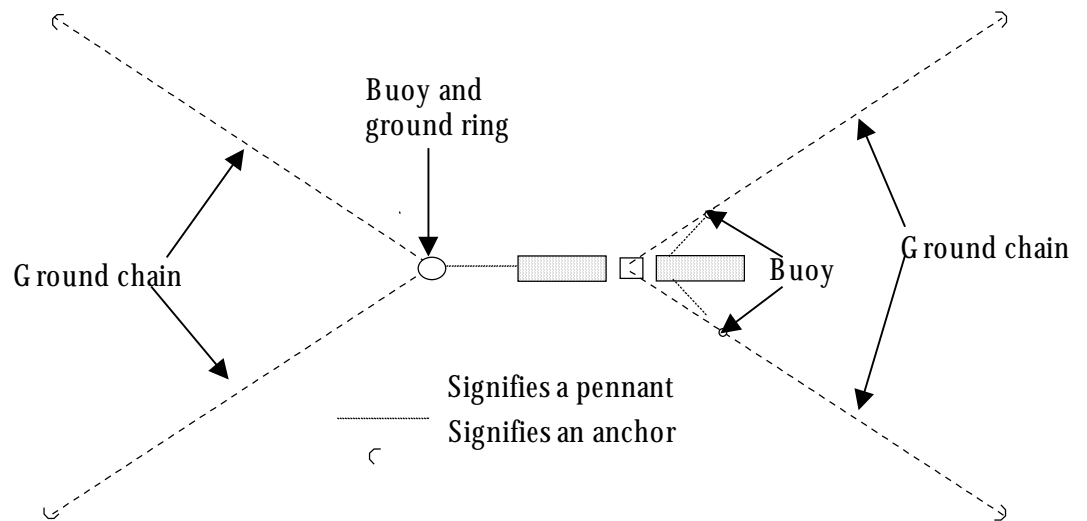
There are some experimental data from small-scale tests, together with a short period of observations on the prototype. These indicate that the MWP can have capture efficiencies >100%.

In order to evaluate the performance of the MWP in a range of sea states, its behaviour has to be evaluated theoretically. In a recent paper, McCormick, McCabe and Kraemer (1998) conducted a linear analysis of a critically damped MWP. That approach has been used as the basis of the following analysis.

**Figure 6.8 Outline of the McCabe Wave Pump**



**Figure 6.9 Mooring Arrangement for the McCabe Wave Pump**



Under the influence of wave motion, the device behaviour with respect to time (t) is predicted by the type of differential equation usually associated with damped vibrating systems:

$$I \frac{d^2 \theta}{dt^2} + R \frac{d\theta}{dt} + N \theta = M_o \cos(\alpha\{T\} + \Omega t) \quad \text{Eqn. 6.1}$$

where I is the moment of inertia, R is the damping factor,  $M_o$  the wave-induced moment amplitude,  $\alpha(T)$  the phase angle (dependent on the wave period, T) and  $\Omega$  the effective wave frequency (the other symbols are system dependent constants and curly brackets {} denote dependence of a variable on the expression inside them).

The moment of inertia of a pontoon of length L about the hinges is given by:

$$I = I_o + m_w \{T\} \frac{L^2}{4} \quad \text{Eqn. 6.2}$$

where  $m_w$  is the added mass of water, which is given by:

$$m_w = \frac{8\rho LW}{\pi k^2 (L^2 - W^2)} \left| W \left[ 1 - \frac{\pi M \{kW\}}{2kW} \right] - L \left[ 1 - \frac{\pi M \{kL\}}{2kL} \right] \right| \quad \text{Eqn. 6.3}$$

where  $M\{\}$  is a Sturve function, W is the width of the pontoon, k is the wave number ( $2\pi/\lambda$ ) and  $\rho$  is the density of sea water.

In a critically damped system, the damping due to energy extraction greatly exceeds that due to viscous and radiation damping. In this case, R is given by:

$$R \{T\} = 2 \sqrt{\left[ I_o + m_w \{T\} \frac{L^2}{4} \right] \left[ \rho g W \frac{L^3}{3} \right]} \quad \text{Eqn. 6.4}$$

where g is the acceleration due to gravity.

The amplitude of the wave-induced moment can be evaluated as:

$$M_o \{T\} = \frac{\rho g W H}{2k^2} (1 + e^{-kd}) C \quad \text{Eqn. 6.5}$$

where H is the incident wave height, d is the draft of the barge and C is given by strip theory as:

$$C = \sqrt{2 + (kL)^2 - 2 \cos(kL) - 2kL \sin(kL)} \quad \text{Eqn. 6.6}$$

Using strip theory, McCormick and Kraemer calculate this to be:

$$\alpha\{T\} = \tan^{-1} \left[ \frac{\sin(kL) - kL \sin(kl)}{\cos(kL) + kL \sin(kl) - 1} \right] \quad \text{Eqn. 6.7}$$

Using the above expressions, the solution to Equation 6.1 can be evaluated for the critically damped condition as:

$$\theta_{cr} = \left( \frac{3HC(1 + e^{-kd})}{2k^2 L^3 (1 + T_n^2/T^2)} \right) \cos(\alpha - \beta - \Omega t) \quad \text{Eqn. 6.8}$$

where  $T_n$  is the undamped natural period of the pitching motion, given by:

$$T_n = 2\pi \sqrt{\frac{I_o + m_w \{T\} \frac{L^2}{4}}{\rho g W \frac{L^3}{3}}} \quad \text{Eqn. 6.9}$$

and  $\beta$  (the angle between the wave-induced moment and the critically-damped pontoon movement) is given by:

$$\beta = \tan^{-1} \left( \frac{2T_n/T}{1 - T_n^2/T} \right) \quad \text{Eqn. 6.10}$$

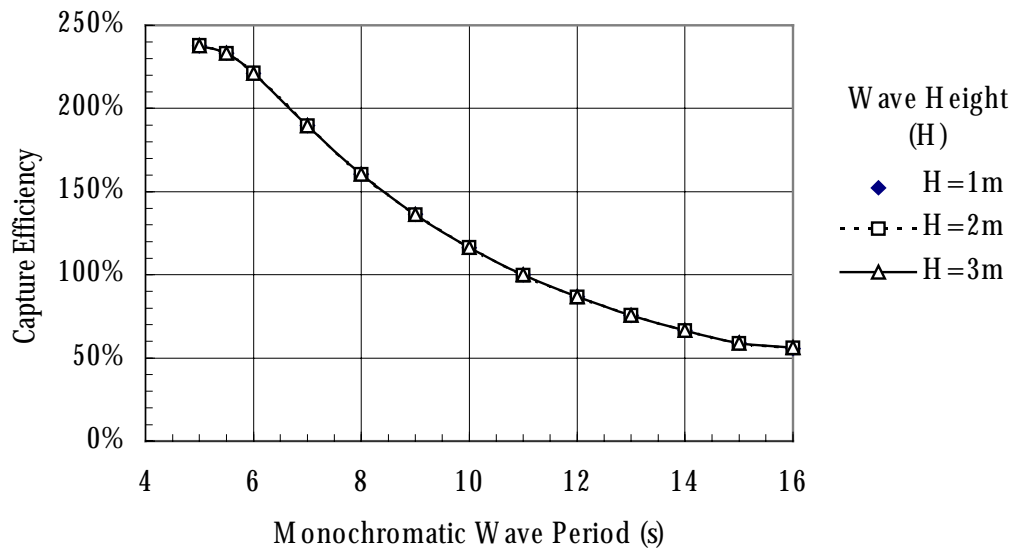
The average power ( $P_{ave}$ ) absorbed by the hydraulic system over one wave period is given by:

$$P_{ave} = \frac{4}{T} R_{cr} \left( \frac{L^2}{4} \right)^{T/4} \int_0^{T/4} \left( \frac{d\theta_{cr}}{dt} \right) dt \quad \text{Eqn. 6.11}$$

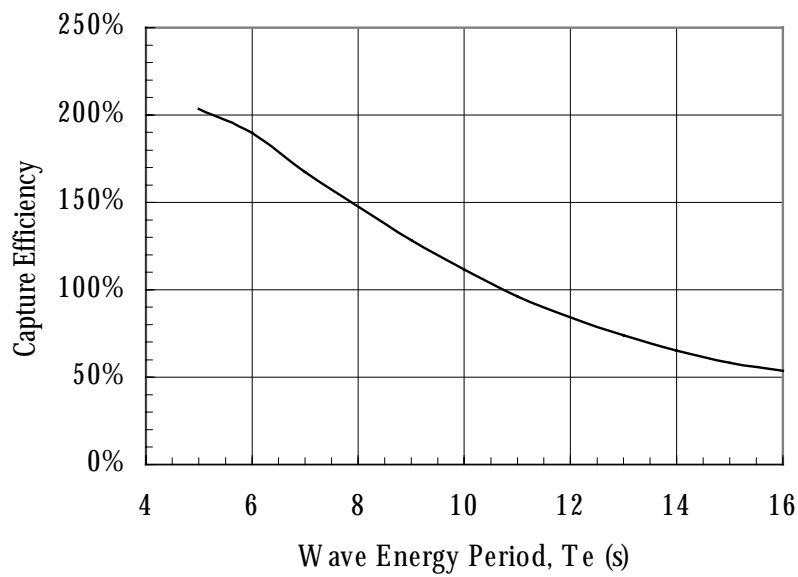
The above computations were carried out as part of this review for a range of incident regular (i.e. monochromatic) waves of different periods and heights. If the power captured is normalised by the wave power level, it can be seen that the efficiency is invariant with wave height and depends only on the wave period (Figure 6.10).

The above analysis is applicable to a device operating only in a regular, monochromatic sea. The above capture efficiency was applied to Pierson and Moskowitz seas (1964) with different wave energy periods ( $T_p$ ) and the resulting capture efficiency is shown in Figure 6.11. This shows a slight reduction in capture efficiency at short wave periods, when compared to the capture efficiency in regular seas.

### Figure 6.10 Predicted Capture Efficiency of the MWP in Regular Waves



**Figure 6.11 Predicted Capture Efficiency of an MWP in Real Seas**



The above predictions apply only to the fore pontoon. However, the aft pontoon will also capture wave energy. It is difficult to determine this theoretically but observations made on the prototype suggest that the aft pontoon picks up ~60% of the energy captured by the fore pontoon. This suggestion is in accordance with that indicated by McCormick *et al* (1998).

This capture efficiency was applied to the same sea states used in assessing the Frog (Table 6.1). The average capture efficiency was approximately 150%.

### Efficiency of the Power Chain

Conversion of the captured energy into electricity would involve losses the various parts of the power chain as indicated in Table 6.3. This assumes a high efficiency hydraulic motor, such as that developed by Edinburgh University for their design for a wave energy device (Salter and Rampen, 1993).

### Availability

The overall availability was calculated as part of this review to be 90% , allowing for repairs and planned maintenance.

### Output of the MWP

The above estimates have been summarised in Table 6.3, which indicates that the average annual output for an MWP is 2.25 GWh.

**Table 6.3 Summary of the Characteristics of the MWP**

Device Width	4 m
Sea Power Level	53 kW/m
Capture Efficiency	150 %
Hydraulic efficiency	98 %
Efficiency of hydraulic motor	95 %
Efficiency of generator	96 %
Availability	90 %
Average Output per Device	257 kW
Annual output of scheme	2.25 GWh

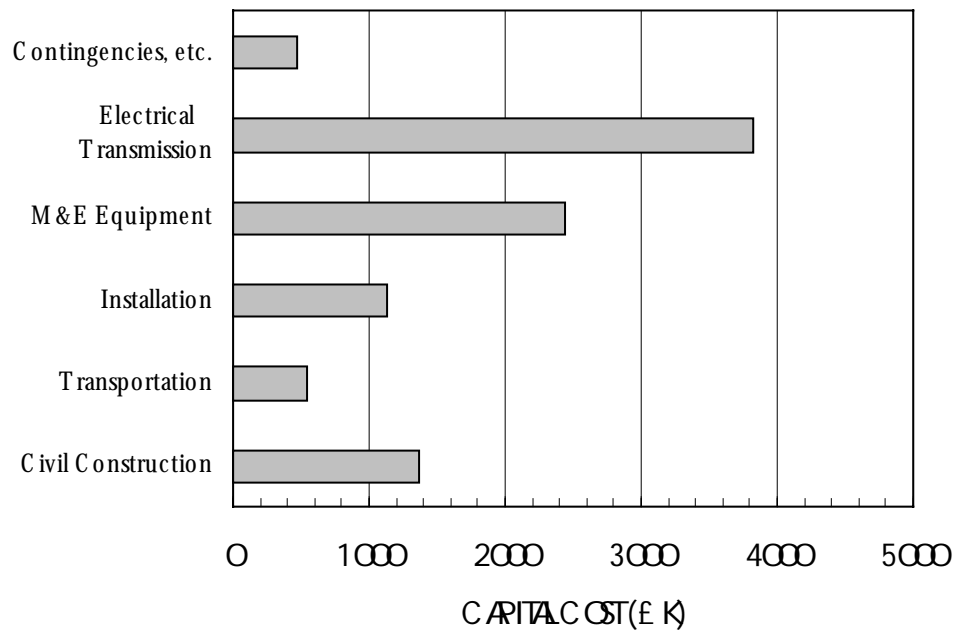
### Capital Costs of the MWP

An independent assessment of the capital costs of the MWP was undertaken assuming that the device would be deployed as a small-scale scheme of 10 units. The predicted cost was just over £ 1,000,000 per device with a cost breakdown as shown in Figure 6.12.

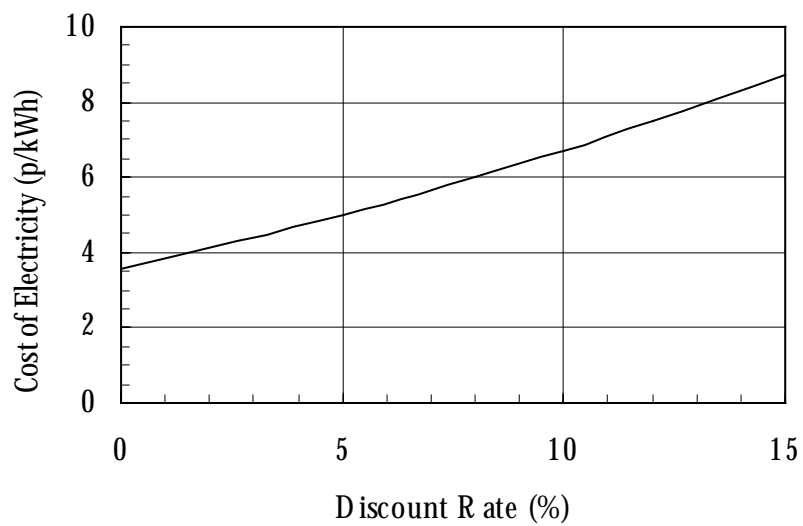
### O&M Costs

An estimate of the annual O&M rate was based on the above estimates of availability and component costs. This predicted an annual cost of ~ £ 30,000 per device. In addition there would be a one-off cost for spares of £ 15,000 per device.

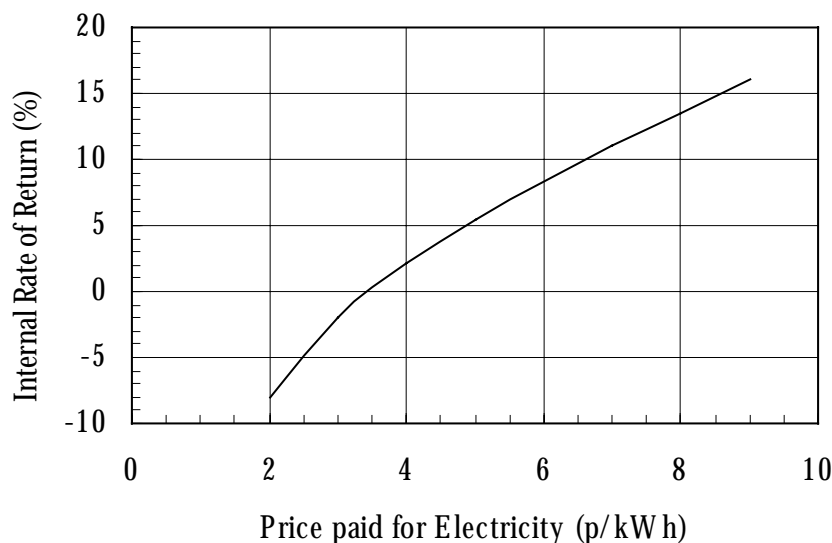
**Figure 6.12 Breakdown of Capital Cost of an MWP Scheme**



**Figure 6.13 Effect of Discount Rate on Generating Costs of MWP**





**Figure 6.14 Internal Rate of Return on an MWP Scheme**

### 6.3 THE SLOPED IPS BUOY

The sloped IPS buoy concept was developed by Edinburgh University as a device that would replace the Solo Duck as a confidence building step in wave energy technology (Salter and Lin, 1995). It is based on the axisymmetrical device designed by Interproject Services (IPS).

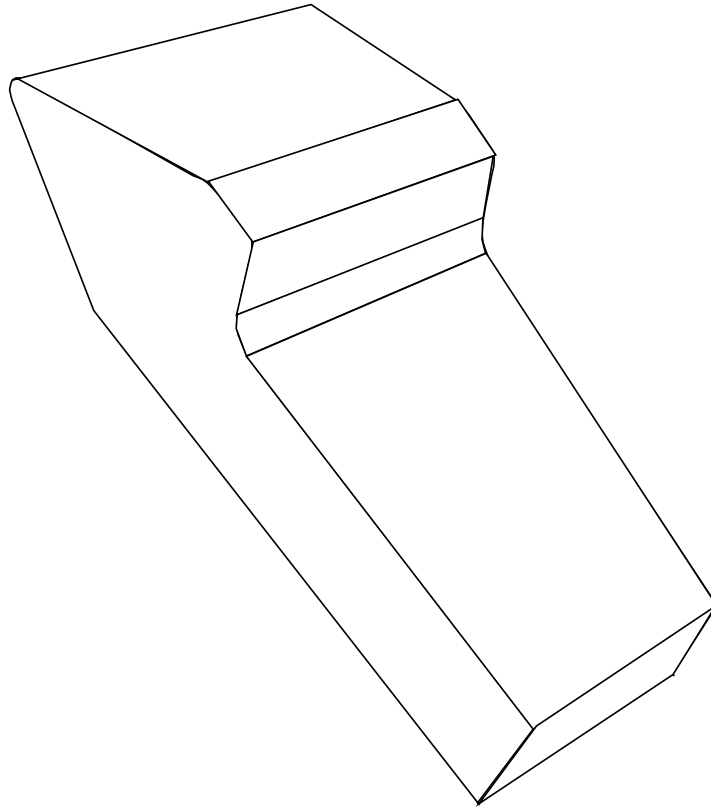
#### 6.3.1 Description of the Device

The device is an inclined flat plate with a curved head (approximately 30 m wide and 6 m from front to back), which is inclined at an angle to the vertical (Figure 6.15). The long tail is open to the sea at the bottom and is mainly empty (Figure 6.16), except for bracing plates. This adds a large inertia to movement in all directions, except for “slope” (i.e. back and forth in the direction of the tail). In this mode, the plates are edge on to the movement and so offer minimal resistance.

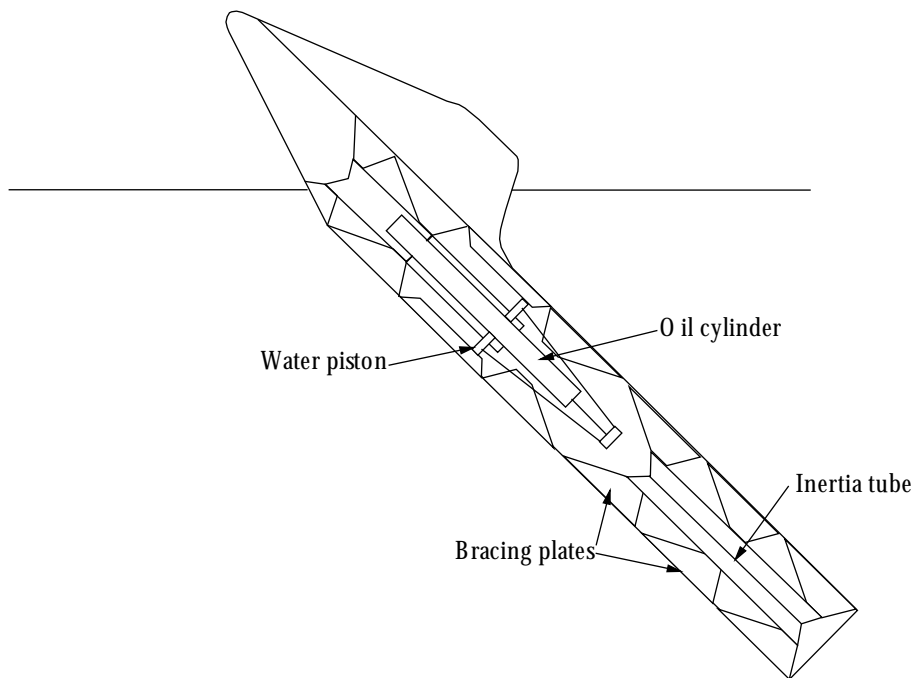
Within the body of the device, there is a restriction, in which is placed a water piston attached to a double acting hydraulic ram. The geometry is such that as the device moves in slope, the water piston (and hence the ram) remains nearly at rest. Work can be done by the ram in exploiting the relative motion between it and the structure to pump hydraulic oil to a motor, which powers a generator.

The “wedding cake” hydraulic motor (Salter and Rampen, 1993) has been proposed, in conjunction with an accumulator to provide short-term power smoothing. The piston will be operating in sea water and so will have to be suitably coated (“Ceremax” has been proposed), whilst the bearings would require special attention.

#### **Figure 6.15 Shape of the Sloped IPS Buoy**



**Figure 6.16 Side View of the Sloped IPS Buoy**



Power take-off would utilise a flexible cable passing through a sinker and floater arrangement similar to that for the Duck. In this way, the cable can accommodate the movements of the buoy without significant loading.

An important feature of the buoy is the flared ends of the tube containing the water piston. When the movement of the piston exceeds the length of the narrower part of the tube, it will enter the wider section allowing water to flow past it more easily. This flow effectively decouples the piston from the large inertia of the water mass in the tail. This arrangement avoids the shock loading that “end stops” can cause.

### 6.3.2 Economic Assessment of the Sloped IPS Buoy

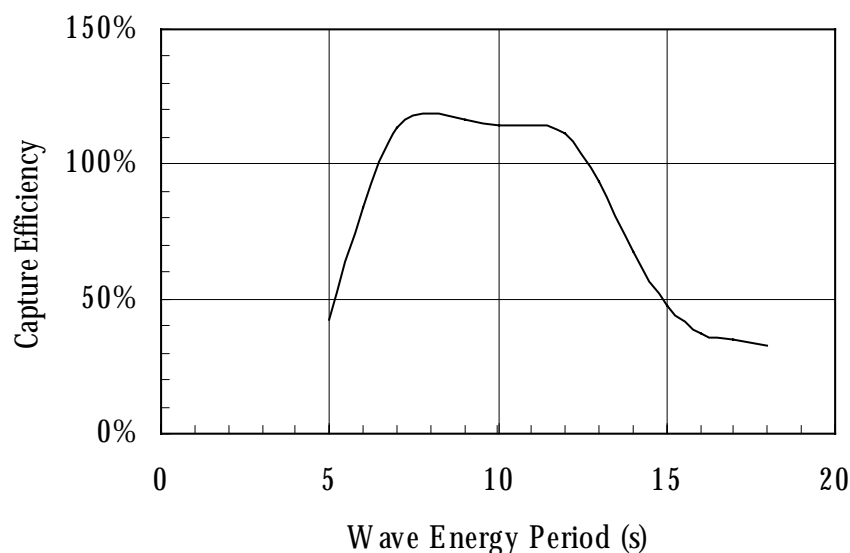
#### Capture Efficiency

Capture efficiencies have been measured on a one hundredth scale model in wave tank tests (Figure 6.17). It should be emphasised that the results are preliminary:

- the shape of the head is not optimised;
- the model has sharp corners and so loses energy by vortex shedding;
- the model is constrained to move in slope by the measurement rig and so is not behaving completely as it would in practice.

This capture efficiency was applied to the same sea states used in assessing the Frog (Table 6.1). The average capture efficiency was 81%. This is the major area of uncertainty in calculating the economics of the device and more information is needed on the efficiency of the device in unconstrained motion.

**Figure 6.17 Effect of Wave Period on the Capture Efficiency of the Sloped IPS Buoy**



### Efficiency of the Power Chain

Conversion of the captured energy into electricity would involve losses the various parts of the power chain as indicated in Table 6.4. This assumes a high efficiency hydraulic motor, such as that developed by Edinburgh University for their design for a wave energy device (Salter and Rampen, 1993).

### Availability

The overall availability was calculated as part of this review to be 90 %, allowing for repair and planned maintenance.

### Output of the Sloped IPS Buoy

The above estimates have been summarised in Table 6.4, which indicates that the average annual output for an MWP is 7.77 GWh.

### Capital Costs of the Sloped IPS Buoy

An independent assessment of the capital costs of the MWP was undertaken as part of this review, assuming that the device would be deployed as a small-scale scheme of 10 units. The predicted cost was just over £ 3.5 M per device with a cost breakdown as shown in Figure 6.18.

### O&M Costs

An estimate of the annual O&M rate was based on the above estimates of availability and component costs. This predicted an annual cost of ~ £ 46,000 per device. In addition there would be a one off cost for spares of £ 21,000 per device.

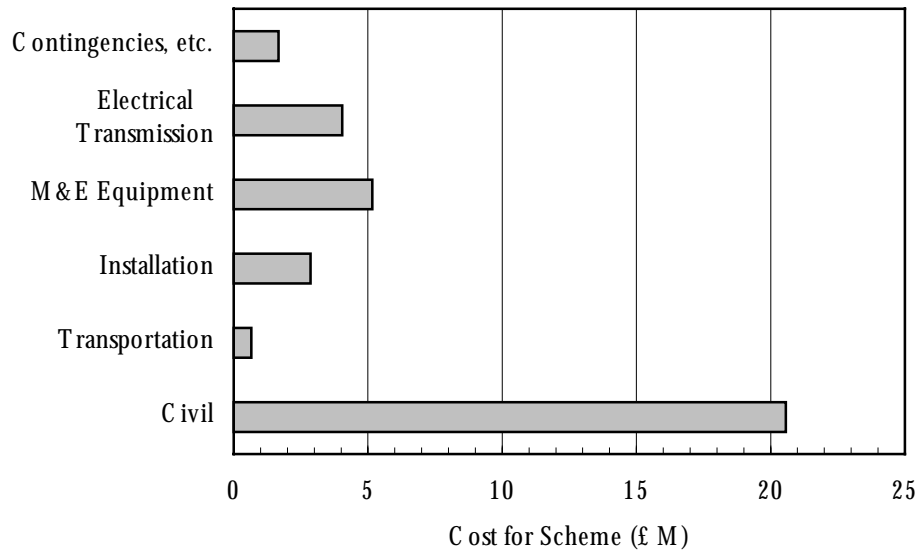
### Cost of Electricity Generation from the MWP

The costs of electricity generation at various discount rates have been calculated for and the results have been plotted in Figure 6.19.

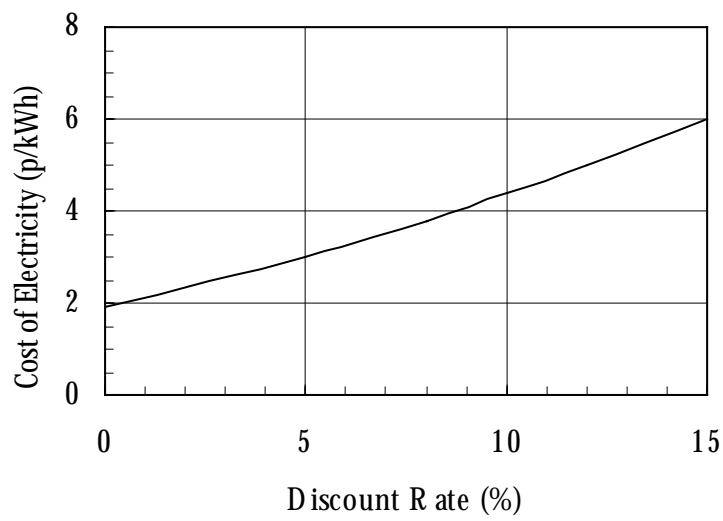
**Table 6.4 Summary of the Characteristics of the Sloped IPS Buoy**

Device Width	30 m
Directionality factor	0.94
Mean power	1495 kW
Capture efficiency	81 %
Power Captured	1212 kW
Conversion efficiency	92 %
Generator efficiency	88 %
Availability	90 %
Average Power Out	985 kW
Annual Output	7.77 GWh

**Figure 6.18 Breakdown of Capital Cost of a Sloped IPS Buoy Scheme**



**Figure 6.19 Effect of Discount Rate on Generating Costs of Sloped IPS Buoy**

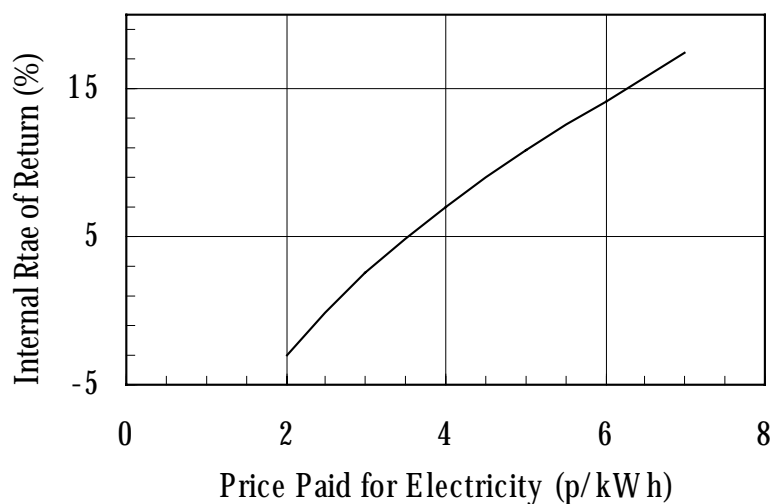


These generating costs should be taken as indicative; as with other devices, the costs could be lower if the deployment location were optimised. In addition, confirmation of the capture efficiency of the device undergoing unconstrained motion is required.

**Internal Rate of Return**

The internal rate of return was calculated for this particular scheme. The results (Figure 6.20) show that a positive rate of return is achieved if the price paid for electricity is greater than ~ 2.5 p/kWh.

**Figure 6.20 Internal Rate of Return on a Sloped IPS Buoy Scheme**



**6.4 SUMMARY**

The devices discussed in this Chapter represent an important development in wave energy. This can be illustrated in a number of ways.

- They can achieve a positive rate of return at electricity prices close to the existing pool price (Figure 6.21), although a significantly higher price is required to achieve an acceptable rate of return.
- Their capital costs are relatively small (~ £ 1M\*), making it easier to find the funding for that stage in their development;
- They utilise mainly existing, proven technology.

However, the generating costs and IRR predicted should be treated with some caution for a number of reasons:

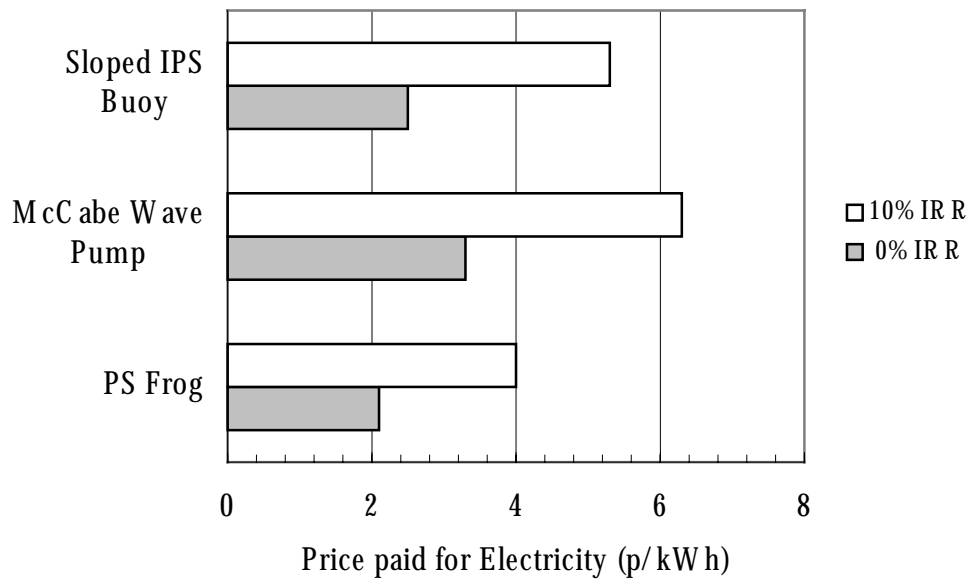
---

\* The prototype sloped IPS buoy could be made narrower, thereby reducing costs from their current values.

- There are gaps in the detailed knowledge of these schemes;
- The devices are not yet optimised;
- A representative location has been chosen **not** an optimum location.

Nevertheless, this class of point absorber appears to be the next logical step in development beyond the shoreline/nearshore OWC.

**Figure 6.21 Output per Unit Costs of Wave Energy Devices**







## 7 Overseas Activities

Next year sees the bicentenary of the first patent on a wave energy device by Girard (*père et fils*). However, in comparison with other, more recent renewable energy technologies, little of this renewable energy resource has been exploited. In the past two decades, there has been increasing interest in wave energy and financial support for its development. As a consequence, there have been numerous prototype devices tested in the sea and several new devices (including commercial schemes) are scheduled for deployment in the near future.

This Chapter presents a brief overview of these wave energy activities.

### 7.1 SHORELINE DEVICES

These devices are fixed to or embedded in the shoreline itself, which has the advantage of easier maintenance and/or installation. In addition these would not require deep water moorings or long lengths of underwater electrical cable. However, they would experience a much less powerful wave regime. This could be partially compensated by natural energy concentration (“hot spots” – see Section 2.1.1, page 8). The deployment of such schemes could be limited by requirements for shoreline geology, tidal range, preservation of coastal scenery, etc.

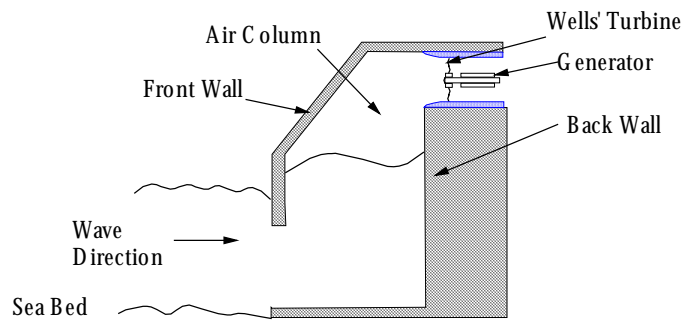
#### 7.1.1 Oscillating Water Column (OWC) Devices

One major class of shoreline device is the oscillating water column, (OWC), as described in Chapters 3 and 4 (Figure 7.1a). A number of OWC devices have been installed world-wide, with several of them being built into a breakwater to lower overall construction costs.

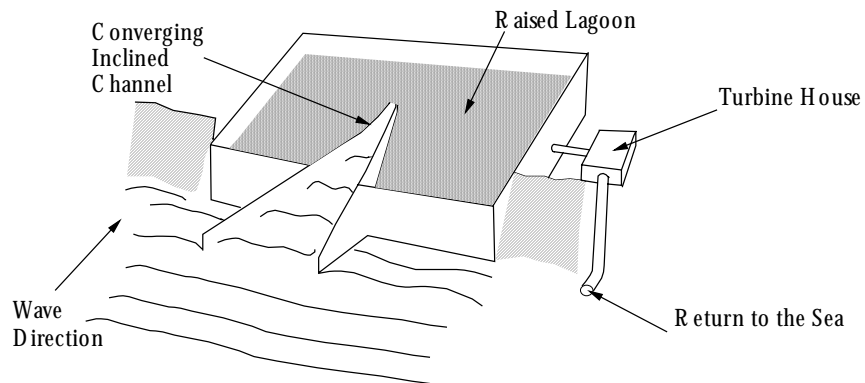
- In 1985, a 500 kW shoreline OWC was installed at Tofteshallen in Norway. This demonstration scheme functioned well until destroyed in a storm three years later (White, 1989).
- A 150 kW prototype OWC was built onto the breakwater of the Vizhinjam Fisheries Harbour, near Trivandrum in India in 1991 (Ravindran, 1995). This scheme has functioned well, producing data that have been used to design and build an improved demonstration scheme at the same site. Following the successful testing of this, it is proposed to build a commercial scheme of 10 caissons, with an overall rating of 1.1 MW, at Thangassery, on the west coast of India.
- A five chambered OWC was built as part of the harbour wall at Sakata Port in Japan (Hotta, 1995; Miyazaki, 1993). The device became operational in 1989 but, after a test programme, only three air chambers were used for energy

**Figure 7.1 Shoreline Wave Energy Devices**

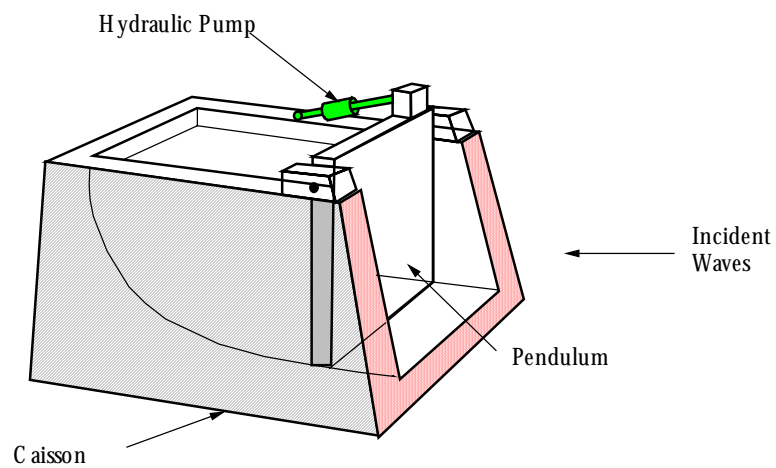
**Figure 7.1a. OWC Gully Device**



**Figure 7.1b Tapered Channel Device (TAPCHAN)**



**Fig. 7.1c Pendulum Device**



production. A turbogenerator module of 60 kW has been installed and is being used as a power generator unit for demonstration and monitoring purposes. This is expected to be replaced later by a larger and more powerful turbine (possibly 200 kW).

- In 1983, a 40 kW steel and concrete OWC was deployed on the shoreline structure at Sanze, Japan for research purposes (Hotta, 1995; Miyazaki, 1993). This functioned for several years and was then decommissioned and examined to investigate its resistance to corrosion and fatigue.
- A scheme comprising 10 OWCs was installed in front of an existing breakwater at Kujukuri-Cho in Japan (Hotta, 1995; Miyazaki, 1993). The air emitted from each OWC was manifolded into a pressurised reservoir and used to drive a 30 kW turbine.
- A prototype 130 kW OWC was deployed at Haramachi, Japan in 1996 (Hotta, 1995). This uses rectifying valves to control the flow of air to and from the turbine, in order to produce a steady power output. Tests on this device continue.
- An experimental 3 kW shoreline OWC was installed on Dawanshan Island in the Pearl river estuary in China (Zhi *et al.*, 1995). This supplied electricity to the island community and, following its good performance, it is being upgraded with a 20 kW turbine.

Studies for a European pilot OWC plant started in 1992 under the sponsorship of the European Commission (Russell and Diamantaras, 1995). The construction of the plant, which will be equipped with a 500 kW Wells' turbo-generator, started in 1995 on the shoreline of the island of Pico, Azores. The plant is expected to become operational by mid-1999 and will serve as a test bed for wave energy components and sub-systems (e.g. a variable pitch Wells' turbine and relief valve).

As described in Chapter 3, following the deployment and testing of the prototype OWC on the island of Islay in Scotland, the Queens University of Belfast and Wavegen are currently constructing a LIMPET OWC also on Islay.

### 7.1.2 Tapered Channel Devices (TAPCHAN)

The TAPCHAN comprises a gradually narrowing channel with wall heights typically 3 to 5 m above mean water level (Figure 7.1b). Waves enter the wide end of the channel and, as they propagate down the narrowing channel, the wave height is amplified until the wave crests spill over the walls to the reservoir, which is raised above sea level. The water in the reservoir returns to the sea via a conventional low head turbine, which generates a stable output due to the storage effects of the reservoir.

A demonstration device with rated output of 350 kW began operating in 1985 at Toftesfallen, in Norway. The device functioned successfully until the early 1990s, when work on modifying the device destroyed the tapered channel.

The potential market for such a device is limited within Europe, because the design requires (*inter alia*) a small tidal range. Therefore, this device would be better suited to islands and discussions have taken place for the construction of a 1.1 MW scheme at Baron, Java (Tjungen, 1995). There have been plans to utilise natural features such as coral reefs to

provide a reservoir, which would improve the economics of this type of device. However, such plans have not yet been implemented.

### 7.1.3 The Pendulor Device

A 5 kW Pendulor test device has been operating in Hokkaido since 1983. It consists of a rectangular box, which is open to the sea at one end (Figure 7.1c). A pendulum flap is hinged over this opening, so that the actions of the waves cause it to swing back and forth. This motion is then used to power a hydraulic pump and generator. On the basis of the results from this scheme, a new Pendulor device was designed and installed in 1994; it continues to produce new test data (Osanai *et al*, 1995; Watabe *et al*, 1995).

## 7.2 OFFSHORE DEVICES

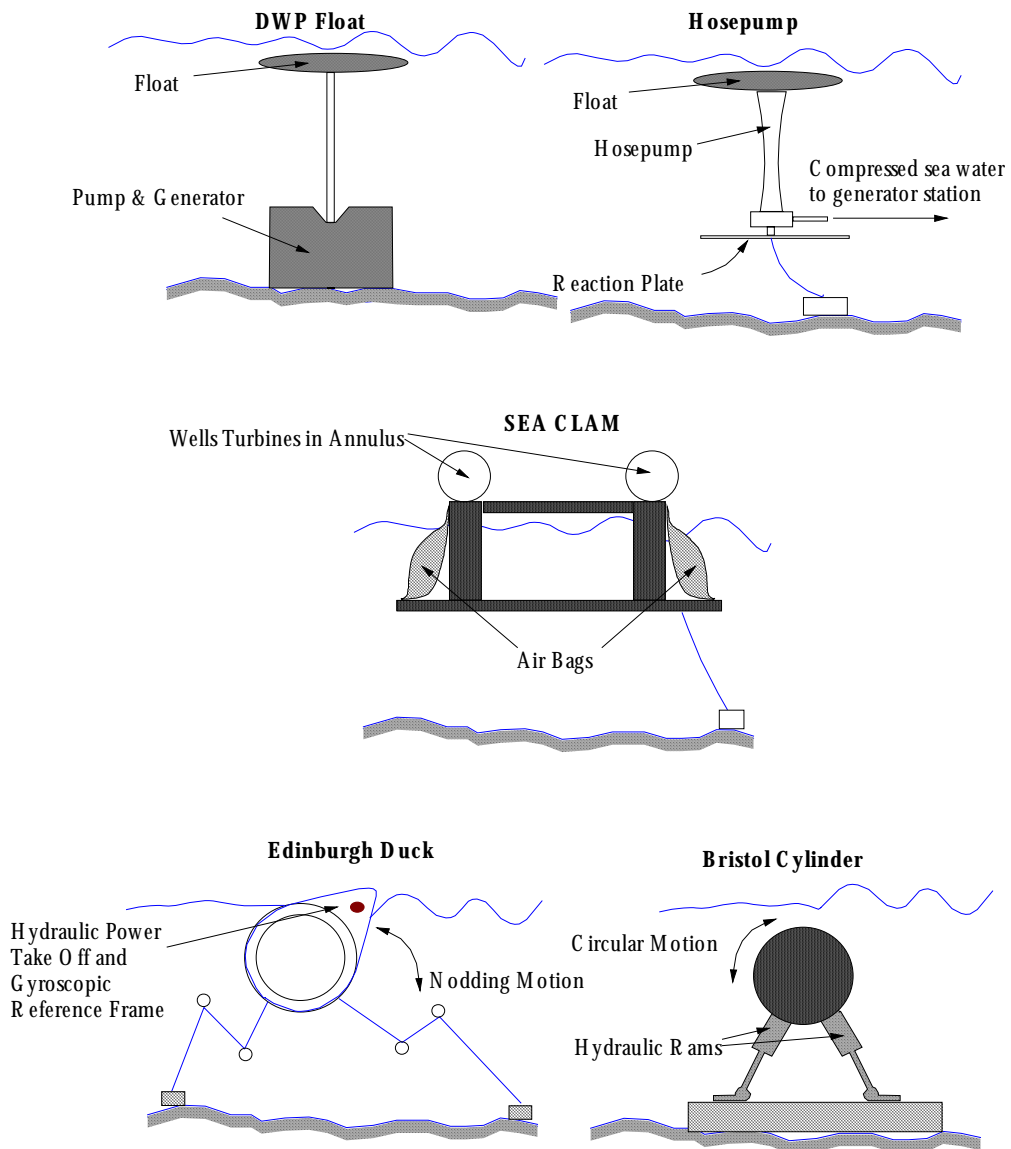
This class of device exploits the more powerful wave regimes available in deep water (> 40 m depth) before energy dissipation mechanisms have had a significant effect. In order to extract energy from the waves, the devices need to be at or near the surface (i.e. floating) and so they require flexible moorings and electrical transmission cables. There are many different types of offshore device, some of which are shown in Figure 7.2. These have been chosen since they represent broad classes of device and mechanisms by which power is extracted from waves.

### 7.2.1 Float-Based Devices

The simplest concepts extract energy from the vertical motion of a float as it rises and falls with each wave. If the motion of the float is reacted against an anchor or other structure that resists motion, then energy can be extracted.

In the Danish Wave Power (DWP) device, this is achieved by anchoring the float to a pump and generator mounted in a concrete box on the sea bed (DWP, 1996; Nielsen *et al*, 1995). Following developmental work, a 1 kW test device was installed near the harbour of Hanstholm, Denmark. This incorporated an air reservoir, which acted as an energy storage system, thereby smoothing the device output. After some initial difficulties, this device performed continuously for several months providing considerable amounts of information, which will be used in the further development of this scheme.

**Figure 7.2 Offshore Wave Energy Devices**



Another example of a device using a float is based on the Hosepump, which is a specially reinforced elastomeric hose whose volume decreases as it is stretched. The interior of the Hosepump is filled with sea water, which is pressurised as the float rises. By using a non-return valve, the device can supply pressurised sea water to a line connecting several Hosepump modules together. This line supplies sea water to a conventional Pelton turbine at pressures between 1 and 4 MPa (Bergdahl, 1979). Laboratory testing of the Hosepumps was followed by the installation of a single, small-scale module in Lake Lygnern. Later a larger system, comprising five modules connected in parallel to a single turbine and generator, was installed in Lake Lygnern. During 1983-4 a plant of three modules with

turbine and generator was installed in the open sea at Vigna. Despite loss of early systems in storms, a costing exercise was carried out on a 64 MW station comprising 360 modules for emplacement off the Norwegian coast (GES, 1984).

The performance of the system was good enough to encourage recent interest in commercial exploitation in using Hosepumps to power navigation buoys. Technocean (Sweden) are conducting trials of Hosepump/IPS buoy systems in and have plans for commercial systems in Europe in 1999.

### 7.2.2 Pneumatic Devices

Other concepts for offshore devices utilise air as the medium for generating electricity. One obvious form is that based on a floating OWC. This was developed in the UK Wave Energy Programme but was discontinued in favour of the bottom-fixed nearshore device. However, recently Japan has been developing a large, floating OWC known as the “Mighty Whale” (Hotta *et al*, 1995). This has been the subject of considerable research and a prototype has been deployed.

The other main type of pneumatic device uses a flexible membrane or bag to enclose a volume of air. As the bag is periodically compressed by wave action, it drives air through a turbogenerator. The main work in this area was carried out by Coventry University on a circular design, where the side mounted flexible bags pressurised an annulus which contained several Wells’ turbines (Coventry, 1986). This concept was developed further, leading to an outline design for a prototype 2.5 MW unit called the SEA Clam (Lockett, 1991; Peatfield, 1991).

### 7.2.3 Moving Body Devices

The most sophisticated type of offshore device uses a solid body which moves in response to the wave action or motion of water particles. Many different moving body concepts have been developed of which Figure 4.1 shows only two of the best known: the Edinburgh Duck and the Bristol Cylinder. The Duck is discussed in Chapter 5 and other moving body devices such as the McCabe Wave Pump and the PS Frog are discussed in Chapter 6.

In the case of the Cylinder a large, floating concrete mass undergoes circular motion due to wave action (McAlpine, 1981 and 1982). This is reacted against a platform fixed to the sea bed. In the original design, the relative movement of the cylinder was used to operate a number of elastomeric Hosepumps (see Section 7.2.1). These pressurised sea water, which was fed by a series of pipes to a central generating station where a Pelton turbine was used to generate electricity. The design was further developed by using hydraulic rams instead of Hosepumps (Shawater, 1992). In this case, the high pressure oil from the rams is collected and used to drive an electrical generator associated with each cylinder.

#### 7.2.4 Hydroelectric Devices

Another type of device is similar to a Tapchan. It consists of a floating box enclosed on three sides with a sloping ramp on the fourth side facing into the waves. The waves sweep up the ramp and into an internal reservoir, from which the water is allowed to escape back to the sea via a low head turbine. Several designs have been produced in which the shape of the ramp and wave collector varies (Bergdahl, 1992; Kofoed *et al*, 1998), with one design having been selected for inclusion in the Scottish Renewables Order.

### 7.3 RECENT INTERNATIONAL WAVE ENERGY ACTIVITIES

Most of the most recent wave energy activities have been concentrated in Europe, India and Japan. This Chapter will present a brief overview.

#### 7.3.1 The European Wave Energy Programme

The main areas of activity of this programme include (Russel and Diamantaras, 1995):

- Experimental OWC pilot plants;
- A European wave energy atlas;
- Evaluation of offshore wave energy converters;
- Evaluation of power take-off turbines;
- Design of shoreline OWC;
- Evaluation of a novel wave energy conversion system.

The most important of these areas will be reviewed briefly.

#### Experimental OWC Pilot Plants

There are two pilot plants that have received funding under the JOULE programme: the Wavegen OWC and a shoreline OWC in the island of Pico in the Azores. These are intended to “demonstrate the technical feasibility of the devices and to improve the technology” (Russel and Diamantaras, 1995). The Wavegen scheme has already been described, so only the Azores plant will be considered here (Falcão *et al*, 1995).

The plant is a square concrete structure with an area of 144 m<sup>2</sup> that will sit in a natural harbour at Porto Cachorro, where extensive wave measurements have been made. The OWC plant has been tested as a model at 1:25 scale to optimise the geometry of the OWC chamber and its damping (Brito-Melo *et al*, 1995; Holmes *et al*, 1995). This modelling established the importance of using a relief valve and variable pitch Wells’ turbine, which are being designed and tested by Edinburgh University (Taylor and Salter, 1995). However, the device will initially use a fixed pitch Wells’ turbine with guide vanes, having a diameter of 2.3 m and a rating of 560 kW, which is being supplied by Wavegen. This will be coupled to a 400 kW wound induction motor, which operates in a similar manner to that previously used on the Islay OWC (e.g. the scheme has some energy storage capability). Output to the transmission system is via a Kramer link (a rectifier-inverter system).

### **The European Wave Energy Atlas**

This is a PC database of the deep water wave climate along the Atlantic and Mediterranean coasts of EU member states (Russel and Diamantaras, 1995). The data are derived using hindcasting analysis using the WAM model and, where possible, verifying the findings with measured data (Athanasoulis *et al*, 1995; Pontes *et al*, 1995). The model produces several types of output, including:

- Probability density functions of  $H_s$  and  $T_e$ ;
- Exceedance distributions of  $P_i$ ;
- Two dimensional histograms of  $(H_s, T_e)$ .

Eventually the model will also provide directional data. The Atlas is a very useful and user-friendly tool providing a consistent method for wave energy resource evaluation. However, at the moment it does this for only deep water locations. Eventually, it is hoped to extend the system permitting the calculation of nearshore wave energy climates.

#### **7.3.2 The Indian Wave Energy Programme**

The Indian wave energy programme started in 1983 at the Institute of Technology, Madras and has concentrated almost exclusively on the OWC concept. A 150 kW prototype OWC with harbour walls was built onto the breakwater of the Vizhinjam Fisheries Harbour, near Trivandrum in India in 1991 (Ravindran, 1995). This scheme has functioned well, producing data that have been used to design and build an improved demonstration scheme at the same site. This will have the following new features:

- The squirrel cage induction generator will be superseded by a slip ring, variable speed induction generator which will have an improved performance under fluctuating load conditions;
- The previous device had windage losses of 15 kW, which had to be supplied from the grid under low wave energy conditions. The new scheme will comprise two power modules, only one of which will run under low power conditions to reduce such losses.
- The fixed chord blade turbine will be replaced by one with a tapered chord for improved efficiency.

Following the successful testing of this, it is proposed to build a commercial scheme of 10 caissons, each 21 m wide, at Thangassery, on the west coast of India. Each caisson will have two power modules, both with a 55 kW rating, leading to an overall rating of 1.1 MW. These caissons will be spaced at an optimum distance apart, in order to increase their overall capture efficiency to above that of a single caisson.

#### **7.3.3 The Japanese Wave Energy Programme**

The most important aspect of this programme is that it has focused on construction and deployment of prototype devices. Most of these have been described elsewhere in this review and so no further details will be given here.

#### **7.3.4 Other Wave Energy Activities**

Wave energy activities continue in other countries, albeit at a low level, and several new countries are starting to take an interest in the area. Some of these are outlined below.



### **Australia**

Energetech Wave Energy Systems have plans to use a large, parabolic bay to focus waves onto a shore based OWC system, incorporating a novel turbine. This arrangement has the promise of improved capture efficiencies and higher turbine efficiencies, which could lead to significant improvements in the economics of OWCs. An agreement has been reached for the deployment of the first commercial scheme on the east coast of Australia.

### **Korea**

Baek Jae Engineering have designed a prototype wind-wave energy scheme. This design has many novel features, in particular a floating, lattice structure fabricated from plastics and composites. The new aspects of the design are intended to reduce the overall capital cost of the scheme by minimising the non-productive wave loading on the device and utilising a cheaper construction material. The design is at an early stage of development and, as such, there are several aspects that need further development. However, this is typical of a technology at this stage of development (i.e. pre-prototype phase). An independent assessment has been carried out which indicated that, if research in these areas are successful and the device lives up to its early promise, it is likely to be economically competitive with a range of electricity generation technologies (both conventional and from renewable energy sources) if deployed in energetic wave climates such as those of Western Europe. Baek Jae Engineering are continuing to develop the design and are intending to progress to testing a prototype in the near future.

### **Netherlands**

Teamwork Technology have announced the start of a pilot point absorber scheme in the waters off Portugal. This is based on the Archimedes Wave Swing, which utilises pressure variations under passing waves to alter the buoyancy of a float. The resulting changes apply forces to a tether which actuates a hydraulic system and generator.

### **Spain**

Since 1990, Unión Eléctrica Fenosa of Spain has been conducting research on a novel wave energy scheme (Matas, 1992). The scheme is an OWC where the power is extracted not by an air driven turbine but mechanically, using a float atop the water column. An experimental plant has been tested in a wave flume, allowing its behaviour to be modelled. More testing is being carried out but plans are being made for installation of a prototype in a breakwater (Rebollo, 1995).

### **USA**

A US company (Ocean Power Technology) has plans to deploy small buoys (~ 20 kW each) in arrays as commercial schemes in several locations world-wide. This OPT Wave Energy Converter is derived from a novel application of the theoretical Swedish IPS buoy concept. Large-scale tests have already been undertaken in the sea off New Jersey and agreements have been reached for the first commercial schemes in several regions in the Pacific. This device has the benefit of using mainly off-the-shelf technology, which enables it to be constructed very cheaply.



# 8 Environmental Impacts of Wave Energy

All forms of electricity generation have an impact upon the environment but it is generally perceived that wave power is less environmentally degrading than some other forms of power generation, especially in relation to atmospheric emissions. Wave energy devices produce no gaseous, liquid or solid emissions and hence, in normal operation, wave energy is virtually a non-polluting source. However, the deployment of wave power schemes could have a varied impact on the environment. Some of the effects may be beneficial and some potentially adverse. This Chapter presents a brief outline of the possible effects and an estimation of the life cycle emissions associated with a typical nearshore device, the OSPREY. In general these impacts will be greatly reduced for floating offshore devices and increased for shore-based devices.

## 8.1 POTENTIAL IMPACTS

The limited experience with wave power schemes makes it possible to form only an incomplete picture of possible environmental effects caused by wave power devices. This is reflected in Table 8.1 which summarises potential impacts. Many of the potential impacts would be site specific and could not be evaluated until a location for the wave energy scheme is chosen. The main effects that wave devices may have are discussed below, together with areas of uncertainty with our present level of knowledge.

### 8.1.1 Hydrodynamic Environment

Wave energy converters may have a variety of effects on the wave climate, patterns of vertical mixing, tidal propagation and residual drift currents. The most pronounced effect is likely to be on the wave regime. A decrease in incident wave energy could influence the nature of the shore and shallow sub-tidal area and the communities of plants and animals they support. Fixed structures such as the OSPREY are more likely to alter the wave climate than floating devices.

Previous work in this area is limited, although modelling carried out for the assessment of wave energy converters off the coast of the Outer Hebrides indicated that devices tuned to medium period waves and sited less than 30 km offshore would reduce wave steepness at the shore and affect the sedimentary budget, favouring accretion (Probert and Mitchell, 1979 and 1983). However the extent of this accretion may be minimal as material available for mobilisation may be limited.

**Table 8.1 Possible Environmental Impacts of Wave Energy Devices**

<b>Environmental Effect</b>	<b>Size</b>
Construction/maintenance sites	S
Recreation	S
Coastal erosion	S-M
Sedimentary flow patterns	S
Navigation hazard	S
Fish & marine biota	S
Acoustic noise	S
Endangered species	S
Device/mooring damage	S-M

**Key:** S - small, M - medium, L - large

Changes to the wave regime along the shoreline would change the composition of the shoreline and possible near shore subtidal communities. Any large-scale scheme would require a full feasibility study to determine the effects on sedimentary processes within the region and the flora and fauna typical of the region.

### 8.1.2 Devices as Artificial Habitats

Interactions between devices and the marine environment are made more complex by the fact that the devices would represent new habitats. Offshore oil and gas installations provide attachment surfaces for a variety of algae and invertebrates, so wave energy converters would be colonised by fouling organisms. The species recruited to these sites would depend on the species' communities within the vicinity of the device, distance offshore, water depth and clarity, prevailing weather conditions and position relative to coastal currents and the speed of those currents (Thorpe and Picken, 1993). There would be a seasonal factor involved in the build up of this community with the main build up of fouling extending from about April to November.

It is inevitable that anti-fouling measures would be necessary where, for instance, attached organisms cause changes in corrosion and fatigue behaviour, hinder inspection and maintenance, etc. Fouling prevention measures specific to wave energy converters have yet to be developed, but could include the use of anti-fouling paints or direct injection of biocides. Fouling of sea water conduits at coastal power stations has been controlled by injection or electrolytic generation of chlorine. Due to the effects of dilution it is not clear if the use of this measure at a more open sea location might be environmentally harmful. Certainly chronic impacts may result if the chlorine was allowed to react to form chlorinated organics which tend to bioaccumulate and persist in the environment, although this would appear to be unlikely in open waters. There are numerous options for the removal of marine fouling, each of which has its relative merits. None of these pose any significant environmental problem although some (e.g. high-pressure jets) could be hazardous to the user.

Artificial structures can be very effective in concentrating pelagic fish depending on such factors as water clarity (i.e. visible range of the structure), distance offshore and depth, which influence the species likely to be available. It is nevertheless probable that if fish were to use such structures for shelter, fish eating seabirds and marine mammals would be attracted to device arrays. Both these aspects could enhance opportunities for local employment by increased fishing and tourism.

There is a need to consider what would happen to wave converter arrays at the end of their working life. Relinquishing sea bed mounted devices to natural erosion or reducing them to rubble on the seabed would cause a permanent alteration to the inshore environment; they would in effect become reefs. Construction of artificial reefs to increase habitat diversity of an area of seabed and attract fish is a widely used technique globally, although it is still in its infancy in the UK (Collins, Jensen and Lockwood, 1991). However, diversity is not always an attribute when assessing the marine conservation of an area and the influence of artificial reefs on the population of marine creatures can be unpredictable and vary from species to species (Todd, Bentley and Kinnear, 1992). Creation of reefs may also affect the ability to fish an area using trawl nets, due to snagging of nets on submerged structures. Nevertheless, the overall environmental influence of such reefs is likely to be positive, providing they are not situated in environmentally sensitive or important areas.

### **8.1.3 Noise**

Some wave energy devices are likely to be noisy especially in rough conditions. Noise travels long distances underwater and this may have implications for the navigation and communication system of certain animals principally seals and cetaceans. It is thought unlikely that cetaceans would be affected as much of the noise likely to be generated is below the threshold hearing level (frequency) for dolphins. Whales use a number of wave lengths for communication and sonar. Simple experimental evidence could be derived using hydrophones to measure both whale and device sound spectrum in order to determine if there are any areas of overlap which may cause interference to whales. Whales and dolphins manage to miss most barriers placed in the water, except possibly for fine mono-filament nets, which would obviously not be used in wave energy devices. However care needs to be exercised that the devices do not cause interruptions to migratory pathways or breeding grounds. The degree of such interruptions is likely to be matched by the size of the device and would most likely to be a problem if long lengths (tens of kilometres) of wave energy converters were deployed.

For near shore/shoreline devices, the levels of noise may potentially constitute a nuisance on the shore. However, when the device is fully operational the device noise is likely to be masked by the noise of the wind and waves, providing adequate sound baffling is used.

### **8.1.4 Navigational Hazards**

Wave energy devices may be potential navigational hazards to shipping as their low freeboard could result in their being difficult to detect visually or by radar. Detailed recording of the positions of devices together with proper marking of devices using lights and transponders should minimise this risk. In large arrays navigational channels would

have to be allowed for. Several of the areas proposed for wave energy devices around European coasts are in major shipping channels and hence there is always an element of risk that a collision may occur. The result, for example, of an oil tanker colliding with an array may have consequences for colonies of seabirds in the locality.

#### **8.1.5 Visual Effects**

In some areas, the water depth required by the near shore devices might be attained only a few hundred yards offshore. Such schemes and shoreline devices would have a visual impact. Such schemes may be particularly sensitive in areas of designated coastline and those used for recreational purposes. Considerable work is now being done within the UK, by the Department of the Environment, local authorities and voluntary organisations, to examine the issue of coastal zone management and it may be necessary to plan for the future inclusion of wave power in management plans developed.

#### **8.1.6 Leisure Amenity**

Offshore and nearshore devices could have an effect on some forms of recreation. The precise effect would vary with the type of recreation (e.g. sub-aqua diving and water skiing might benefit from the shelter provided by these devices but sailing and wind surfing might suffer).

#### **8.1.7 Device Construction**

Other major impacts of wave energy conversion on the natural environment would result from the construction and maintenance of devices and any general associated development. Many of these implications are unlikely to be peculiar to wave energy devices but it is essential that they are taken into account in the environmental assessment process. It is probable that existing shipyard sites would be used with minimal additional environmental impact.

#### **8.1.8 Conversion and Transmission of Energy**

Transmission lines are required to transfer the electricity generated to the places it is required. Initially cables are likely to run on the seabed and, although laying underground may be possible on particular shorelines, the cost implications suggest that overhead lines may be required with the consequent problems of visual intrusion in areas of high landscape value.

On certain shorelines which may hold significant populations of waterfowl, overhead transmission lines can have an effect on the mortality of certain species, especially large migratory species which have limited manoeuvrability. Most collisions appear to occur where lines intersect flyways between roosting and feeding grounds.

## **8.2 ENVIRONMENTAL EFFECTS OF THE PROTOTYPE DEVICE**

An environmental assessment of a prototype OSPREY device off Dounreay in Scotland has been carried out (Environment & Resource Technology 1994). In general the report

anticipated few environmental impacts for the scheme, although this could change if more than one device were to be built there. The main impacts anticipated were as follows.

- *Local Fisheries.* Whilst the area is of little importance for commercial fishing (i.e. it is neither an area for trawling nor a spawning/nursery ground) it supports a creel fishery. The device could lead to loss of access, especially during the installation phase.
- *Sediment Disturbance.* There was insufficient information on the behaviour of sediments at these water depths to allow for a quantitative assessment of the likely disturbance. Nevertheless it was considered unlikely that there would be any significant build up of sediment in area of reduced wave activity behind the device.
- *Visual Impact.* The assessment was carried out on an earlier design of device (Figure 4) and concluded that "...the device would not be particularly intrusive to the existing view in daylight or at night time". However, since then the device has undergone further development. To comply with Northern Lighthouse Board requirements, it will have to be painted yellow and fitted with a revolving yellow light with a range of 2-3 miles. In addition, the current design is likely to incorporate a wind turbine. These features will significantly increase the visual impact of the device. However, it is to be located close to the existing Dounreay Nuclear establishment and so the marginal visual impact is likely to be minimal.

In general the environmental impacts of a prototype scheme have been thoroughly evaluated and are likely to be small. In addition, recommendations have been made to minimise impacts. However, the proposed incorporation of a wind turbine introduces potential new impacts which have yet to be evaluated (e.g. visual impact).

## 8.3 EMISSIONS

### 8.3.1 Introduction

Unlike conventional fossil fuel technologies, wave energy produces no greenhouse gases or other atmospheric pollutants whilst generating electricity. However, emissions do arise from other stages in its life cycle (i.e. during the chain of processes required to manufacture, transport, construct and install the wave energy plant and transmission equipment). Emissions from these stages need to be evaluated if a fair comparison of emissions from fossil fuel based generation and wave energy generation is to be made.

### 8.3.2 Life Cycle Stages for Wave Energy Technologies

For wave energy technologies, the typical stages of the life cycle are:

- Resource extraction;
- Resource transportation;
- Materials processing;
- Component manufacture;
- Component transportation;
- Plant construction;
- Plant operation;

- Decommissioning;
- Product disposal.

Ideally, each of the life cycle stages listed above should be considered, in order to evaluate the total emissions from the life cycle of the technology. However, an exact analysis of every stage is neither possible nor necessary. The emissions of most of the major air pollutants (particularly carbon dioxide, sulphur dioxide, oxides of nitrogen and particulates) are expected to be broadly proportional to energy use. Therefore, the most important life cycle stages for atmospheric emissions are those with the highest energy use. Detailed studies of the main renewable energy technologies have been carried out using this approach within the ExterneE study (e.g. Eyre, 1995) and elsewhere in the literature. This has shown that, for most renewables:

- The emissions released during the manufacture of the materials are the most important;
- Energy use in all of the transportation stages is likely to be negligible; energy use in freight transport is typically only 1 MJ/t/km for rail (Eyre and Michaelis, 1991) and in road transport is typically 3 MJ/t/km;
- Energy use in the extraction of the primary materials used in construction (e.g. limestone and aggregates) or in components (e.g. iron ore and copper ore) is typically an order of magnitude lower than energy use in their primary processing;
- Energy use in the construction, decommissioning and disposal processes is also likely to be at least an order of magnitude lower than for material manufacturing.

In assessing the energy use and emissions for technologies, data relating to realistic sites and technologies should be used, in recognition of the fact that these factors are important in determining the magnitude of some emissions. Emissions associated with the manufacture of materials and components are dependent (to some extent) on industrial practices, the generation mix and pollution control regime in the country of manufacture.

### 8.3.3 Calculation of Life Cycle Emissions

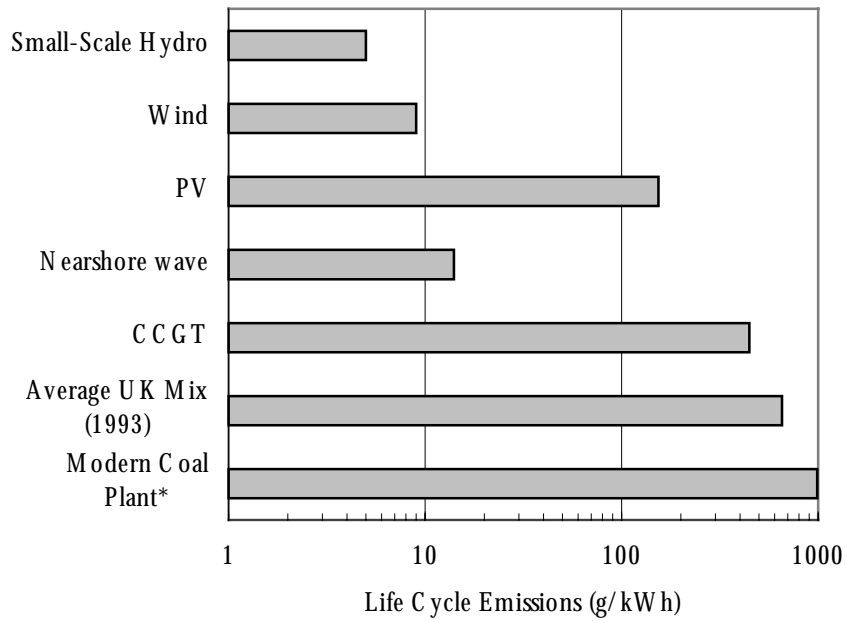
The above evaluation has been carried out for a range of technologies (Thorpe *et al*, 1998; Bates, 1995). The same methodology was used to determine the life cycle emissions of a representative wave energy device: the Wavegen OSPREY. The results for some renewables and wave energy are shown in Figures 8.1 to 8.3. In order to compare with the range of possible fossil fuel stations, three different fossil fuel technologies were chosen:

- Combined cycle gas turbines (CCGT).
- Modern coal plant (i.e. pulverised fuel with flue gas desulphurisation - PF+FGD).
- The UK generating mix (Bates, 1995).

It can clearly be seen that wave energy (and the other renewables) can offer significant reductions in the omissions of gaseous pollutants when compared to fossil-fuel based generation. The only exception to this is for CCGT, whose emissions of SO<sub>2</sub> are effectively zero.

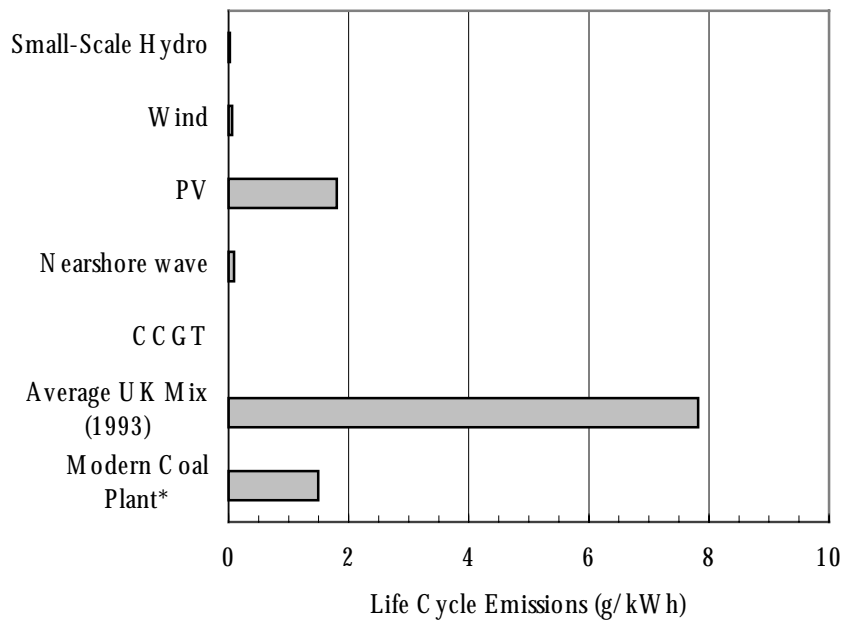


**Figure 8.1 Comparison of Life Cycle Emissions of CO<sub>2</sub>**



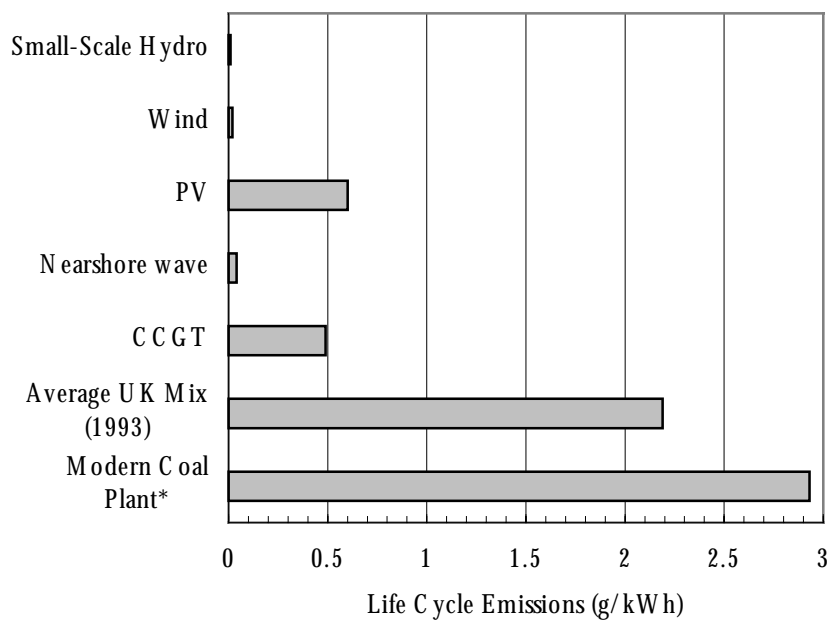
Key. \* = coal plant with flue gas desulphurisation and low NO<sub>x</sub> burners.

**Figure 8.2 Comparison of Life Cycle Emissions of SO<sub>2</sub>**



Key. \* = coal plant with flue gas desulphurisation and low NO<sub>x</sub> burners.

**Figure 8.3 Comparison of Life Cycle Emissions of NO<sub>x</sub>**



Key. \* = coal plant with flue gas desulphurisation and low NO<sub>x</sub> burners.

# 9 Discussion

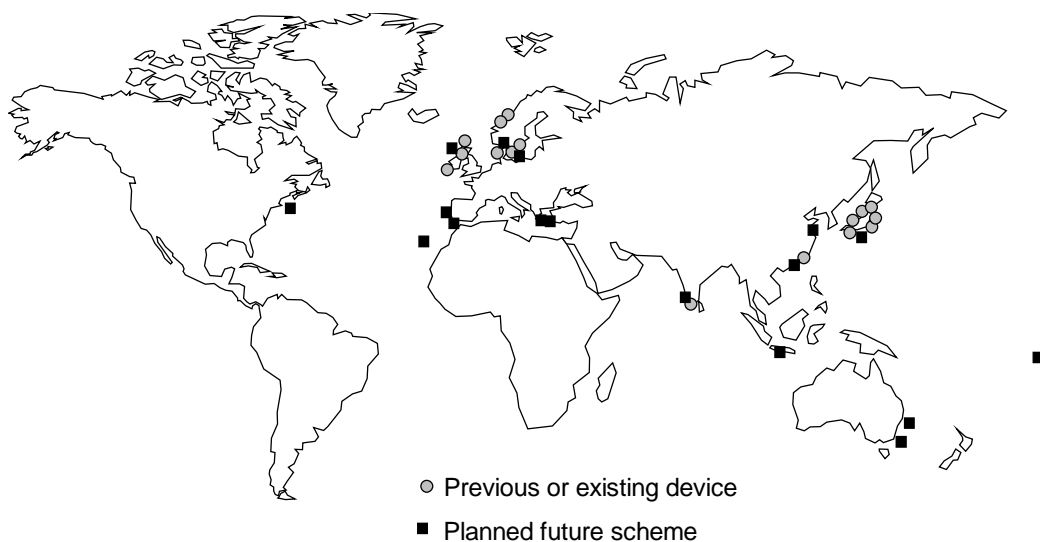
## 9.1 THE TECHNICAL STATUS OF WAVE ENERGY

The technical status of the devices covered in this Review varies widely. Some are already being built as full scale prototype or demonstration schemes, whilst others still require years of further research. Within the UK, there are only two devices considered in this review that are likely to be built in the near future: the Limpet and Osprey. Other devices have been proposed for inclusion in the latest Scottish Renewable Order, which could lead to their deployment in the near future but there is limited information available on them.

Despite its early pre-eminence in this field, the UK (with the notable exception of Wavegen and some universities) has failed to exploit this potential, whilst other countries with much less energetic wave regimes have either already deployed wave energy schemes or are planning to deploy them in the near future (Figure 9.1).

Most of the schemes shown in Figure 9.1 are OWCs, which are first generation devices. However, OWCs have still to achieve a satisfactory, long term performance. Therefore, this technology could be classified as being in the demonstration stage.

**Figure 9.1 Distribution of Wave Energy Schemes**



Other technologies that could fit into that category include the Japanese Pendulor and the Tapchan, whilst there are several other devices where demonstration or the first commercial

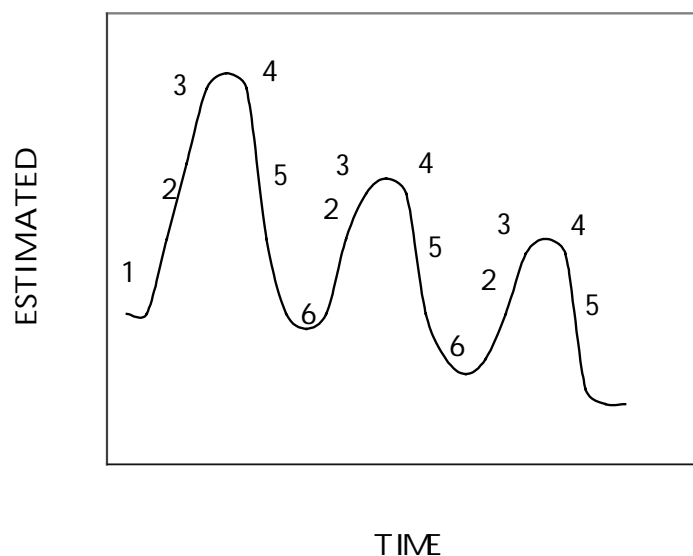
schemes are currently being built (e.g. the McCabe Wave Pump and the Ocean Power Technology Wave Energy Converter).

## 9.2 THE ECONOMIC STATUS OF WAVE ENERGY

### 9.2.1 Development of Predicted Generating Costs

The assessment of the commercial prospects for wave energy has been a hotly debated field. There are a number of historic reasons for this but, perhaps, there is one underlying cause: until the technology matures, estimates of the cost of power from wave energy devices “represent a snapshot of the status and costs of the designs at (the current) stages of their development” (Thorpe, 1992). Indeed, it is possible to identify trends in the economics of devices, that are similar to trends in costs of other developing technologies, as exemplified in Figure 9.2 (there can be other stages in this process but Figure 9.2 indicates the general behaviour). This exemplifies the uncertainty inherent in a cost estimate made at a particular time.

**Figure 9.2 Variation in Predicted Cost of Energy with Time**

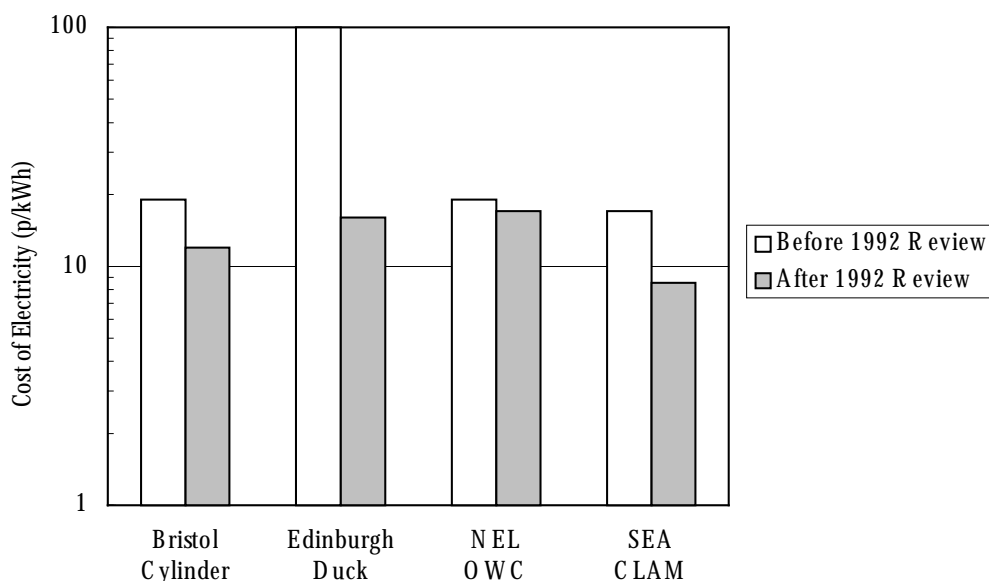


Key:

1. Initial idea - looks promising;
2. Idea researched, problems identified, predicted cost escalates;
3. Design fully worked out, predicted cost too high;
4. Radical design change or new approach;
5. Changes lead to a reduction in predicted cost;
6. New design looks promising and so adopted - back to stage 2.

The UK's last review of wave energy (Thorpe, 1992) played a role in this trend, with the predicted generating costs of several devices being reduced by factors of two or more as part of the review activities (Figure 9.3).

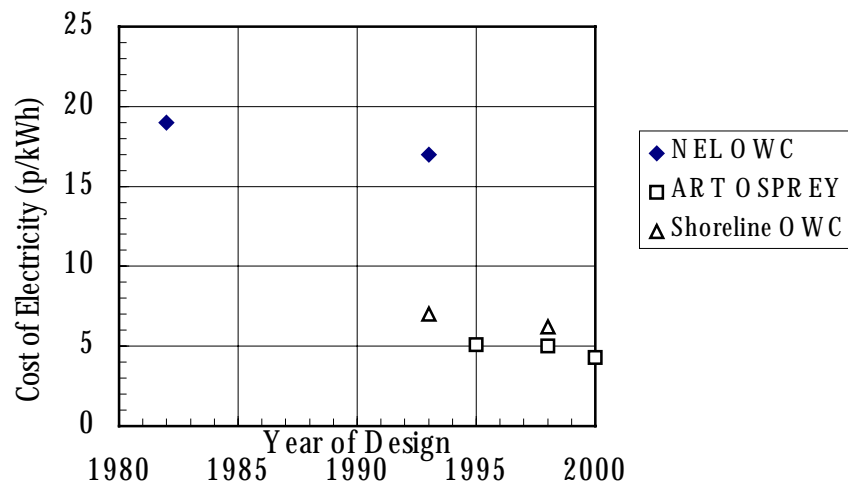
**Figure 9.3 Change in Predicted Electricity Costs in 1992 Review**



The electricity costs of the devices included in this current report were evaluated using the same peer-reviewed methodology developed for the last UK review of wave energy. The costs have been plotted in Figures 9.4 and 9.5 against the year in which the design of device was completed. These figures show that there have been significant improvements in the predicted generating costs of devices, so that there are now several with costs of about 5 p/kWh or less at 8% discount rate (if the devices achieve their anticipated performance). This indicates that, if these devices can be successfully built and operated, wave energy is already economically competitive in niche markets such as supplying electricity to isolated communities that are not connected to the grid. It has good prospects of being more commercially competitive with further R&D. In addition, designs such as the McCabe Wave Pump offer the chance for value added performance by providing desalinated water through reverse osmosis at economic rates.

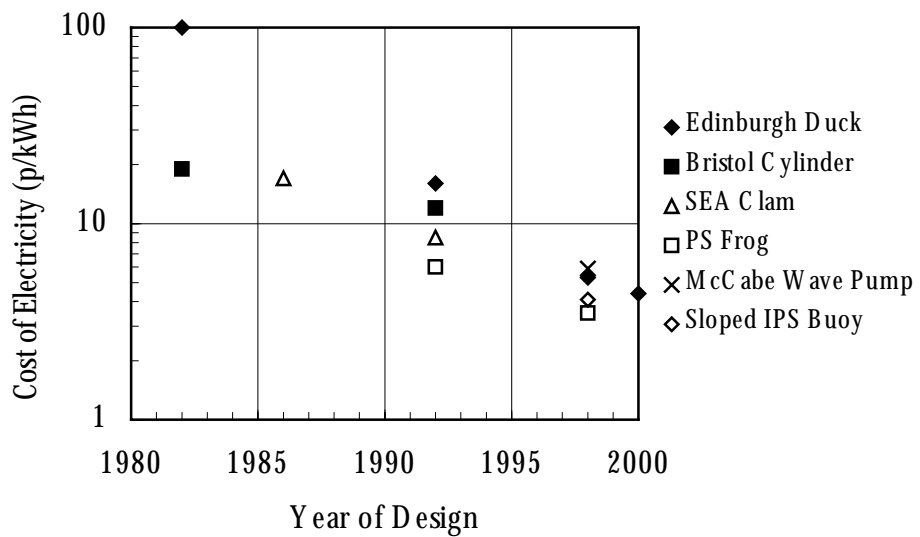
It should be noted that several of the design teams claim lower costs than those presented, for instance the Hosepump is claimed to have generating costs of 2.4 - 4 p/kWh (Eurowave, 1997). In addition, the economics of the schemes evaluated in this review could be improved even further if the devices were constructed overseas where costs are often cheaper.

**Figure 9.4 Evolution of Predicted Electricity Costs for OWCs\***



Key. \* at 8% discount rate.  
 Costs for year 2000 design incorporate improvements already quantified.

**Figure 9.5 Evolution of Predicted Electricity Costs for Offshore Devices\***



Key. \* at 8% discount rate.  
 Costs for year 2000 design incorporate improvements already quantified.

### 9.2.2 Uncertainties in Predicted Generating Costs

The determination of generating costs summarised in the previous Section assumed that all aspects of the various wave power schemes (e.g. construction costs, capture efficiencies, power chain losses, etc.) were precisely defined. This is unlikely to be the case for a technology such as wave energy, given its present state of development. Such uncertainties are attributable to a number of sources, which have been outlined in the relevant Sections in this report:

- Variability in performance characteristics, reliability, etc.;
- Spatial variability and lack of data on sea characteristics;
- Different estimates of construction and component costs;
- Lack of in-service data and the consequential dependence on model tests and theoretical predictions.

Until large-scale tests have taken place, the last of these bullet points will remain an important source of uncertainty. The potential effects of the uncertainties associated with the factors listed in the other bullet points can be assessed, albeit imperfectly.

An estimation of the variability of each key parameter was undertaken, as exemplified below.

- The uncertainty in capital costs was derived from a range of quotes for the supply of major components of the scheme (e.g. fabricated steel, reinforced concrete, generators, power controllers, etc.).
- The uncertainty in annual costs was based on:
  - Variations in the capital costs of items as described above;
  - Variations in estimated reliability, based on the range of reported reliabilities of key components (turbines, hydraulics, generators, etc.).
- The uncertainty in energy output was based on a number of factors:
  - Wave power levels. Whittaker *et al* (1992b) found that these were approximately normally distributed with a standard deviation of about 10% of the mean value;
  - Directionality factor. Earlier studies predicted a lower factor so a range of +0% to -10% was adopted for the values used in this review;
  - Variations in reliability (see above);
  - Variations in capture efficiency. Values above the deterministic predictions were derived from estimates of the effect of optimisation of the devices. Values below the deterministic predictions were derived in a number of ways, depending on the device (e.g. for the Slopped IPS Buoy, a suboptimal angle of inclination was used; with a corresponding reduction in capture efficiency from model tests).
  - Variations in power chain efficiencies. Values were derived from manufacturers' data sheets.

The average values of the major parameters and their associated distributions were then combined in a Monte Carlo analysis which predicted the resulting variation in overall electricity generating costs. In order to present such analyses for a range of relevant discount rates, the Monte Carlo calculations were repeated at 8% and 15% discount rates. The resulting distributions of predicted costs were then broken down into their lower, middle and upper quartiles.

- The lower quartile could be taken to represent the most favourable combination of all aspects of the scheme;
- The lower quartile could be taken as a representation of the risk involved in developing a scheme;
- The median could be taken to represent the most likely generating costs, following successful R&D.

The variability associated with each aspect of a particular scheme is listed in Table 9.1 and the predicted generating costs are listed in Table 9.2. The typical interquartile range is generally less than 20% of the median value.

**Table 9.1 Variability in Major Input Parameters**

Device	Variation in Capital Costs	Variation in O&M Costs	Variation in Annual Output
Limpet	-10% to + 20%	-30% to + 20%	-20% to + 20%
OSPNEY	-15% to + 30%	-35% to + 10%	-7% to + 30%
Duck	-12% to + 16%	-9% to + 12%	-30% to + 23%
PS Frog	-25% to + 40%	-10% to + 12%	-40% to + 20%
MWP	-5% to + 25%	-15% to + 30%	-30% to + 20%
Sloped IPS Buoy	-20% to + 27%	-20% to + 20%	-33% to + 38%

**Table 9.2 Predicted Generating Costs at Interquartile Probabilities**

Device	Cost @ 8% Discount Rate (p/kWh)			Cost @ 8% Discount Rate (p/kWh)		
	25%	50%	75%	25%	50%	75%
Limpet	5.6	6.2	6.9	8.9	9.7	10.7
OSPNEY	4.1	4.4	4.7	6.3	6.8	7.3
Duck	4.7	5.4	6.2	7.4	8.4	9.8
PS Frog	3.1	3.5	4.3	4.6	5.6	6.9
MWP	5.1	5.9	6.8	8.3	9.6	11.1
Sloped IPS Buoy	3.2	3.9	4.7	5.4	6.5	8.0



## 9.3 RESOURCE-COST CURVES

### 9.3.1 The Natural Resource

The Natural Resource represents the total yearly amount of wave energy in the seas around the UK. It depends on:

- The length of coastline or offshore regions exposed to waves;
- The size of the area over which the wind blows and creates waves (the fetch);
- The strength of the winds generating the waves.

The UK is geographically well situated for exploiting this resource, being surrounded by stormy waters and lying at the eastern end of a long, stormy fetch (the Atlantic Ocean), whose prevailing wind direction is from the west.

As described in Section 2.2.1, this resource was estimated in an independent study (Whittaker *et al*, 1992) and the results are shown in Table 9.3. It should be noted that the shoreline resource is based on only the most suitable sites (i.e. those with wave power levels > 20 kW/m with suitable topography and easy connection to the grid).

**Table 9.3 The UK Wave Energy Accessible Resource**

Location	Annual Energy Production (TWh)
Shoreline*	~2
Nearshore*	100 - 140
Offshore	600 - 700

Key. \* This is only for the most favourable sites.

### 9.3.2 The Technical Resource

There is potential for the development of both large- and small-scale wave energy systems in the UK. The major factors that determine the size of the amount of energy that could be produced (the Technical Resource) are:

- The distribution and magnitude of wave power levels;
- Technical limitations (the capture efficiency of the devices, their availability, etc.);
- Economic considerations (i.e. ignore areas with low wave power levels such as the eastern coast);
- Environmental considerations (e.g. a limit on the acceptable number of nearshore and shoreline devices; avoiding ecologically sensitive areas, etc.);
- Other (e.g. provision of shipping lanes, avoiding MOD testing areas, etc.).

Taking into account these technical and environmental considerations, the Technical Resource is much lower than the Accessible Resource as shown in

Table 9.4. It should be noted that the nearshore and shoreline resource is determined by the environmentally acceptable deployment of up to 200 devices. These are taken to be either OSPREYS or Limpets, which might be competing for the same locations.

**Table 9.4 The UK Wave Energy Technical Resource**

Location	Annual Energy Production (TWh)
Shoreline	0.4
Nearshore*	2.1
Offshore	50

### 9.3.3 Resource-Cost Curves

The resource-cost curve for wave energy represents the resource which could be exploited at a given cost of generation, including the technical and environmental constraints noted in the previous Section. The best sites (i.e. those with the highest wave power levels that are nearest to the grid) provide the cheapest resource and, as the characteristics of sites become less favourable, the cost of exploiting the sites' resources increases.

In order to provide an indication of the likely resource-cost curve for this technology, an assessment has been undertaken for representative devices based on the results presented in this report.

- The nearshore/shoreline resource-cost curve is for an environmentally acceptable deployment of up to 200 OSPREY wind-wave devices. The actual resource could increase if greater numbers of devices are allowed to be deployed. The generating costs of the Limpet are higher and, since it would be competing for the same resource as the OSPREY, its resource-cost curve is omitted.
- The offshore resource-cost curve is based on the Sloped IPS Buoy. This device is chosen in preference to the Duck, because the latter is a more sophisticated device that would take longer to develop and prove. Like many of the offshore technologies, the Sloped IPS buoy is at an early stage of development and so there is uncertainty associated with these predictions and the results should not be taken as definitive. They assume that the current design will function as predicted and that no increase in costs would occur as the concept progresses to a more detailed design.

It should be noted that these devices are not those predicted to produce the cheapest electricity. There are other, potentially more economic devices but there is less information available on them.

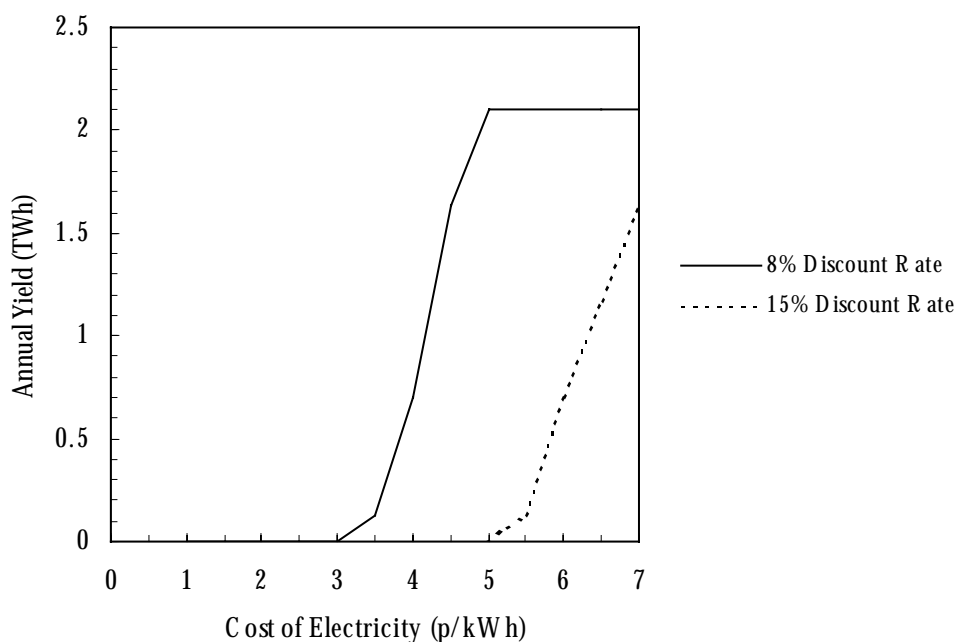
The results are shown in Figures 9.6 and 9.7. The resource shown is much less than the Technical Resource, because it represents only that part of the resource that is exploitable at 7 p/kWh or less.

## 9.4 THE COMMERCIAL STATUS OF WAVE ENERGY

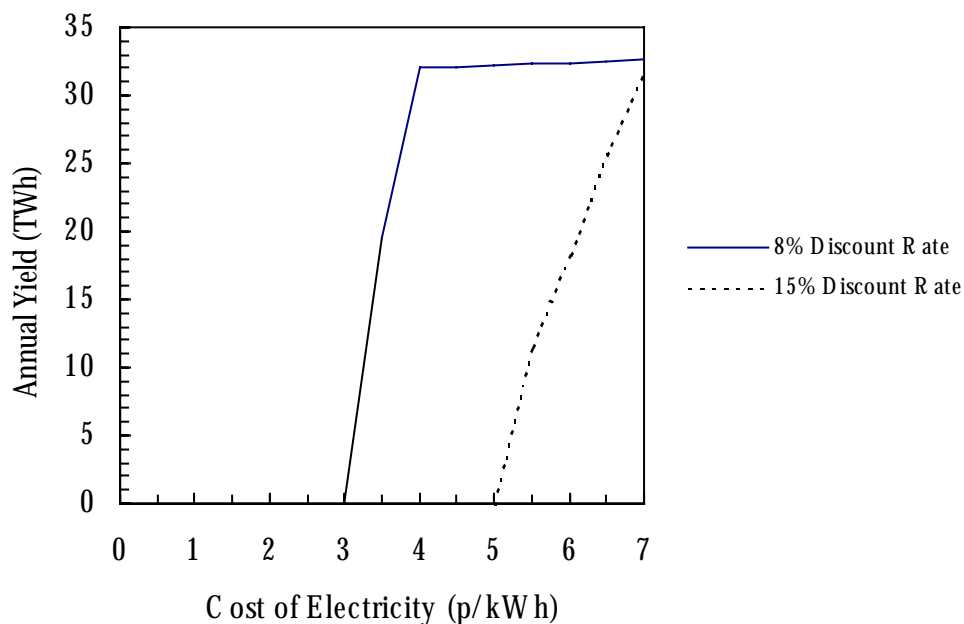
### 9.4.1 The UK Market

The extensive activities described in this review could result in the deployment of commercial-sized wave energy devices in the next few years (e.g. by 2001). Taking into account only those devices currently committed to deployment, the UK installed capacity is expected to grow to over 3 MW. In addition, wave energy has formed part of the call for the current round of the Scottish Renewables Order and so could add to this capacity with other devices not assessed in this review.

**Figure 9.6 UK Nearshore/Shoreline Wave Energy Resource Cost Curves\***



\* Applicable to 2010 and 2025.

**Figure 9.7 UK Offshore Wave Energy Resource-Cost Curves\***

\* Applicable to 2010 and 2025.

The deployment of wave energy schemes beyond this date will depend on the technical performance and reliability of these first commercial schemes. On a longer timescale (e.g. 2010 and beyond) the prospects could also be influenced by the deployment of new devices currently being researched. If wave energy devices do achieve their predicted costs and performance they could generate over 30 TWh/year in the UK. This would correspond to an investment of more than £ 10 billion.

#### 9.4.2 Export Potential

There are well advanced plans to increase the wave energy capacity in the rest of the world to nearly 6 MW in the next few years (primarily from OWCs). Further predictions for future world-wide capacity are, at present, speculative but several companies have plans for the deployment of several MWs per year in the period 2000-2005, with increasing deployment thereafter.

An evaluation of the global wave power levels carried out as part of this review indicates a resource of > 1 TW. An assessment of the likely markets was made, taking into account competing sources of electricity. This indicated that, if the wave energy devices assessed in this review performed as predicted, then their economic contribution would be > 2,000 TWh/year. This would correspond to an investment of over £ 500 billion.

Much interest has been expressed in wave energy (and other renewable energy technologies) by developing nations, as a provider of both electricity and potable water (through reverse osmosis). However, export to such markets represents a level of effort and risk that small wave energy developers cannot easily accommodate. This is a situation faced by SMEs in other areas and the methods of reducing risk available to them might be applicable to wave energy.

#### 9.4.3 Industry Status

Given the relatively immature status of wave energy, there is only a limited number of companies actively involved in this technology with wave energy forming their main product line. Taking into account only those companies with credible devices and advanced business plans, the industry comprises:

- One major UK company (Wavegen)
- About six commercial companies world-wide:
  - du Quesne Environmental (Ireland)
  - Energetech Australia Pty. Ltd.
  - Hydam Ltd. (Ireland)
  - Ocean Power Technologies, Inc. (USA)
  - Teamwork Technology (Netherlands)
  - Technocean (Sweden)
- Several Governments (e.g. Denmark, India and Japan) with significant investment in this area, including full-sized schemes.

There are several commercial consultants in this field, with at least one company in each of the countries identified above. There are also several academic consultants in this area.

#### 9.4.4 Financial Institutions

Only one UK financial institution is known to have involvement in a wave energy device. Other devices obtain financial support from a range of sources:

- Private finance;
- Shareholders;
- Other energy-related businesses (e.g. oil companies and utilities);
- Overseas Governments;
- European Commission.

## 9.5 THE PROSPECTS FOR WAVE ENERGY

### 9.5.1 Early Demonstration Schemes

With the inclusion of wave energy in the recent Scottish Renewables Order and Wavegen's plans to deploy one or more schemes in the near future, it is likely that wave energy will soon start making a modest contribution to the Government's target for renewables. However, there are significant difficulties faced by these early projects.

- **Procedures.** An extensive and expensive consultation process is needed before a nearshore or shoreline wave energy device can be deployed. This is because of a plethora of statutory bodies that have an involvement in our coastline and surrounding waters. The costs and delays involved cannot easily be accommodated by the small companies building wave energy devices. Wave energy would benefit from the streamlining of the legal and statutory requirements, rather as in Ireland, where fewer bodies and one regulatory act (the Foreshore Act) encompass nearly all the procedural steps.
- **Grid Connection.** Good locations for wave energy devices are often situated near the end of the distribution grid and any would-be developers will have to pay grid connection charges. The limited experience to date in this area indicates that such charges are very high (~ £ 1M). They represent a major cost centre that lies outside the control of the developers.
- **Design and operation.** In the absence of technology specific design codes and operating procedures, wave energy devices run the risk of being put in the same category as offshore oil production platforms (with regards to factors of safety in their design and operation). These are designed and operated with a view to their (generally) high levels of manning and the dangerous nature of the products that they handle. Therefore, the level of conservatism in design codes and health and safety procedures might not be appropriate to a wave energy device, which is unmanned most of the time and has no inflammable or explosive products.
- **Developing a home market.** The incorporation of wave energy into the Scottish Renewables Order will help to establish a home market for this technology, which is probably essential for future exports.
- **Exports.** Much interest has been expressed in wave energy devices (as well as other renewable energy technologies) by developed or developing nations. This includes using wave energy to provide both electricity and potable water (through reverse osmosis). These are two potentially large markets. However, exports to such countries involves a level of risk that small wave energy developers cannot easily take on.

Diminishing or overcoming the above difficulties will take considerable time and effort. Therefore, direct financial support may be required for the first demonstration schemes to enable them to overcome these non-technical barriers. Several companies have now obtained this support from a variety of sources (see Section 9.4.4).

### 9.5.2 The Need for Further Research in the UK

As noted in Chapter 7, wave energy is being developed in a number of countries and several schemes are already being built or are planned. This world-wide activity suggests that this renewable energy source is now viewed as being of increasing importance. This is underlined by the growing governmental and industrial interest in this area :

- The Danish Government recently announced a £ 3 million programme to develop a Danish wave energy programme.
- Major companies are interested in making wave energy commercial, as illustrated by an oil company and a venture capital firm recently taking equity in a wave energy device manufacturer.

Whilst the predicted costs of wave energy are close to being economic (Figures 9.3 and 9.4), they have been derived primarily through evaluating the designs for wave energy devices, because there are no actual schemes in the UK. Therefore, further work is needed to provide the information required to improve confidence in these predictions and to identify the best technologies to develop after the early demonstration schemes.

On the basis of the results produced in this review, the most promising second generation devices are the small, floating devices, such as those evaluated in Chapter 6. Within the UK, these are still being researched at a university level. Such research is relatively inexpensive and very cost effective. It is likely that 3 - 5 years further work is needed on the PS Frog and Sloped IPS Buoy, before they would be ready for demonstration. There are several areas common to these devices, where further R&D is required (e.g. model testing, hydrodynamics, power take-off, maintenance procedures, design standards, etc.). In addition, there are aspects of the first generation devices (OWCs) that would benefit from further R&D (e.g. power conditioning, energy storage, turbine performance, etc.).

## 9.6 ADDITIONAL CONSIDERATIONS

The Marine Technology Foresight Panel recently issued the results of a review of offshore energy (both hydrocarbons and renewables – OST, 1999). This laid out a programme for development of wave energy (*inter alia*) and made several recommendations.

## 9.7 CONCLUSION

Both this and the earlier independent evaluation of wave energy (Thorpe 1992) showed that the optimistic expectations for the original wave energy devices were unfounded. Nevertheless, the same review methodology has now indicated that wave energy could yet become a useful source of energy. The first commercial OWC schemes are expected to be deployed in the next few years, along with demonstration schemes for other technologies. However, the more promising offshore devices are still at the assessment stage.





## 10 References

- Anderson C G, (1985). "First Assessment of the Magnetic-Hydrostatic Main Bearing Proposed for the Duck Wave Energy Converter", PhD Thesis, Edinburgh University, November 1985.
- Athanassoulis, G A, *et al*, (1995). "European Wave Energy Atlas", Proceedings of the Second European Wave Power Conference, Lisbon, Portugal, 8-10 November, 1995.
- Atkins Oil & Gas Engineering Ltd, (1992), "A Parametric Costing Model for Wave Energy Technology", ETSU Report Number WV 1685.
- Bergdahl, L, (1992). "Review of Research in Sweden", Proceedings of a Workshop on *Wave Energy R&D*, Cork, Ireland, 1992.
- Bergdahl, L, *et al*, (1979). "The Swedish Wave Energy Research Programme", Proceedings of a Symposium on *Wave Energy Utilisation*, Gothenburg, Sweden, 1979.
- Bracewell, R H, (1990). "Frog and PS Frog: a Study of Two Reactionless Ocean Wave Energy Converters", PhD. Thesis, Lancaster University, September 1990.
- Bretschneider, C L, and Reid, R O, (1954). "Modification of Wave Height Due to Bottom Friction, Percolation and Refraction", Tech. Memo. Number 45, US Army Corps. of Engineers, October 1954.
- Brito-Melo, A, *et al*, (1995). "Mathematical Extrapolation of Tank Testing Results: Application to the Azores Wave Pilot Plant", Proceedings of the Second European Wave Power Conference, Lisbon, Portugal, 8-10 November, 1995.
- CEC, (1993). "Wave Energy Converters - Generic Technical Evaluation Study", a report for the Commission of the European Communities, published by Danish Wave Power aps, August 1993.
- CEGELEC, (1994). "SYNCDRIIVE. A.C. Variable Speed Drives 500 kW to 60,000 kW", from CEGELEC PROJECTS Ltd., Broughton Road, Rugby, UK, 1994.
- Collins, K J, Jensen, A C, and Lockwood, A P M, (1991). "Artificial Reef Project - Poole Bay", Progress in Underwater Science, Vol. 16, 1991, pp 75-84.
- Coventry, (1986). "The Development of the Circular SEA Clam", Coventry Polytechnic and SEA Energy Associates, ETSU Report No. WV-1676-P1, 1986.

- Curran, R, Raghunathan, S, and Whittaker, T J T, (1995). "The Influence of Flow Profile on the Islay Wells Turbine Performance", Proceedings of the Second European Wave Power Conference, Lisbon, Portugal, 8-10 November, 1995.
- Darbyshire, M, and Draper, L, (1963). "Forecasting Wind Generated Sea Waves", Engineering, pp 482-484, 1963.
- DTI, (1994). "Energy Paper 61 - Energy Technologies for the UK", HMSO, London.
- DWP, (1996). "Hanstholm Phase 2B. Offshore Energy Test 1994-1996", Danish Wave Power, Copenhagen, Denmark.
- Edinburgh, (1979). "Wave Energy - Salter's Duck Fifth Year Report", Edinburgh Wave Power Project, ETSU Report Number WV 1512, Parts 4A-4C, November 1979.
- Environment & Resource Technology Ltd, 1994. "Environmental Assessment of the Proposed OSPREY Wave Energy Device for Dounreay, Caithness", Report No. 93/060/R1, January 1994.
- ETSU, (1994). "An Assessment of Renewable Energy for the UK", Report R-82, ETSU, 1994.
- ETSU, (1985). "The Department of Energy's R&D Programme 1974-1983", ETSU Report R-26, March 1985.
- Eurowave, (1997). "Developments of Wave Power - the Energy Source for the Future", Company Presentation, December, 1997.
- Eyre, N, (1995). "Externalities of Energy, 'Externe' Project. Volume 6 - Wind and Hydro", Part 1 Wind, pp 1-21, European Commission, DGXII, Science, Research and Development, JOULE, Report No. EUR 16525 EN.
- Falcão, A F de O, Whittaker, T J T, and Lewis, A W, (1993). "JOULE II Preliminary Action: European Pilot Plant Study", Proceedings of the First European Wave Power Conference, Edinburgh, UK, 21-24 July, 1993.
- Falcão, A F de O *et al*, (1995). "Design of a Shoreline Wave Power Pilot Plant for the Island of Pico, Azores", Proceedings of the Second European Wave Power Conference, Lisbon, Portugal, 8-10 November, 1995.
- French, M J, (1991). "PS Frog Mk 2: a Promising Design of Wave Energy Converter", paper submitted to the Wave Energy Steering Committee, 23 August, 1991.
- Folley, M S, (1991). "The Design of Point Absorbing Wave Energy Converters", PhD Thesis, Lancaster University, September 1991.
- GES, (1984). "Vågkraftverk - 64 MW Bremanger, Norge", Götaverken Energy Systems Report Number NB64-K 184/1, 1984.

- Hasselmann, K, et al, (1976). "Parametric Wave Prediction Model", *Journal Physical Oceanography*, Vol. 6, 1976.
- Holmes, B, *et al*, (1995). "1:25 Scale Testing of the Azores Pilot Plant", *Proceedings of the Second European Wave Power Conference*, Lisbon, Portugal, 8-10 November, 1995.
- Hotta, H, (1995). "R&D on Wave Power in Japan", *Proceedings of the Second European Wave Power Conference*, Lisbon, Portugal, 8-10 November, 1995.
- Hotta, H, *et al*, (1995). "On the Open Sea Testing of a Prototype Device of a Floating Wave Power Device: Mighty Whale", *Proceedings of the Second European Wave Power Conference*, Lisbon, Portugal, 8-10 November, 1995.
- Hunter, R, (1991). "Future Possibilities for the NEL Oscillating Water Column Wave Energy Converter", *Proceedings of a Colloquium on Wave Energy*, Institution of Mechanical Engineers, London, UK, 28 November, 1991.
- Kofoed, J P, *et al*, (1998). "Wave Dragon – a Slack Moored Wave Energy Converter", *Third European Wave Energy Conference*, Patras, Greece, September 1998.
- Lancaster University, (1986). "Design Study with Experimental Support on a Reactionless Wave Energy Converter Buoy", *ETSU Report Number WV 1672-P2*, January 1986.
- Lancaster University, (1988). "Design Study of the Engineering of a Reactionless Wave Energy Converter Buoy Working in Pitch and Surge (PS Frog)", *ETSU Report on Contract Number E/5A/CON/1681/1852*.
- Legerton, M. (1997). "A Review of the Prospects for Offshore Wind Energy in the UK", paper presented to the UK Wind Energy Advisory Committee.
- Lockett, F P, (1991). "The CLAM Wave Energy Converter", *I. Mech. E. Seminar on Wave Energy*, 28 November 1991.
- Matas, A, (1992). "Project OLAS-2000 Wave Energy in Spain", *Proceedings of a workshop on Wave Energy R&D*, Cork, Ireland, 1-2 October, 1992.
- McAlpine, (1981). "Final Report on the Optimisation of the Bristol Submerged Cylinder Wave Energy Device", Sir Robert McAlpine & Sons Ltd., *ETSU Report Number WV 1630 Parts 3a to 3c*, December 1981.
- McAlpine, (1982). "Supplementary Report on the Optimisation of the Bristol Submerged Cylinder Wave Energy Device", Sir Robert McAlpine & Sons Ltd., *ETSU Report Number WV 1630-P5*, December 1982.
- McCormick, M E, *et al*, (1998). "Potable Water and Electricity Production by a Hinged-Barge Wave Energy Conversion System", paper provided by R P McCabe, 1998.

- McCormick, M E, and Murtagh, J, (1992). “Large-Scale Experimental Study of the McCabe Wave Pump”, Report No. EW-03-92, US Naval Academy, Division of Engineering and Weapons, Annapolis, Maryland, January 1992.
- Mitsuyasu, H, *et al*, (1964). “Observations of the Directional Spectrum using a Cloverleaf Buoy”, *Journal Physical Oceanography*, Vol. 5, pp 750-760, 1964.
- Miyazaki, T, (1995). “Japanese Wave Energy Devices”, *Proceedings of the Second European Wave Power Conference*, Lisbon, Portugal, 8-10 November, 1995.
- Nielsen, K *et al*, (1995). “Hanstholm Offshore Wave Energy Experiment”, *Proceedings of the Second European Wave Power Conference*, Lisbon, Portugal, 8-10 November, 1995.
- Nichols, N K, *et al*, (1991). “Optimal Phase Control of Wave Power Devices”, *Proceedings of a Seminar on Wave Energy*, Institute of Mechanical Engineers, London, UK, 28th November 1991.
- Osanai, S, *et al*, (1995). “Feasibility Tests of New Pendular Type Wave Energy Conversion System”, *Proceedings of the Second European Wave Power Conference*, Lisbon, Portugal, 8-10 November, 1995.
- Peatfield, A M, (1991). “The Economic Viability of the Circular Clam for Offshore Wave Energy Utilisation”, *I. Mech. E. Seminar on Wave Energy*, 28 November 1991.
- OST, (1999). “Energies from the Sea – Towards 2020. A Marine Foresight Panel Report” April 1999, Office of Science and Technology, DTI, UK, 1999.
- Pierson W J, and Moskowitz, L, (1964). “A Proposed Spectral Form for Fully Developed Sea based on the Similarity Theory of S. A. Kitaigorodskii”, *J. Geophys. Research*, Volume 69(24), 1964, pp 5181-5190.
- Pontes, M T, *et al*, (1995). “European Atlas of the Wave Energy Resource”, *Proceedings of the Second European Wave Power Conference*, Lisbon, Portugal, 8-10 November, 1995.
- Probert, P K, and Mitchell, R, (1979). “Nature Implications of Siting of Wave Energy Converters off the Outer Hebrides”, Report No. 15, Nature Conservancy Council, 1979.
- Probert, P K, and Mitchell, R, (1983). “Environmental Implications of Wave Energy for the Outer Hebrides and Moray Firth”, *Ocean Engineering*, Vol. 10, 1983, No , pp 459-469.
- QUB, 1992. “The UK's Shoreline and Nearshore Wave Energy Resource”, The Queen's University of Belfast, ETSU Report WV 1683, 1992.
- Rampen, W H S, *et al*, (1995). “Progress on the Development of the Wedding-Cake Digital Hydraulic Pump Motor”, *Proceedings of the Second European Wave Energy Conference*, Lisbon, Portugal, 8-10 November 1995.

Ravindran, M, *et al*, (1995). “Indian Wave Energy Programme: Progress and Future Plans”, Proceedings of the Second European Wave Power Conference, Lisbon, Portugal, 8-10 November, 1995.

Rebollo, L, *et al*, (1995). “Project OLAS-1000 Experiences, Modelling and Results”, Proceedings of the Second European Wave Power Conference, Lisbon, Portugal, 8-10 November, 1995.

Russell, A and Diamantaras, K, (1995). “The European Commission Wave Energy R&D Programme”, Proceedings of the Second European Wave Power Conference, Lisbon, Portugal, 8-10 November, 1995.

Salter, S, (1993). “Changes to the 1981 Design of Spine-based Ducks”, Proceedings of the First European Wave Power Conference, Edinburgh, UK, 21-24 July, 1993.

Salter S H, and Rampen, W H S, (1993). “The Wedding Cake Multi Eccentric Radial Piston Hydraulic Machine with Direct Computer Control of Displacement”, pp 47-64, Proceedings of *10th International Conference on Fluid Power*, Brugge, Holland, April 1993.

Salter, S, and Lin, C-P, (1995). “The Sloped IPS Wave Energy Converter”, Proceedings of the Second European Wave Power Conference, Lisbon, Portugal, 8-10 November, 1995.

Salter, S, and Taylor, J, (1995). “The Design of a High Speed Stop Valve for Oscillating Water Columns”, Proceedings of the Second European Wave Power Conference, Lisbon, Portugal, 8-10 November, 1995.

Salter, S, (1996). “Replies to Questions on Wave Energy”, European Commission - DG XVII Small Hydro Meeting, 4th September, 1996.

Shawater, (1992). “Bristol Cylinder Wave Energy Device; Consultancy to Review of Wave Energy”, Shawater Ltd., ETSU Report Number WV 1692, 1992.

Southgate, H N, (1981). “Ray Methods for Combined Refraction and Diffraction Problems”, Report Number IT 214, Hydraulics Research, Wallingford, Oxon. UK.

Southgate, 1987. “Wave Prediction in Deep Water and at the Coastline”, Report Number SR 114, Hydraulics Research, Wallingford, Oxfordshire, UK.

Taylor, J R M, and Salter, S, (1995). “Design and Testing of a Plano-Convex Bearing from a Variable Pitch Turbine”, Proceedings of the Second European Wave Power Conference, Lisbon, Portugal, 8-10 November, 1995.

Thorpe, T W, (1992). “A Review of Wave Energy”, Vols. 1 and 2, ETSU Report Number R-72, December 1992.

- Thorpe, T W, and Picken, M J, (1993). "Wave Energy Devices and the Marine Environment", IEE Proceedings-A, Vol. 140, Number 1, p. 63-70, January 1993.
- Thorpe, T W, (1993a). "Methodology for Reliability and Economic Assessment", in *Wave Energy Converters: Generic Technical Evaluation Study*, Danish Wave Power, 1993.
- Thorpe, T W, (1993b). "A Methodology for Reliability, Economic and Environmental Assessment of Wave Energy", Proceedings of the 1993 European Wave Energy Symposium, Edinburgh, Scotland, 21-24 July 1993.
- Thorpe, T W, (1995). "An Assessment of the ART OSPREY Wave Energy Device", ETSU Report Number R-90, October 1995.
- Thorpe, T W, (1998a). "An Overview of Wave Energy Technologies", AEAT-3615 for the Marine Foresight Panel, May 1998.
- Thorpe, T W, (1998b). "Wave Energy Potential in the UK", Report Number AEAT-3028 for the DTI, February 1998.
- Tjungen, K J, (1995). "TAPCHAN Ocean Wave Energy Project at Java, Updated Project Status", Proceedings of the Second European Wave Power Conference, Lisbon, Portugal, 8-10 November, 1995.
- Todd, C D, Bentley, M G, and Kinnear, J, (1992). "Torness Artificial Reef Project", Proceedings of the 1st British Conference on Artificial Reefs and Restocking", Stromness, Orkney Islands, Scotland, 12 September 1992.
- Watabe, T *et al*, (1995). "New Pendulor and Its Field Test", Proceedings of the Second European Wave Power Conference, Lisbon, Portugal, 8-10 November, 1995.
- Weggel, J R, (1972). "Maximum Breaker Height", Journal of Waterways, Harbours and Coastal Engineering Division", Vol. 98, November 1972
- Whittaker, T J, *et al*, 1992a. "The Islay Shoreline Wave Energy Device - Phase 3" Report WV 1682, ETSU, 1992.
- Whittaker, T J T, *et al*, 1992b. "The UK's Shoreline and Nearshore Wave Energy Resource", Report WV 1683, ETSU, 1992.
- Whittaker, T J T and Raghunathan, S, (1993). "Islay European Shoreline Wave Power Station", Proceedings of the First European Wave Energy Symposium, Edinburgh, 21-24 July, 1993.
- Whittaker, T J T, and Stewart, T P, (1993). "An Experimental Study of Nearshore and Shoreline Oscillating Water Columns with Harbours", Proceedings of the First European Wave Power Conference, Edinburgh, UK, 21-24 July, 1993.

Whittaker, T J T, *et al*, (1995a). “Implications of Operational Experiences of the Islay OWC for the design of Wells Turbines”, Proceedings of the Second European Wave Power Conference, Lisbon, Portugal, 8-10 November, 1995.

Whittaker, T J T, *et al*, (1995b). “Islay European Shoreline Wave Power Plant, the Design of a Modular System”, Proceedings of the Second European Wave Power Conference, Lisbon, Portugal, 8-10 November, 1995.

Whittaker, T J T, (1997). “Islay LIMPET Wave Power Plant”, private communication.

White, P, (1989). “Developments in Norwegian Wave Energy”, Proceedings of a Conference on *Wave Energy Devices*, Coventry, UK.

Winter, A J B, (1979). “Some Calculations from the Met. Office Model”, Report to Wave Energy Steering Committee, WESC(79) DA84, July 1979.

Zhi, Y, *et al*, (1995). “Power Output of an Onshore OWC Wave Power Station at Dawanshan Island”, Proceedings of the Second European Wave Power Conference, Lisbon, Portugal, 8-10 November, 1995.