

Submitted to:

Cathryn Hooper
The Crown Estates Office
16 Carlton House Terrace
London
SW1Y 5AH

Tel: +44 (0)20 7210 4377
Fax: +44 (0)20 7839 7847

email: cathryn.hooper@crownestate.co.uk

Submitted by:

Jeremy Nedwell
Subacoustech Ltd
Chase Mill
Winchester Road
Bishops Waltham
Southampton
Hants SO32 1AH

Tel: +44 (0)1489 891849
Fax: +44 (0)8700 513060

email: subacoustech@subacoustech.com
website: www.subacoustech.com

Assessment of sub-sea acoustic noise and vibration from offshore wind turbines and its impact on marine wildlife; initial measurements of underwater noise during construction of offshore windfarms, and comparison with background noise

Report No. 544 R 0424

by

Dr J. Nedwell, Mr J. Langworthy & Mr D. Howell

May 2003

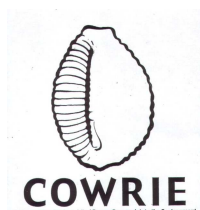

This report has been commissioned by COWRIE

Approved for release:

A handwritten signature in black ink, which appears to be 'J. Nedwell', is written over a horizontal line.

The reader should note that this report is a controlled document. Appendix E lists the version number, record of changes, referencing information, abstract and other documentation details.

CONTENTS

1	INTRODUCTION.....	1
2	THE AIMS AND OBJECTIVES OF THE RESEARCH PROGRAMME.....	1
3	THE METHODOLOGY UNDERLYING THE MEASUREMENTS TAKEN	1
3.1	INTRODUCTION.....	1
3.2	AREAS WHERE INFORMATION IS REQUIRED.....	1
3.3	RANGES OF EFFECT OF UNDERWATER NOISE.....	1
3.4	TERTIARY EFFECTS AND PERCEPTION UNITS; THE dB_{HT} (<i>SPECIES</i>).....	1
3.5	SHOALS: TYPICAL WINDFARM LOCATIONS.....	1
3.6	THE NEED FOR MEAN AND STATISTICAL DESCRIPTIONS OF NOISE.....	1
3.7	POSSIBLE MEASUREMENT STRATEGIES.....	1
3.7.1	<i>Fixed position monitoring.....</i>	<i>1</i>
3.7.2	<i>Assessing spatial and temporal variability: transects.....</i>	<i>1</i>
4	INSTRUMENTATION AND EXPERIMENTAL PROTOCOL	1
4.1	FACTORS LIMITING THE MEASUREMENTS	1
4.2	DESCRIPTION OF THE TYPES OF NOISE MEASURED.....	1
4.3	THE TRANSECTS USED FOR MEASUREMENTS.....	1
4.3.1	<i>North Hoyle.....</i>	<i>1</i>
4.3.2	<i>Scroby Sands.....</i>	<i>1</i>
4.4	INSTRUMENTATION AND MEASUREMENT PROCEDURE.....	1
4.5	THE PROCESSING OF MEASUREMENTS	1
4.5.1	<i>General processing.....</i>	<i>1</i>
4.5.2	<i>Processing environment and quality checks.....</i>	<i>1</i>
5	BACKGROUND NOISE MEASUREMENTS	1
5.1	BACKGROUND NOISE IN CONVENTIONAL UNITS	1
5.2	BACKGROUND NOISE IN dB_{HT} UNITS.....	1
5.3	NORTH HOYLE: NOISE FROM THE DOUGLAS PLATFORM	1
6	CONSTRUCTION NOISE MEASUREMENTS.....	1
6.1	PILING AT NORTH HOYLE.....	1
6.1.1	<i>Measurements of piling at North Hoyle, conventional units.....</i>	<i>1</i>
6.1.2	<i>Measurements of piling at North Hoyle, dB_{HT} units.....</i>	<i>1</i>
6.1.3	<i>Measurements of piling at North Hoyle; possible physical effects of piling noise on fish.....</i>	<i>1</i>
6.2	IMPACT PILE DRIVING AT SCROBY SANDS	1
6.3	CABLE TRENCHING AT NORTH HOYLE	1
6.4	ROCK SOCKET DRILLING NOISE AT NORTH HOYLE.....	1
7	MITIGATION MEASURES FOR PILING.	1
7.1	HOW PILING CREATES NOISE.....	1
7.2	QUANTIFICATION OF LIKELY EFFECTS.....	1
7.3	MITIGATION MEASURES	1
7.3.1	<i>Control at source.....</i>	<i>1</i>
7.3.2	<i>Non-engineering methods.....</i>	<i>1</i>
7.3.3	<i>Monitoring.....</i>	<i>1</i>
8	SUMMARY AND CONCLUSIONS.....	1
9	REFERENCES.....	1
10	APPENDIX A - MEASURING NOISE	1
11	APPENDIX B - DETAILS OF INSTRUMENTATION AND MEASUREMENT TECHNIQUES	1
12	APPENDIX C - DESCRIPTION OF WINDFARM-RELATED NOISE SOURCES.....	1
13	APPENDIX D - CALIBRATION CHARTS.....	1
14	APPENDIX E - RECORD OF CHANGES.....	1

Executive summary

The United Kingdom government's renewable energy strategy has a target of providing 10% of the UK's electricity from renewable sources by 2010, and 15% by 2015. A significant expansion of offshore wind energy is an important component of this strategy. The UK's first large-scale offshore wind farm, at North Hoyle in Wales, was commissioned in November 2003, and a second development at Scroby Sands is nearing completion. Further major developments are planned at the Thames Estuary, the Greater Wash and in the North West.

The wind energy industry has concerns as to whether underwater noise during the construction and operation of windfarms might have the capacity to cause environmental effects, such as avoidance by marine mammals and fish. Since these effects of underwater noise are not yet fully understood, the Collaborative for Offshore Wind Research Into the Environment (COWRIE) instructed Subacoustech Ltd (*via* the offices of The Crown Estate) to investigate these matters.

The purposes of the investigation reported herein was to provide measurements which would:

1. evaluate the pre-existing background noise environment;
2. measure and interpret the underwater noise from construction and operation of windfarms, and thus to
3. interpret these measurements in terms of any potential for environmental effect, and thus to
4. provide information allowing the wind energy industry to minimise any impact of noise during the lifecycle (construction, operation and decommissioning) of windfarms.

The report presents a significant body of underwater noise measurements taken in the period April 2003 to January 2004 at operational and construction stage windfarm sites in the UK. A detailed analysis of the measurements has been made which indicates the spatial, temporal and statistical properties of the noise. An estimation of the likely behavioural and physical effects on a selection of the most common species of fish and marine mammals is also presented using both conventional analysis and the dB_{ht} (*species*) scale.

The measurements showed:

1. that the levels of background noise at typical windfarm sites are towards the upper bound of typical deep water background noise levels. The overall sound pressure level varies significantly more during the daytime than at other times of day, due to the higher number of short local ship movements. The noise levels are higher at low wind speeds, contrary to the normal assumption that they will rise with increasing wind speed. At North Hoyle pre-existing man-made noise is probably a significant contributor to the background noise level;
2. that piling at North Hoyle gave a Source Level of 260 dB re 1 μPa @ 1 metre for 5 m (metres) depth, and 262 dB re 1 μPa @ 1 m at 10 m depth, associated with a Transmission Loss given by $22 \log(R)$, where R is the range. Calculations using the dB_{ht} scale levels indicate that strong avoidance reaction by a range of species would be likely at ranges of up to several kilometres. The levels of sound recorded during piling are such that within perhaps a hundred metres they could cause injury. Measurements of piling at Scroby Sands were similar in level to those at North Hoyle, and similar conclusions pertain in respect of possible environmental effects;
3. that cable trenching at North Hoyle gave a Source Level of 178 dB re 1 μPa @ 1 m if a Transmission Loss of $22 \log(R)$ is assumed;

4. that rock socket drilling produced a strong fundamental component at 125 Hz, and harmonics up to 1 kHz, but it was not possible to establish the Source Level and Transmission Loss. Tonal components of the drilling could, however, be identified at ranges of up to 7 km.

It is recommended that piling in particular should be regarded as capable of causing environmental effects, and planning of piling operations should take account of the effects of its noise on sensitive species.

Mitigation measures that may be used to reduce the impact of piling are discussed.

1 Introduction

The UK government's renewable energy strategy requires that 10% of the UK's energy should be generated from renewable sources by 2010, and 15% by 2015. Offshore windfarms represent a key component in this strategy. There are currently two operational large scale windfarms, which gained planning consent in the first round of UK offshore wind developments. Construction began in April 2003 of the UK's first large scale offshore wind farm at North Hoyle, which is 5 miles off the North Wales coast between Rhyl and Prestatyn. The site comprises 30 wind turbines rated at 2 MW (Megawatts). Scroby Sands, situated 2 miles off the coast of Great Yarmouth, is owned by Powergen Offshore Renewables, and when complete in the latter part of 2004 will also comprise 30 wind turbines of 2MW.

A further fifteen projects, representing between 5.4 and 7.2 GW (Gigawatts) of new wind capacity, have been licensed in the second round and will provide power equivalent to 4 million homes, or one in six of UK households. The sites will be built in three strategic areas of shallow sea: the Thames Estuary; Greater Wash; and the North West. Of the 15 wind farms three are fully outside territorial waters, and include the world's largest proposed offshore wind farm, in the Greater Wash area, which will provide up to 1.2 GW of generating capacity.

The wind energy industry recognises that there are concerns over whether underwater noise caused by the construction and operation of windfarms might have the capacity to cause environmental effects. Underwater noise from other offshore activities, such as seismic surveying, has been cited as having the capacity to cause behaviour changes, such as avoidance by marine mammals and fish (Richardson (1995), Turnpenny and Nedwell (1994)). Other quoted effects of noise include impeded communication amongst groups of animals, animals being driven away from feeding or breeding grounds, or their deflection from migration routes. At sufficiently high levels of exposure to sound, for instance during underwater explosive blast, physical injury, such as deafness, may also occur.

Since the levels of underwater noise created during windfarm construction and operation is not well established, and hence its effects are not fully understood, the Collaborative for Offshore Wind Research Into the Environment (COWRIE) has taken an initiative to provide information in this area. The Crown Estates, on behalf of COWRIE, contracted Subacoustech Ltd to investigate these matters on their behalf.

This report presents the analysis and interpretation of a significant body of underwater noise measurements taken in the period April 2003 to January 2004. The research commenced with baseline measurements of the pre-existing level of background noise at typical offshore windfarm sites in the UK, and progressed to measurements of noise from a wide variety of sources during the construction of offshore windfarms. A detailed analysis of the measurements has been made which indicates the spatial, temporal and statistical properties of the noise, and evaluates construction noise in terms of its potential for environmental effect. An estimation of the likely behavioural and physical effects on a selection of common species of fish and marine mammals has been made using both conventional analysis and the dB_{ht} (*species*) scale.

The results of this analysis provide an initial evaluation of the significance of offshore windfarm construction noise, and rank-ordering of various sources of noise that are created during construction. This information will aid the minimisation of the effects of such noise during future offshore windfarm construction projects.

Further measurements that will be taken during 2004 and 2005 will document the typical levels of noise resulting from windfarm operation, and will enable the significance of underwater noise during the windfarm lifecycle of construction, operation and decommissioning to be evaluated.

2 The aims and objectives of the research programme

The objectives of the programme of research under which this report has been produced are as follows:

- to identify marine mammal species and other marine organisms that may use coastal areas, and to determine their sensitivity to noise;
- to characterise the noise spectrum and level of underwater noise created during the construction, operation and decommissioning of windfarms;
- hence to determine the effects that noise and vibration may have on these species, and the duration of such effects.

This report presents a significant body of underwater noise measurements taken in the first phase of the programme, during the period April 2003 to January 2004, at operational and construction stage windfarm sites in the UK. The aims during this phase of measurements were:

- to evaluate the pre-existing background noise environment at typical windfarm site locations;
- to measure and interpret the underwater noise from construction and operation of windfarms, using both conventional analysis and the dB_{ht} (*species*) scale, and to interpret these measurements in terms of any potential for environmental effect, and
- to draw general and specific conclusions, and thus to provide a rapid feedback of information allowing the wind energy industry, if required, to modify or mitigate construction or operation methods.

3 The methodology underlying the measurements taken

3.1 Introduction

Matters that have had to be considered when designing the programme of measurements have included:

- the areas in which there is a lack of knowledge, and consequently which must be investigated;
- the type of effect that the sound may cause, and hence the way in which the sound must be measured and the units in which it must be analysed;
- the means of recording and generalising the results, so that they might be used in future impact assessments;
- the location of the measurements, and any influence that typical windfarm locations might have on usual measurement techniques;
- the variability of the noise, and hence the importance of statistical descriptors of the noise;
- the importance of describing spatial and temporal distributions of sound, and hence whether single point monitoring (giving good information about variations with time, but only at one point) or transect monitoring (giving good information about variations with distance, but at only one period) is appropriate.

It may be noted that vibration, for instance of the seabed in the vicinity of the windfarm, has additionally been cited as a possible cause of environmental effects. It is difficult to directly measure vibration in soft sediments, but it may be inferred from measurements of pressure.

3.2 Areas where information is required

There are three phases in the lifecycle of an offshore windfarm, *viz.* construction, operation and decommissioning. During each of these phases underwater noise may result from a variety of sources. The construction and decommissioning phases are of much shorter duration than the operational phase, and hence the significance of any effect of noise during these periods would have to be judged against the shorter period for which the noise will be present.

During construction noise may arise from pre-installation activities, such as surveying, from increases in construction traffic, such as supply and work boats, and from engineering activity, such as piling, dredging, trenching and drilling. During operation noise may arise from a variety of sources, including aerodynamic blade noise, gearbox meshing noise and noise from other machinery. Decommissioning may involve hydraulic casing cutting, abrasive jet cutting or the use of cutting charges.

At the commencement of the present project a review of the literature by Nedwell and Howell (2004) indicated that, while some limited studies had been conducted, there was no significant body of information available on noise and its effects in respect of offshore windfarms. The initial aim of the project was therefore to measure as wide a range of noise sources as possible, in order that these could be rank-ordered in terms of their potential to cause an effect. However, effort was concentrated on measurements and interpretation of piling noise, since this was a source which was known to be capable of generating high levels of noise (Abbott (2001), Nedwell (2003)).

It has been noted that there is little information regarding background noise in shallow water environments. It was therefore also thought important in the initial stages of noise measurements to identify whether the characteristics of the underwater noise were the same as for deep water. It may be noted that background noise subsumes two further classes of noise:

man-made background noise, which includes, for instance, pre-existing noise caused by distant shipping¹; and ambient noise, which is natural noise caused by natural processes such as wind and wave noise and biological noise.

3.3 Ranges of effect of underwater noise

This section briefly discusses the quantities that are used to measure noise and the effects it may have, ways of expressing the level of noise generated by a source and the rate at which it decays with distance, and models that may be used to estimate this. Further information may be found in Appendix A.

Units of measurement. The units in which noise is measured depends on the category of effect that is of interest.

Primary effects, and secondary effects with the exception of auditory injury, are most commonly encountered with impulsive noise such as blast, and have been found by authors such as Yelverton (1972) to be associated with the *impulse*, I , or integral of pressure over time, given by

$$I = \int_0^{\infty} P(t) dt$$

where I is the impulse in Pascal-seconds (Pa.s), $P(t)$ is the acoustic pressure in Pa of the sound wave at time t , and t is time. It is unfortunate that the term “an impulse” is also used to describe a sound of short duration, but both terms are common in the literature. For this reason the term “impulsive noise” will be used in this report to describe pressure events of short duration.

The impulse may be thought of as the average pressure of the impulsive noise, multiplied by its duration. The reason for the use of impulse is that the degree of injury following exposure to underwater blast is usually related to not only its pressure but also its duration. Sometimes criteria for the primary and secondary effects of blast also specify a peak pressure at which injury will occur irrespective of the impulse, as for instance suggested by Christian (1973).

The deciBel scale. It is usual to express noise, whatever the unit of measurement, in terms of deciBels (dB). The deciBel relates the measurement of noise to a reference unit; it expresses the ratio between the measurement and the reference unit logarithmically. The term “level” is applied to any unit expressed using the deciBel scale. For a sound of peak pressure P_m Pa the Sound Pressure Level (SPL) in deciBels will be given by

$$SPL = 20 \log_{10}(P_m/P_{ref})$$

where P_{ref} is the reference pressure, which for underwater applications is usually taken as 1 microPascal (μ Pa). For instance, a blast wave of 1 bar (10^5 Pa) would have a sound pressure level, referred to 1 μ Pa, of

$$SPL = 20 \log_{10}(10^5/10^{-6}) = 220 \text{ dB re } 1 \mu\text{Pa}.$$

Note that the reference unit must be specified when quoting a level; it is common to append the unit as in the example, or to specify the default reference unit within a report. All measurements presented in this report, unless it is otherwise indicated, are referred to 1 μ Pa.

¹ Another term which is often used to describe man-made noise is “anthropogenic noise”. Strictly, the term “anthropogenic” relates to the study of the origins and development of humans, and there is doubt as to whether it is appropriate for describing man-made noise. On the grounds of simplicity the term “man-made noise” has been used herein; nevertheless, “anthropogenic noise” is a term which will be found in much literature concerning man-made noise.

Types of effect. Underwater noise can have a severe effect in the immediate vicinity of high level sources. As the distance from the source increases the noise will decrease and its effects will diminish. The effects of the noise can include:

- **primary effects**, such as immediate or delayed fatal injury of animals near to powerful sources, such as the blast from explosives underwater;
- **secondary effects**, such as injury or deafness, which may have long-term implications for survival, and
- **tertiary (behavioural) effects**, such as avoidance of the area, which may have significant effects where the man-made noise source is in the vicinity of breeding grounds, migratory routes or schooling areas.

Primary effects. Underwater noise emissions can cause fish injuries, although these normally occur only at high sound pressure levels. Such injuries are known as ‘barotraumas’. Typical effects of rapid pressure change include over-expansion and rupture of the swimbladder and formation of gas embolisms in the bloodstream, especially in the eyes (Turnpenny & Nedwell, (1994)). Eye injuries are often seen as haemorrhages or protrusions of the eye caused by gas release. The interfaces between body tissues and gas cavities such as the swimbladder can be sites for cavitation damage during the passage of pressure waves, and tissues here are vulnerable to breakdown. Repeated exposure, e.g. from driving large piles in close proximity, can lead to damage to the internal tissues.

There is no information directly concerning injury to marine mammals caused by impulsive noise, such as during piling, but information from underwater blast may be sufficient to provide a first-order estimate of its effects. Hill (1978) provides a useful review dealing with the mechanisms and sites of explosion damage in submerged land mammals and showing, in contrast, the relative resilience of marine mammals, owing to specialised adaptations to diving. These include, for example, strengthened lungs and air passages in seals and mechanisms to equalise the pressure in air spaces in the head and lungs with that of the surrounding water.

For predicting lethal range, the Yelverton *et al.* (1973) model has been widely used for marine mammals. The critical impulse levels given by Yelverton are quoted in Table 1. It should be noted that the observations were made on submerged terrestrial animals (sheep, dogs, monkeys) weighing between 5 kg and 40 kg. Hill (1978) suggested that these could yield overestimates, owing to the adaptations to pressure change of diving mammals, and increased thickness of the body wall.

Table 1. Summary of effects of different impulses on mammals diving beneath the water surface (from Yelverton *et al.*, (1972)).

Impulse (dB re 1 µPa.s)	Impulse (Pa.s)	Impulse (bar.msec)	Likely effects
169	276	2.76	No mortality. High incidence of moderately severe blast injuries, including eardrum rupture. Animals should recover on their own.
163	138	1.38	High incidence of slight blast injuries, including eardrum rupture. Animals should recover on their own.
157	69	0.69	Low incidence of trivial blast injuries. No eardrum ruptures.
151	34	0.34	Safe level. No injuries.

However, due to the relatively small areas affected, the likelihood of primary or secondary injury of marine animals occurring is low, although there may be a significant risk with sources of sound having a high level or where there is a high density of individuals (as in the case of fish shoals). Behavioural effects occur at a much lower level, and hence tend to have effects on larger numbers of animals at much greater ranges. They are consequently probably of the greatest significance in the context of the possible effects of noise from windfarm construction and operation.

3.4 Tertiary effects and perception units; the dB_{ht} (*species*).

A major thrust in the measurements has been to provide the “perceived levels” for various species, i.e. the dB_{ht} (*species*) levels, which are suitable for investigating and analysing the behavioural effects of underwater noise. Some description of this quantity is warranted here as it is a relatively new concept.

Since the tertiary effects of noise, and also auditory damage, are related to the perception of noise by a species, any scale for evaluating its effects must incorporate the hearing ability of the given species. For this reason simple measures of noise, such as its peak pressure, are inadequate to specify its likely effect on a range of species. Concerns over the environmental effects of offshore seismic shooting using airguns prompted one of the authors in 1995 to propose a perception scale for the evaluation of behavioural effects for a wide range of species; the approach was subsequently extended and formalised as the dB_{ht} (*species*) scale by Nedwell (1998a).

Levels of sound in excess of 200 dB re 1 μPa may be recorded underwater during civil engineering activities; this corresponds to levels in excess of 170 dB re 20 μPa in the units that are conventionally used in air. Such levels are encountered in air close to, for instance, airliners on takeoff, and hence environmentalists and lay members of the public are often surprised or dismayed by the levels of sound recorded. Sometimes the different physical properties of air and water are used to explain the differences, but interpretation of the significance of these levels lies in the great difference in sensitivity to sound of marine and terrestrial animals. Many marine mammals and fish are adapted for living in the noisy underwater environment, and have hearing thresholds (sensitivities of hearing) 100 dB, or 10^5 times, higher than humans, i.e. their hearing is 10^5 times less sensitive. For this reason they are able to tolerate much higher levels of noise.

The human ear is most sensitive to sound at frequencies of the order of 1 to 4 kHz, and hence these frequencies are of greatest importance in determining the physical and psychological effects of sound for humans. At lower or higher frequencies the ear is much less sensitive, and humans are hence more tolerant of these frequencies. To reflect the importance of this effect a scale of sound, the dB(A), has been developed which allows for the frequency response of the human ear. In order to estimate the physical and subjective effects of sound using this scale the sound signal is first weighted by being passed through a filter which approximately mimics the effectiveness of human hearing. The sound is measured after undergoing this process; the resulting sound level is expressed in decibels as 20 times the ratio of its RMS or peak pressure to a reference pressure. The levels at low (<100 Hz) and high (>10 kHz) frequencies, to which the human ear is insensitive, are reduced, and frequencies at the peak sensitivity of hearing (at 1 – 4 kHz) are weighted little or not at all. The level of sound that results may be considered to be related to the *perception* of the sound.

This approach has now been further extended to provide a generic model which enables better estimates of the effects of sound on marine species to be made, and allows biologically significant features of the sound to be identified.

The hearing sensitivity of a species is best described by its *audiogram*, which is a measure of the lowest level, or threshold, of sound that the species can hear; it is usually presented as a

function of frequency. The dB_{ht} (*species*) level is estimated by passing the sound through a filter that mimics the hearing ability of the species, and measuring the level of sound after the filter; the level expressed on this scale is different for each species (which is the reason that the specific name is appended) and corresponds to the perception of the sound by that species. A set of coefficients is used to define the behaviour of the filter so that it corresponds to the way that the acuity of hearing of the candidate species varies with frequency: the sound level after the filter corresponds to the perception of the sound by the species. The scale may be thought of as a dB scale where the species' hearing threshold is used as the reference unit. The benefit of this approach is that it enables a single number (the dB_{ht} (*species*)) to describe the effects of the sound on that species.

The perceived noise levels of sources measured in dB_{ht} (*species*) are usually much lower than the unweighted levels, both because the sound will contain frequency components that the species cannot detect, and also because most marine species have high thresholds of perception of (are relatively insensitive to) sound. If the level of sound is sufficiently high on the dB_{ht} (*species*) scale it is likely that avoidance reaction will occur. Currently, on the basis of measurements of fish avoidance of noise reported in Nedwell *et al* (1998b) it is proposed that levels of 90 dB_{ht} (*species*) and above will cause significant avoidance reaction, with strong avoidance by most individuals at 100 dB_{ht} (*species*). Mild avoidance reaction occurs in a minority of individuals at levels above about 75 dB_{ht} (*species*).

It should be noted however that Nedwell *et al* (2004b) lists the range of marine mammal and fish species for which audiograms are available, and points out that "...these represent a small subset of the marine animals that are of economic or conservational significance worldwide." The report further notes that "...those audiograms that are available are generally of a lower quality than would be desirable for use as the basis of a robust dB_{ht} (*species*) algorithm."

The lack of a comprehensive and reliable set of audiograms of abundant or significant marine mammals and commercially significant fish species is currently a major gap in the knowledge in respect of the environmental effects of man-made underwater noise.

Models for estimating underwater noise. In order to completely characterise the effects of a noise source it is necessary to understand the level of noise it creates and the rate at which the noise decays with distance. Man-made noise sources can usually be characterised as point sources when compared with the geological scale of the ocean, and hence they cause increased levels of noise in a relatively localised area. By comparison background noise caused by the natural physical processes of the ocean tends to be relatively uniform. Therefore, near to a man-made noise source, it is possible that the noise will greatly exceed the level of background noise. As the distance from the source increases the noise level will reduce until it reaches the level of the background noise, at which point it is reasonable to assume there is no effect of the noise.

In order to provide an objective and quantitative assessment of degree of any environmental effect it is therefore necessary to estimate or measure the level of noise from the source as a function of range. While numerical models are initially appealing as a means of predicting noise, many of them are unduly simplistic, or require as an input a range of geological, bathymetric or meteorological parameters which are usually unknown. In the current state of knowledge it is therefore best to rely on empirical models based on actual measurements made in the field.

Empirical models. If sufficient actual measurements of a particular noise source are taken a reliable empirical model for estimating noise levels may be formed. Often, measured data are fitted to an expression of the form

$$RL(R) = SL - N \log R - \alpha R$$

where $RL(R)$ is the received level at a range from the source of R metres, and N and α are coefficients relating to geometric spreading of the sound and absorption of the sound respectively. In many cases only the geometric term is required to describe propagation and the absorption term will be omitted. SL is the Source Level, or apparent level of noise at 1 metre. If the threshold level of sound for a given effect is known, an estimate may be made of the range within which this effect will occur. Such empirical models are easy to use and often provide a more reliable estimate of level than numerical models, where many of the physical parameters required will be unknown.

It should be noted that the values of both Source Level and Transmission Loss will depend on the quantity which is measured. They will be different, say, for impulse or peak pressure, and have been shown to also vary significantly for values of dB_{ht} (*species*) calculated for different species (Nedwell (1999)).

In general the strategy for the measurements presented herein has been chosen with mild injury and behavioural effects in mind, and with the aim of both measuring and assessing the noise and providing empirical models for future use. These provide estimates of the noise levels from construction noise sources which have been validated at distances of about 100 m up to 10 km and more. No measurements have been made which can be used to confirm the model at closer ranges than 100 m. Consequently caution should be used when using the models at such close ranges, for instance when modelling injury at close range. Where this is a concern confirmatory measurements of actual levels at these ranges may be required.

3.5 Shoals: typical windfarm locations

At the commencement of the research project it was noted that the typical location of windfarms is in shallow coastal areas, which makes the installation of foundations easier, quicker and hence less expensive. Such areas have not received great attention from the underwater acoustics community. Consequently there is no information in the public domain on typical levels of background noise or on the propagation of noise in these areas.

In describing these areas the term “shallow water” is frequently used. However, this is a subjective term. For instance, references to shallow water noise in the underwater acoustics literature typically result from military interest and refer to water of the order of 200 m deep. The authors sought a description of the typical location of windfarms, and propose the term “shoals” to describe a typical location.

3.6 The need for mean and statistical descriptions of noise

An important consideration in specifying the measurements concerned the statistics of the noise. In determining the zone of influence of a man-made source of noise it is of interest to know not only the mean properties of noise but also its statistical properties. For instance, it is generally considered that beyond the range at which the source falls to the level of background noise it can have no possible effect.

In a deterministic model this is an exact range which does not vary, but Figure 1 illustrates a more realistic model of noise. In practice, the noise will not be at a constant level but will vary over the long or short term, depending on many physical parameters, and, as illustrated, there will be a spread of recorded background noise levels. The mean level of the background noise will typically be relatively constant with range from the noise source. In contrast, the level of noise from the source will decrease with range due to spreading and absorption; however there will also be a spread of levels from the source, caused by variations in source level and varying propagation conditions.

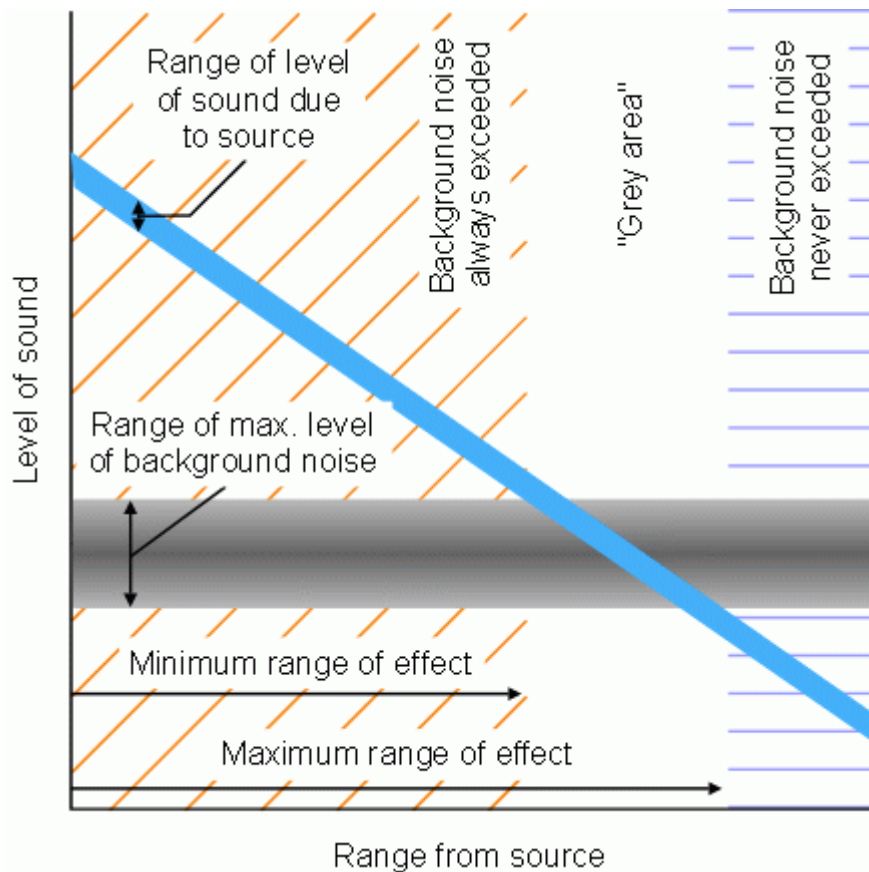

Figure 1. A model of the noise from a source, and ambient noise, where levels vary.

At a great enough range, even when the variation of noise is taken into account, the highest level of noise from the source will always be less than the lowest level of background noise; the zone beyond this range is therefore the area of “no possible effect”. At a lesser range the highest level of background noise is always below the lowest level of noise from the source; the zone within this range is the “zone of possible effect”. Between these zones is a grey area, where the source may or may not be above the level of the background noise.

These considerations indicate why an understanding of not only the mean levels of noise but also a measure of its statistics, or variability, is essential when estimating the possible environmental effects of noise.

3.7 Possible measurement strategies

There are two possible strategies to the implementation of noise monitoring – fixed position monitoring and transects. These are described and their relevant merits discussed below.

3.7.1 Fixed position monitoring

In this approach a range enclosing an area which it is deemed “acceptable to affect” is defined. This may be an area which is small compared with a local fish breeding ground, of minimal size when compared with local marine mammal migratory routes, or which can be demonstrated to be smaller than that already affected by pre-existing noise sources. The monitoring of the noise is relatively simple; the aim is to answer the question “at the range at which it is being monitored is the noise causing an effect?” The noise can be monitored on a permanent or sampled basis, and, in the event of the noise exceeding a set threshold, a remedial action can be triggered. The remedial action may, for instance, be to cease construction until the reason for the high level is identified and remedied. This approach is applicable to monitoring where there are well-defined limits that have been set by regulators, or by the organisation creating the noise if it is self-regulating.

An example of this strategy may be found in Figure 2, which illustrates a typical result of fixed position monitoring, in this case from monitoring of vibropiling undertaken on behalf of the Environment Agency (Nedwell *et al* (2003)). The figure illustrates the level of the sound in dB as a function of the time of day, recorded at a range of 417 m. The upper trace, in red, indicates the unweighted sound level in dB re 1 μ Pa, and the lower (blue) trace the level in dB_{ht} (*Salmo salar*), i.e., as a frequency-weighted level above the hearing threshold of salmon. Also marked on the figure are periods during which vibropiling was in progress.

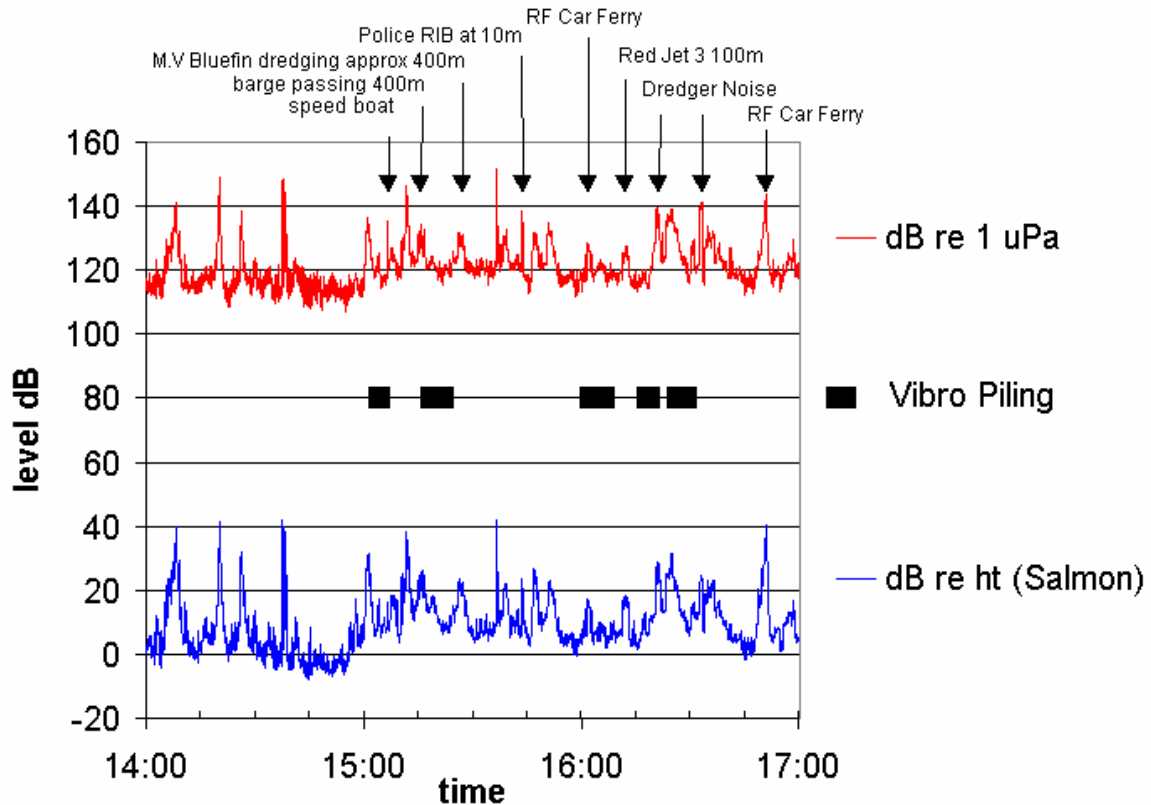

Figure 2. An example of the monitoring approach to noise measurements, from Nedwell, *et al*, (2003), showing both unweighted levels and dB_{ht} (*Salmo salar*).

The monitoring indicates that there are occasional short but relatively large increases in the unweighted sound pressure level, up to about 150 dB, associated with the passage of vessels and noise from a dredger. The dB_{ht} (*Salmo salar*) levels are much lower than the unweighted levels; this results from salmon being relatively insensitive to sound, and to a lesser degree from their limited hearing bandwidth. The monitoring has demonstrated that in neither case is there a discernible increase of the signal when the driving is taking place compared to when it is not. It may be noted, though, that fixed position monitoring has drawbacks in relation to understanding the spatial behaviour of the field. The above measurement, for instance, has not yielded any information as to the range at which the vibropiling noise would exceed the background noise.

3.7.2 Assessing spatial and temporal variability: transects

In principle, given the level of noise generated by a source, the rate at which the noise reduces with distance and the level at which a given effect will occur, it is possible to calculate a range from the source at which the effect will occur. However, the statistics of both the man-made noise and the background noise must be assessed in order for a complete understanding of the

potential effects of the noise. Background noise is affected by a range of physical quantities, such as the local water depth, substrate type, wind speed, degree of local shipping, etc. The propagation from the source is similarly affected by variations of, or inhomogeneities in, the temperature and salinity of the water, bubble content, etc. Finally, the source itself may vary with time.

The area affected by the noise thus may vary greatly from time to time, and, while the mean area affected is a valuable measure, a statistical measure, such as the area affected 5% of the time, may be equally important. Generally, a reliable measure of the statistical properties of the noise requires many repetitive measurements, allowing the spatial effects (variation with distance) and the temporal effects (variation with time) to be assessed. To achieve this measurements must be taken over a range of distances from the source and the measurements must be repeated until sufficient confidence in their statistical properties is obtained.

For the measurements detailed in this report transects, or measurements along lines radiating outwards from the source, have been used. Since the variation in noise levels with range is usually geometric, the ranges are usually chosen to also increase geometrically (e.g. 100 m, 200 m, 400 m and so on), as this will cause roughly equal decrements in noise.

4 Instrumentation and experimental protocol

This section describes the means by which the measurements have been taken, and the instrumentation and techniques used in collecting them. Measurements were taken of both background noise, and noise during construction.

4.1 Factors limiting the measurements

During the initial nine month period of the measurements the work was largely reactive, since it involved taking measurements of construction noise as opportunities were presented. Roughly, about half of the effort was on measurements of man-made noise sources during construction, and half on background noise. Measurements of noise were taken at all times of the day, both at night and during the daytime. Safety considerations limited the weather conditions in which measurements were made to Beaufort Force 6 and below, in moderate or lower sea state. It may be noted that this latter requirement limited the range of operational conditions in which noise could be measured; it is intended to make use of autonomous recording equipment in subsequent measurements to remedy this shortcoming.

4.2 Description of the types of noise measured

Measurements have been taken as the opportunity arose of the following types of construction noise:

1. rock socket drilling at North Hoyle,
2. cable trenching at North Hoyle, and
3. monopile hammering at North Hoyle and Scroby Sands.

In addition, measurements have been taken of background noise at North Hoyle and Scroby Sands to characterise the normal noise levels at each locality. Where necessary additional measurements have been taken of any predominant noise sources that exceed the expected background level, for example nearby oil and gas production installations.

4.3 The transects used for measurements

This section describes the sites where measurements have been taken and describes in detail the transects used at these locations. These were used to estimate the source level and transmission loss of construction sources, and were additionally used when making measurements of background noise.

4.3.1 North Hoyle

The North Hoyle Offshore Windfarm is a windfarm site operated by National Wind Power Ltd. on behalf of RWE Innogy plc. It is approximately 7.5 km north of the North Wales coast between Prestatyn and Rhyl, and is situated in water of depth 7 – 11 m LAT (Lowest Astronomical Tide). The site is superficially composed of predominantly gravelly sand with some small infrequent pockets of fine sand, gravel and clay. Underlying the superficial layers of 14 m or so is sandstone.

The site consists of an array of 30 turbines, each rated at 2 MW. At the commencement of this study the site was under construction and measurements were taken at regular intervals throughout the 8-month construction period. The windfarm site became operational in November 2003. Pile hammering was investigated thoroughly. Measurements of noise from underwater drilling and cable laying were also taken. Background noise measurements were taken around the windfarm site. Figure 3 presents a sketch of the transect lines at North Hoyle.

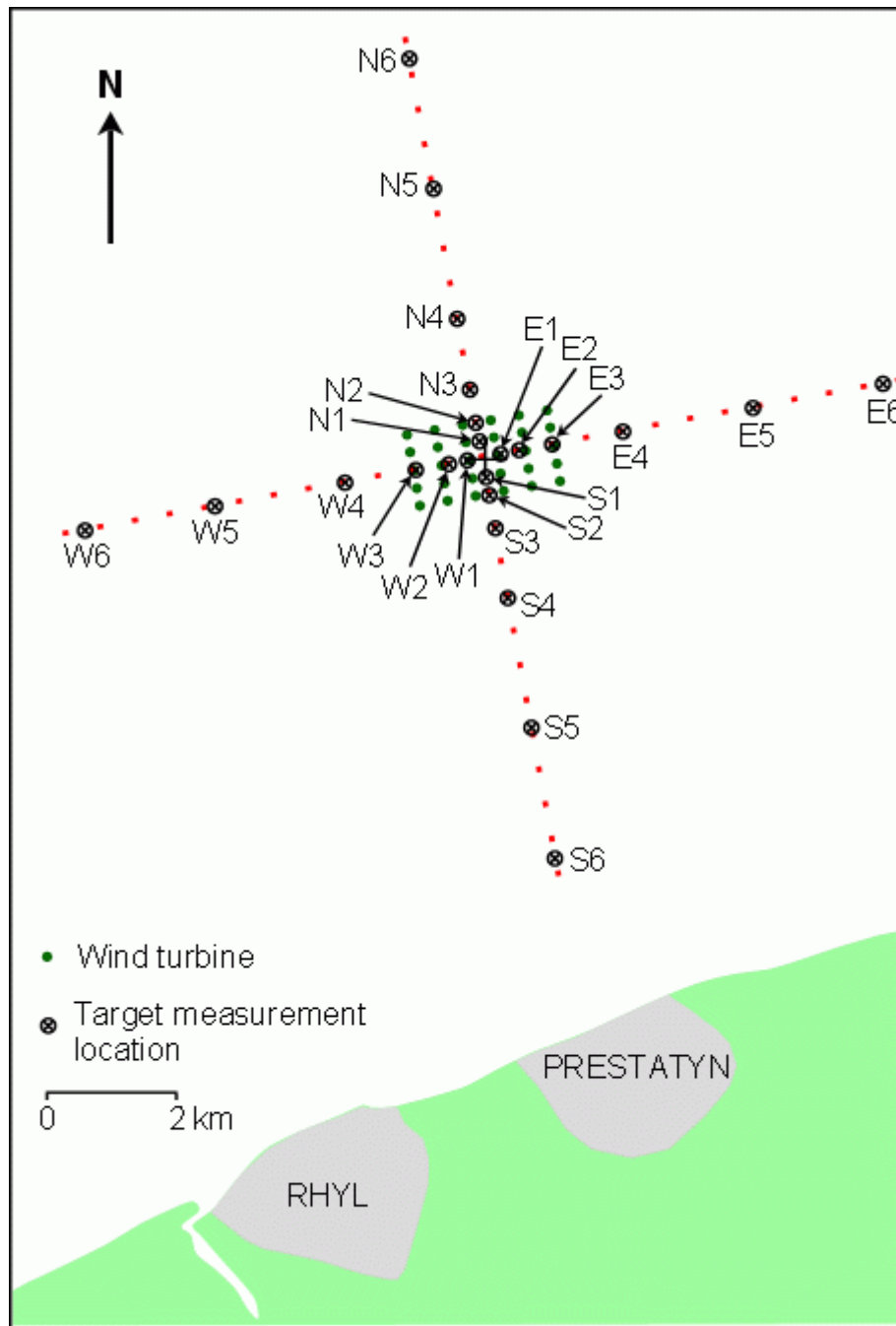

Label	Dist. (m)	Bearing (true)	Calculated position	Label	Dist. (m)	Bearing (true)	Calculated position
N1	250	348	53.25.812N 3.26.747W	W1	250	258	53.25.652N 3.26.922W
N2	500	348	53.25.944N 3.26.794W	W2	500	258	53.25.624N 3.27.143W
N3	1000	348	53.26.208N 3.26.888W	W3	1000	258	53.25.568N 3.27.586W
N4	2000	348	53.26.736N 3.27.077W	W4	2000	258	53.25.455N 3.28.473W
N5	4000	348	53.27.793N 3.27.454W	W5	4000	258	53.25.231N 3.30.245W
N6	6000	348	53.28.849N 3.27.831W	W6	6000	258	53.25.006N 3.32.018W
S1	250	168	53.25.548N 3.26.653W	E1	250	78	53.25.708N 3.26.478W
S2	500	168	53.25.416N 3.26.606W	E2	500	78	53.25.736N 3.26.257W
S3	1000	168	53.25.152N 3.26.512W	E3	1000	78	53.25.792N 3.25.814W
S4	2000	168	53.24.624N 3.26.323W	E4	2000	78	53.25.905N 3.24.927W
S5	4000	168	53.23.567N 3.25.947W	E5	4000	78	53.26.129N 3.23.154W
S6	6000	168	53.22.511N 3.25.570W	E6	6000	78	53.26.354N 3.21.381W

Figure 3. Measurement transects at North Hoyle.

The measurements at the North Hoyle construction site have been taken along two transects, one running parallel to the shore and of reasonably constant depth, the other perpendicular to the shore line and representing a line of approximately constant slope. The two transects meet in the centre of the windfarm site. The reason for choosing this orientation of the transects is that the two cases of “constant depth” and “maximum rate of change of depth” were thought to be the two extreme cases in respect of propagation of noise. It may be noted that nearby there was an oil and gas production platform "*BHP Douglas*".

4.3.2 Scroby Sands

Scroby Sands offshore windfarm is, at the time of writing, under construction off the Norfolk coast near Caister-on-Sea. It represents the second major offshore windfarm development in the UK, and is owned by Powergen Offshore Renewables Ltd. The site will eventually consist of 30 2 MW turbines, the nearest located 2.3 km from the shore. The site is located on a sand bank known as the Middle Scroby Sands, which lies approximately 3 km east of the Great Yarmouth coastline. The depth of water in which the windfarm is constructed varies between 0.4 m and 7.5 m LAT.

The transect lines used at Scroby Sands consist of two perpendicular courses that extend from approximately the centre of the windfarm. It was not possible to use lines of roughly constant depth and maximum rate of change of depth, as at North Hoyle, because it was not possible to work near to the very shallow water at South Scroby. Consequently the transect lines chosen were about 45° and 135°. Figure 4 presents a sketch of the transects.

4.4 Instrumentation and measurement procedure

The measurements made and reported herein have been measured by the transect method described in section 3.6.2. Measurements have been made from a dedicated survey vessel, which was used to move from location to location along transect lines. Each measurement location was identified by means of the GPS. At each measurement location the measurement vessel was manoeuvred into position, the vessel's engines were stopped and all electrical equipment was turned off, so that the vessel was effectively “dead in the water”. Where there was significant drift due to wind or water currents the drift was assessed and the vessel was stationed updrift of the desired measurement point, such that by the time of taking the measurement it would have been approximately at the desired measurement position. The GPS information was in addition recorded by the measurement system as measurements were made so that any difference could be allowed for in the subsequent analysis. The measurement hydrophone was deployed into the water mounted on an anti-heave buoy, at first at 5 m, then at 10 m depth, while measurements of noise were made. The purpose of the anti-heave buoy was to ensure that flow noise over the hydrophone, caused by it being pulled up and down in the water by wave action, did not contaminate the measurements. Wave slap from the vessel's hull was considered and investigated as a further contaminant. Boats were chosen that had a hull design giving minimum slap; it was found by listening to the recordings that in this case it did not contribute to the noise. Nevertheless, the hydrophone was allowed to drift at least 10 m away from the vessel before measurements were taken.

The hydrophone cable was connected to the signal conditioning and digitising equipment, which is fully described in Appendix B. In brief this comprised a conditioning amplifier, a spectral pre-emphasis amplifier (to ensure sufficient dynamic range was available on the recording equipment), analog-to-digital converter and laptop computer. This equipment was stored in the cabin of the vessel.

Prior to acquiring any data the signal to be recorded was checked for quality, by both listening to it and by visual inspection of the time history. At this point the signal conditioning settings, such as gain and pre-emphasis, were set to give the most appropriate input to the data acquisition card. The measurement was then taken. Simultaneously a record was made of

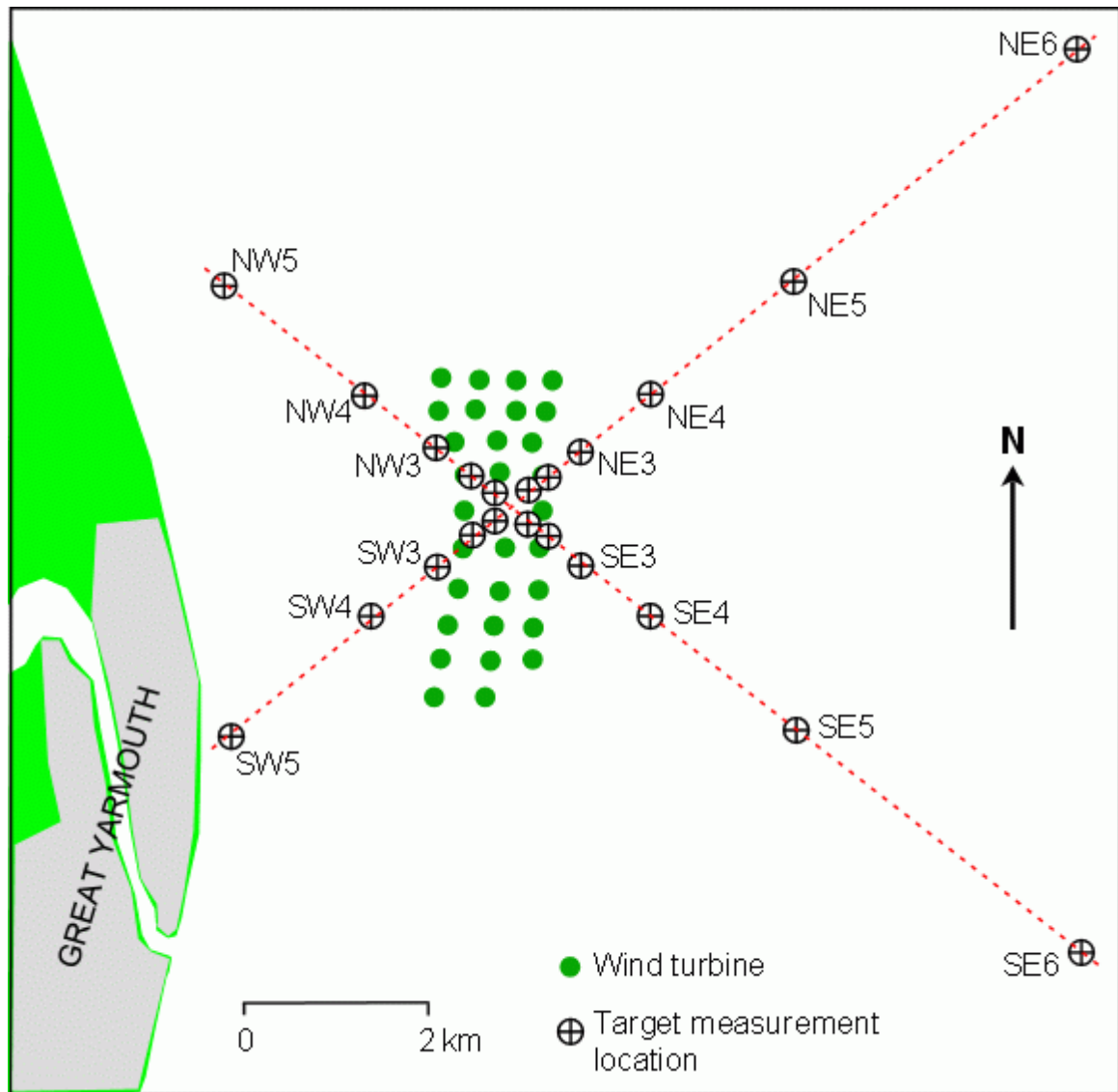

Label	Dist (m)	Bearing (True)	Position	Label	Dist (m)	Bearing (True)	Position
NE 1	250	45	52.38.775N 1.47.757E	NW 1	250	315	52.38.775N 1.47.443E
NE 2	500	45	52.38.871N 1.47.915E	NW 2	500	315	52.38.871N 1.47.285E
NE 3	1000	45	52.39.062N 1.48.229E	NW 3	1000	315	52.39.062N 1.46.971E
NE 4	2000	45	52.39.444N 1.48.859E	NW 4	2000	315	52.39.444N 1.46.341E
NE 5	4000	45	52.40.207N 1.50.118E	NW 5	4000	315	52.40.207N 1.45.082E
NE 6	8000	45	52.41.734N 1.52.637E	SE 1	250	135	52.38.585N 1.47.757E
SW 1	250	225	52.38.585N 1.47.443E	SE 2	500	135	52.38.489N 1.47.915E
SW 2	500	225	52.38.489N 1.47.285E	SE 3	1000	135	52.38.298N 1.48.229E
SW 3	1000	225	52.38.298N 1.46.971E	SE 4	2000	135	52.37.916N 1.48.858E
SW 4	2000	225	52.37.916N 1.46.342E	SE 5	4000	135	52.37.153N 1.50.116E
SW 5	4000	225	52.37.153N 1.45.084E	SE 6	8000	135	52.35.626N 1.52.631E

Figure 4. Measurement transects at Scroby Sands.

hydrophone depth, sea state, weather conditions, local shipping movements, signal conditioning settings, bathymetry details and measurement GPS co-ordinates. Generally, signals were recorded for 30 seconds and at a sample rate of at least 300,000 samples per second. The high sample rate was required to ensure that the measurements could be used to

estimate any environmental effect. Many marine mammals are sensitive to sound at frequencies in excess of 100 kHz; however fish are sensitive to low frequencies of, say, 50 Hz to 400 Hz. Hence the noise had to be recorded over a wide bandwidth of 10 Hz to 150 kHz. Once the recording was made spectral analysis was performed on a segment of the recording, both as a further quality check and to give feedback on the type of noise being measured.

Following the taking of the sound measurement at each location a conductivity, temperature and salinity (CTD) probe was lowered over the side of the vessel to the seabed while the data acquisition system logged the data. From this data a sound velocity profile was derived, and this information has been archived for each measurement location. Sound velocity profiles are an input that is required for sound propagation modelling programs. The purpose of this measurement was to enable information to be recorded that would, in principle, allow such modelling programmes to be used to model the propagation of noise during windfarm construction and operation.

The above process was repeated for each measurement location along a transect. During the measurements, where required, an investigative approach was used to identify and characterise noise sources in order that their potential effects could be best evaluated.

4.5 The processing of measurements

4.5.1 General processing

The noise sources measured during the programme may be broadly categorised into two main types. These comprise:

1. sources having periodic events of short duration, such as piling, which are generally termed “impulsive noise” in this report, and
2. those of roughly constant level, such as background noise and rock drilling noise, which are generally termed “steady state noise” in this report.

The importance of this distinction is that data for these two sorts of source tend to be processed in different ways.

Impulsive sounds usually have time histories which exhibit a characteristic behaviour, and hence are usually analysed and interpreted in the time domain, by inspection of their time histories. For sources such as explosive blast and piling the typical measurement quoted is the peak-to-peak sound pressure level, and/or the impulse.

While the spectrum of the impulsive sound (i.e. its frequency content) is of interest, it suffers from the disadvantage that, when expressed in the conventional way as spectral level, its absolute level is dependent upon the length of time over which the measurement was made. This is one reason that the dB_{ht} measure, which avoids this problem, may be preferred.

Continuous noise, by comparison, is often relatively featureless in the time domain, and hence analysis is usually performed in the frequency domain by inspection of the spectrum of the sound. Spectra may vary considerably from one record to another, and hence the averaged power spectral density tends to be used.

Both time histories and spectra have been calculated for the data presented herein, and have been used to illustrate features of the noise measured as required.

4.5.2 Processing environment and quality checks

Power spectral densities presented herein have been estimated by averaging thirty consecutive one-second recordings. The measurements were processed in batches using MATLAB, a mathematical matrix computing language produced by The MathWorks of Natick, Massachusetts.

The basic steps in the processing and quality checking were as follows:

1. the log file for the measurement was interrogated to find equipment settings, GPS positions and other information, such as weather conditions;
2. the signal was spectrally de-emphasised;
3. the signal was converted from volts to Pascals using the hydrophone sensitivity and amplifier gain contained in the data's header block;
4. the signal was high pass filtered at 10 Hz to remove any low frequency hydrodynamic noise due to the passage of waves;
5. the levels of sound were calculated in dB re 1 μ Pa, either as peak level and impulse level for impulsive sounds, such as piling, or as sound power spectra for continuous noise, such as drilling;
6. the dB_{ht} levels were calculated for selected species of fish and marine mammals;
7. time history files, with levels scaled to dB re 1 μ Pa, and power spectral density files were created. Also, sound files (*.wav files) were created. Each of these records was inspected for quality. Records were checked visually using the time history to check for transients or other spurious data. The spectra were checked for tonal noise, such as 50 Hz mains noise, depth finder or sonar transmissions. Finally, every recording was listened to for spurious noises.

Data which passed the quality checks and were processed were stored for further use.

5 Background noise measurements

The aim of the measurements of background noise was to assess the prevailing level, spectrum and variability of background noise, and to compare it with the well-documented information for background noise in deep water.

5.1 Background noise in conventional units

Figure 5 summarises the measurements taken of background noise.

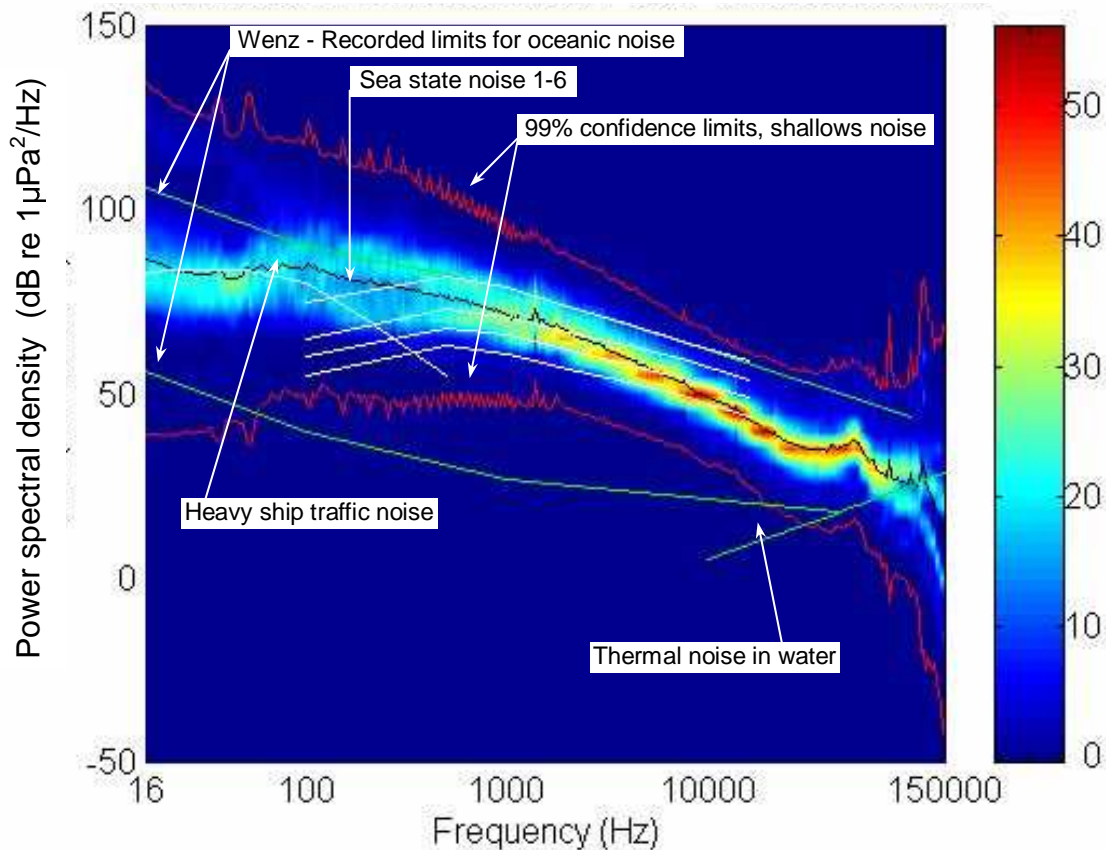

Figure 5. The measurements of background noise in shallows.

The figure, which is slightly unusual in its presentation of the data, warrants explanation. It illustrates the power spectral density of the background noise as a function of frequency; the figure shows this quantity for all of the measurements of background noise taken (at both North Hoyle and Scroby Sands). The values of power spectral density have been smoothed over frequency bands 1/27th of an octave wide. The black line indicates the mean of the results. The red lines above and below the mean indicate the 99.7% confidence limits of the sound measured. It may be seen that there is a significant variation in noise levels, over a range of 50 dB or more, at the lower frequencies.

In addition, the colour of the plot indicates the distribution of the noise levels. The results at each frequency have been divided into 5 dB bins, and the number of results in the bin compared with the overall number of measured levels at that frequency. Thus, for each centre frequency, the plot shows a histogram of the measured band levels from 16 Hz to 150 kHz. The scale appended relates the colour of the plot to the percentage of results in the bin; at the most dense (i.e. where the variability was the least) 50% of the results or so fell into the 5 dB bin).

It may be seen that the variability of the levels depends significantly on frequency, with the results splitting into two bands. In the upper band, at frequencies of about 2 kHz to 100 kHz, there is little variability of the level of noise, with the results in general clustering closely about the mean. It is thought that this band corresponds to wind- and wave-generated noise. However, in the second band, at frequencies below 1 kHz or so, the results spread significantly. Interpretation of these results indicates that they are due to shipping movements. When there is local movement of shipping the levels increase significantly; however, even when there is no apparent local movement, distant ships can still contribute significantly to the noise.

Illustrated on the figure are measurements of deep water background noise reported by Wenz (1962), who summarises data provided by Knudsen (1948) and others. The green lines above and below the plot indicate the upper and lower bounds of deep water ambient noise. The purple lines indicate specific features of the noise. At low frequencies, below 200 Hz, the noise is dominated by shipping noise (in this case, the line for “moderate shipping” has been used). At frequencies from about 200 Hz to 10 kHz the noise results from sea surface effects; the lines show an increase with increasing sea state.

Several differences of the current studies' measurements from this deep water data may be identified.

1. In general, the ambient noise levels which were recorded in the shoals at North Hoyle and Scroby Sands are towards the upper bound of the deep water ambient noise levels presented by Wenz. This would tend to confirm the received wisdom that “coastal waters are noisier than deep water”.
2. For frequencies below about 1 kHz the noise is thought to be dominated by shipping noise. For this reason the levels are rather variable, since they depend on the quantity of shipping and its proximity to the measurement position. It is interesting to note that this noise source dominates to higher frequencies than in the deep water case; this may well be a result of the smaller ships and boats that are typically found in coastal waters having higher-pitched spectra.
3. From about 2 kHz upwards the level of noise in the shoals is fairly constant; unlike the Wenz results there is little dependence of the noise level on sea state. It is not certain why this should be the case. It may be that higher levels of surface noise resulting from increased wind are counteracted by poorer propagation caused by entrainment of bubbles. It may also be the case that the noise is not dominated by sea surface noise, but by other processes.
4. It should be noted that the peak in the spectrum at about 100 kHz is caused by the resonance of the hydrophone used. Since the hydrophone was fully calibrated it was possible to “detrend” the data by applying inverse processing. It was found that this caused the spectrum to follow a line of roughly constant reduction with frequency at high frequencies.

Figure 6 illustrates the measured noise level as a function of the time of day. It is interesting to note that during the working day, from about 9 a.m. to 5 p.m., the noise varied significantly more than at other times of day. It is thought that this confirms the dependence of the low frequency spectrum on shipping noise; during the working day in coastal waters the higher number of short, local ship movements leads to occasional increases in level as each ship passes. In deep water this is not the case, as deep water shipping, typically travelling on voyage of many days, must ply routes at all times of day or night. Figure 7 presents the same data, but in this case statistical measures have been applied to the data.

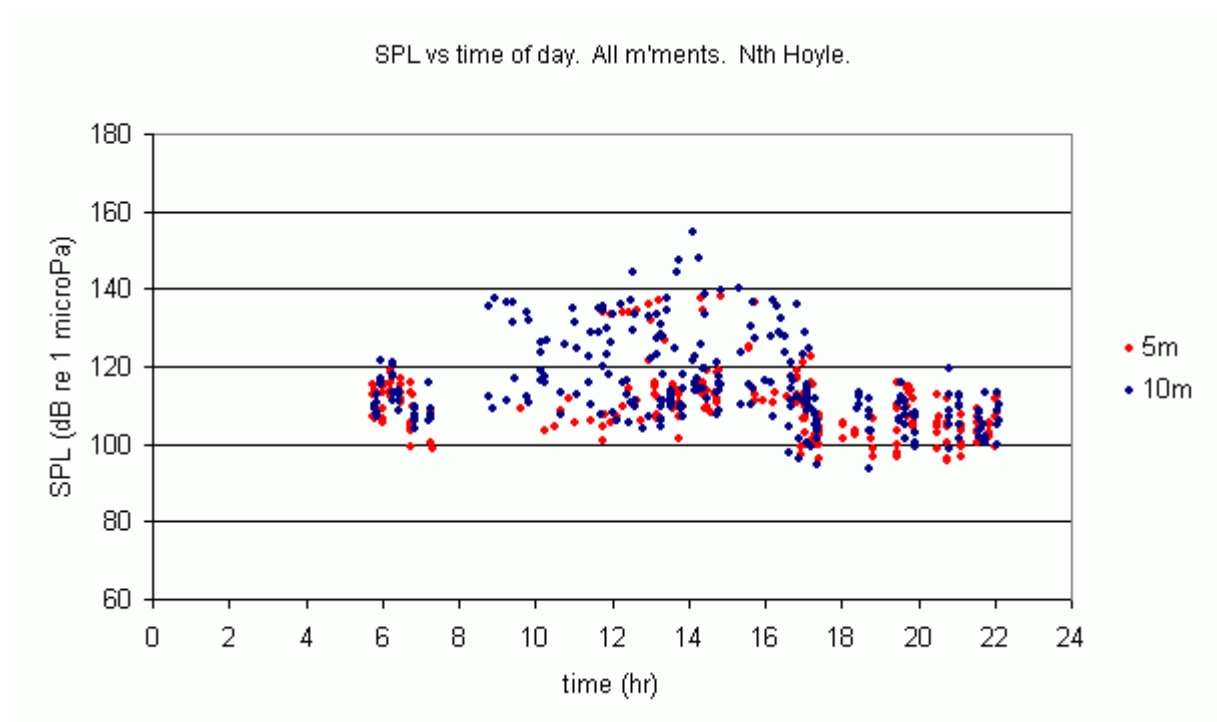

Figure 6. Noise level vs time of day for all measurements of background noise at North Hoyle.

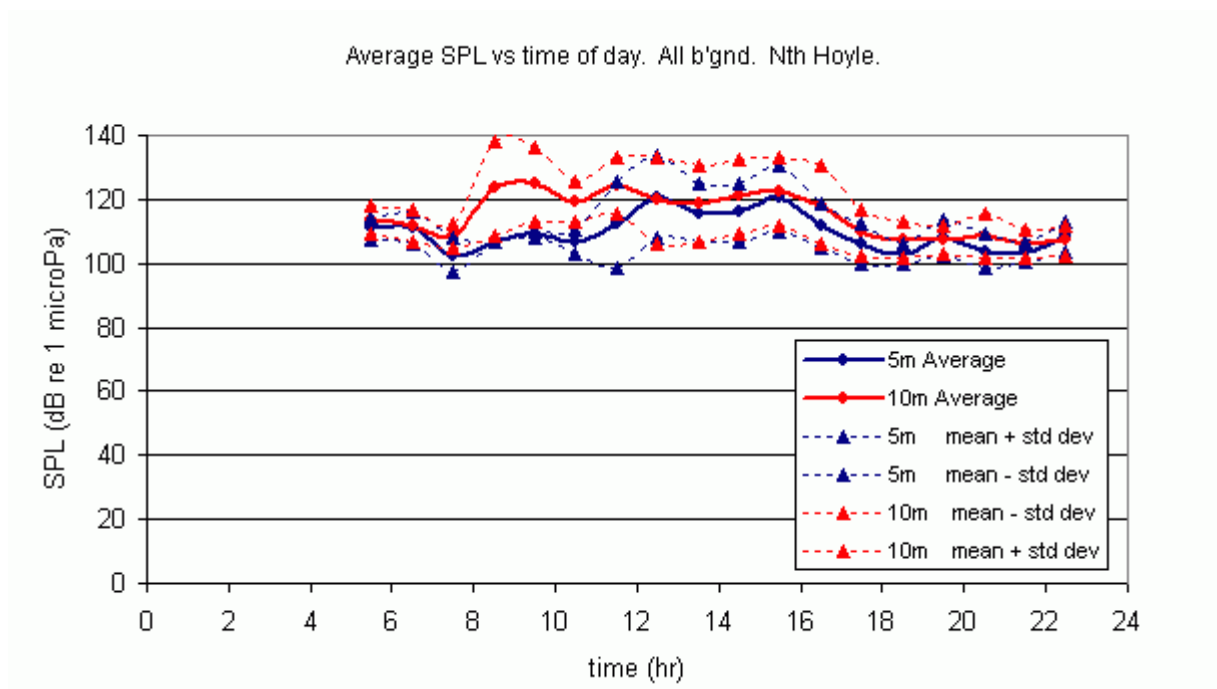

Figure 7. Averaged SPL vs time of day, with standard deviation, produced by dividing the measurements of Figure 6 into bins spanning one hour and calculating mean and standard deviation.

Figures 8 and 9 indicate the level of noise at depths of 5 m and 10 m respectively as a function of the wind speed. It is interesting to note that the noise levels in both cases are higher at low wind speeds. This is unexpected; as indicated by the Wenz results noise generally is expected to rise with increasing wind speed. It is not possible to unequivocally

determine the reason for this feature of the results, but it is possible that in shoals rolling waves at the higher wind speeds drive bubbles into the water. These have a well-documented action in attenuating the propagation of noise and would hence tend to reduce the area from which noise could reach any point.

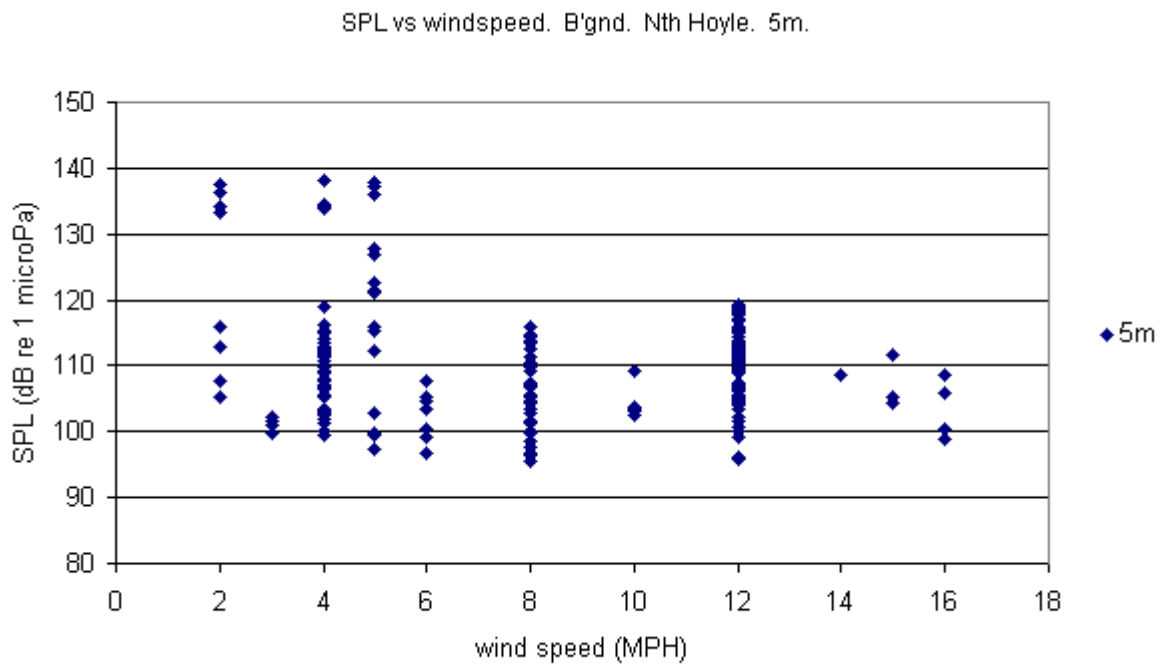

Figure 8. SPL vs wind speed at 5 m depth for measurements of background Noise at North Hoyle.

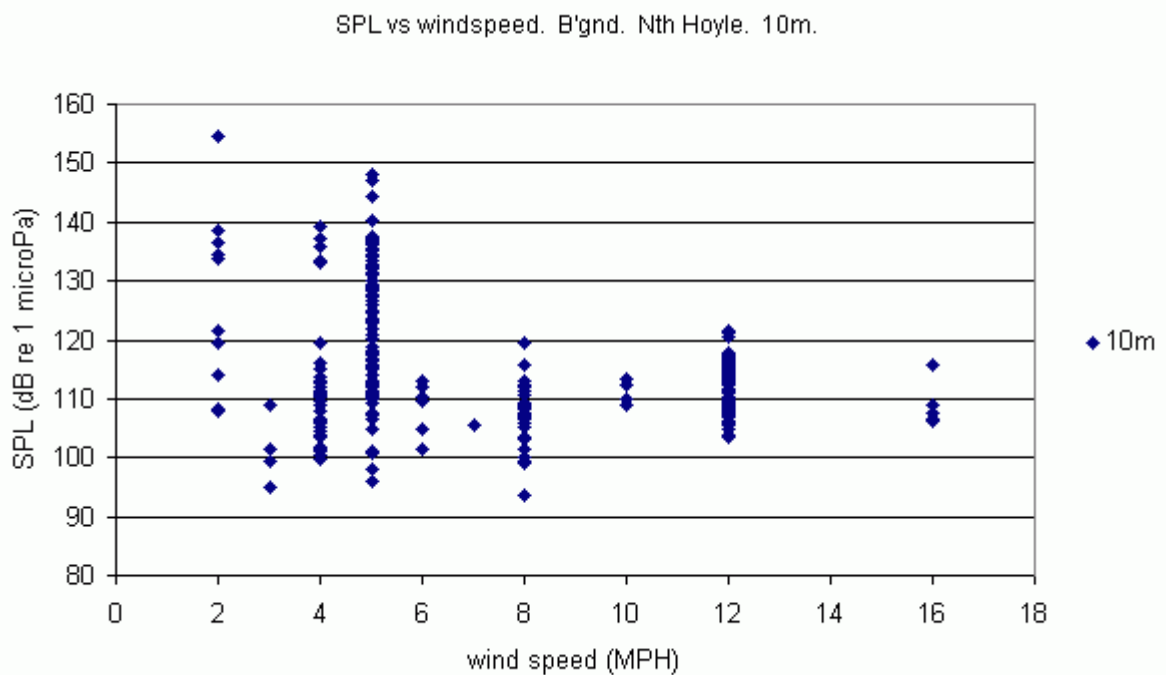

Figure 9. SPL vs wind speed at 10 m depth for measurements of background noise at North Hoyle

Figure 10, which compares the measurements taken at North Hoyle with those taken at Scroby Sands, shows the power spectral densities at the two sites; the results of the measurements at both 5 m and 10 m depth are shown.

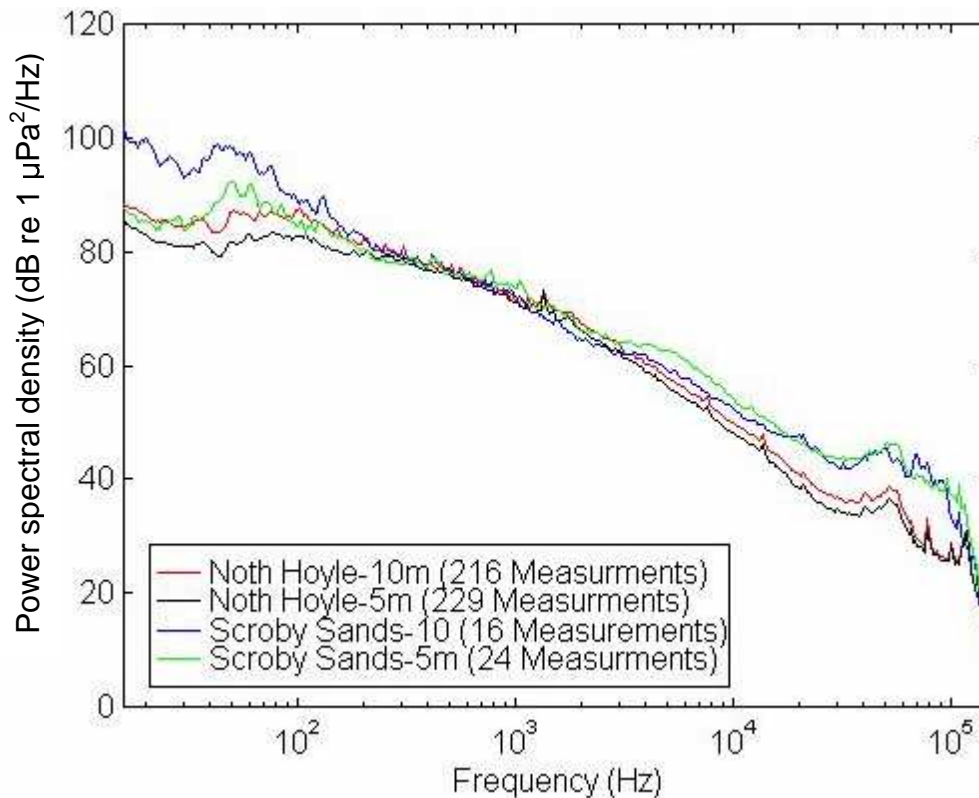

Figure 10. A comparison of the mean ambient noise levels recorded at North Hoyle with those recorded at Scroby Sands.

In general, the noise at both sites in the frequency range from 200 Hz to 10 kHz is similar. However, the noise is slightly higher at high frequencies at Scroby Sands, by up to about 10 dB. It is also about 10 dB higher at low frequencies. The reason for these differences cannot be identified from the data; indeed, it was thought that there were generally fewer shipping movements at Scroby Sands than at North Hoyle, so the low frequency noise would actually be expected to be lower in the former case.

Figure 11 and 12 are histograms indicating the variability of the overall sound pressure level for measurements at North Hoyle and Scroby Sands respectively. The measured SPL, at 5 m depth and 10 m depth, has been plotted as a function of the number of occurrences of the level within 5 dB bins.

Figure 11 indicates that, for the results at North Hoyle, the distribution of levels is centred around a mean at about 112 dB re 1 μ Pa. It is interesting to note, however, that there is a strong indication that there is a second process in operation, leading to a second peak in the noise distribution where the SPL is about 130 to 140 dB re 1 μ Pa. It is possible that this second peak is caused by man-made noise from other activity near the site; if so, it implies that under some circumstances the noise levels around North Hoyle are raised by about 25 dB or so. It may be seen in Figure 12, which illustrates the same data for Scroby Sands, where there is no platform, that there is no equivalent second peak. It should be noted, however, that in these results the distribution is less uniform. This results from the smaller number of measurements at Scroby Sands (40 measurements in total) when compared with North Hoyle

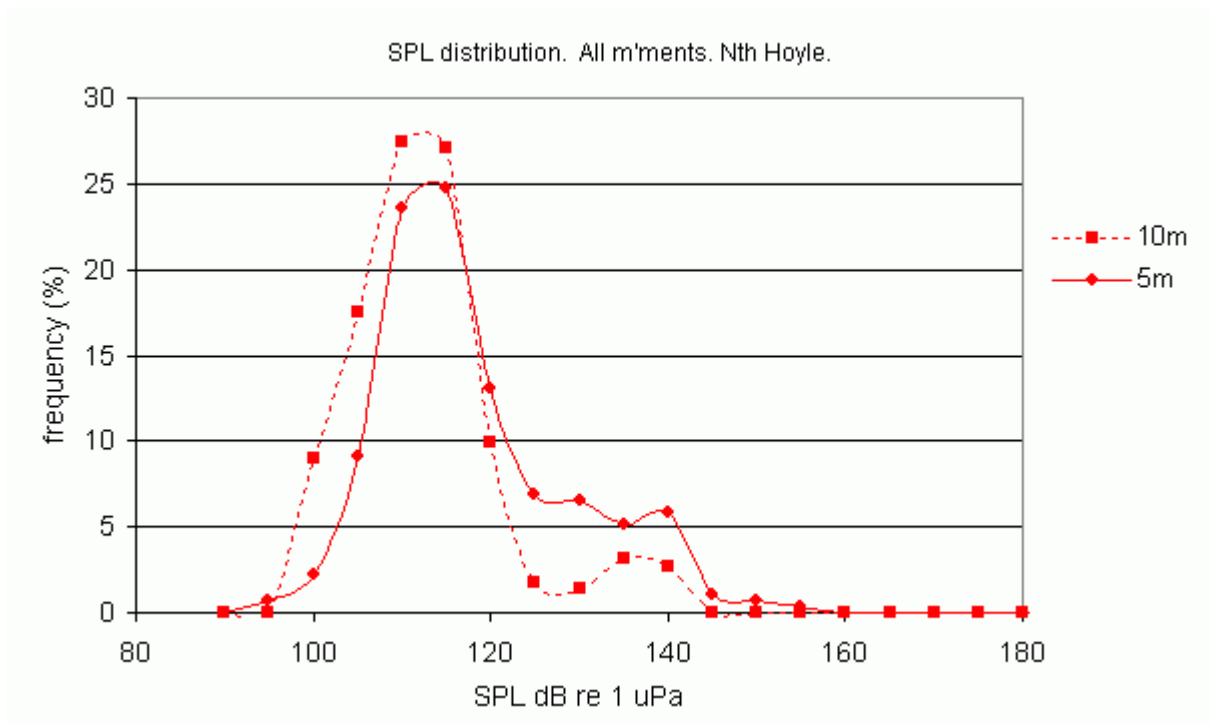

Figure 11. The distribution of SPL for all measurements of background noise at North Hoyle. 222 measurements were used to produce the 5 m distribution, and 276 to produce the 10 m distribution.

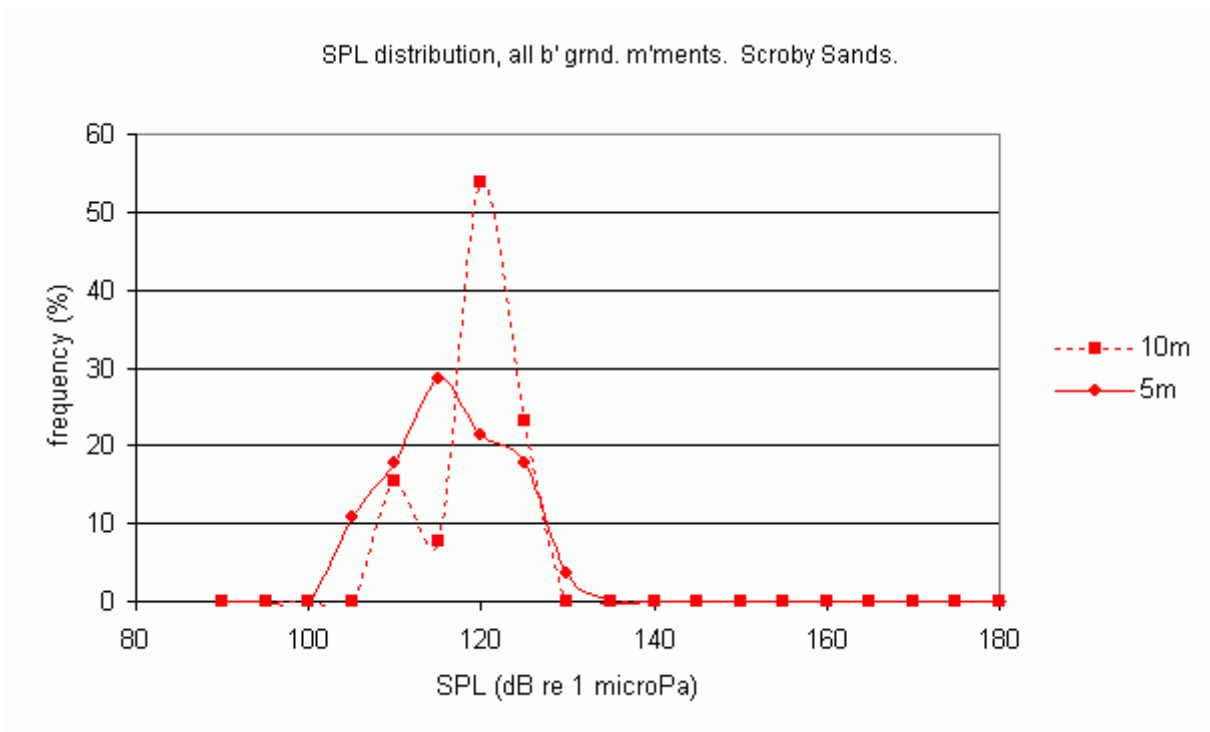

Figure 12. The distribution of SPL for all measurements of background noise at Scroby Sands. 28 measurements were used to produce the 5 m distribution, and 12 measurements to produce the 10 m distribution.

(498 measurements in total), and serves to reinforce the importance of taking a sufficient number of measurements when reliable statistical information is required.

In summary, the measurements of ambient noise in shoals indicate the following:

1. At frequencies of about 2 kHz to 100 kHz there is little variability of the level of noise, with the results in general clustering closely about the mean. It is thought that this band corresponds to wind and wave-generated noise.
2. At frequencies below 1 kHz or so there is significant variability in levels; the noise is thought to be due to shipping movements.
3. In general, the levels are towards the upper bound of the deep water ambient noise levels presented by Wenz (1962).
4. The overall sound pressure level varies significantly more during the daytime than at other times of day, due to the higher number of short, local ship movements.
5. The noise levels are higher at low wind speeds, contrary to the normal assumption that they will rise with increasing wind speed. It is not possible to unequivocally determine the reason for this.

5.2 Background noise in dB_{ht} units

The purpose of this section is to discuss background noise measurements that have been analysed using the dB_{ht} scale. The results give an insight into the background noise environment in which marine animals normally live.

As discussed in section 3.4, the unweighted noise levels are a relatively poor indicator of the likely behavioural effects of noise, because hearing ability and frequency range of hearing may differ greatly from species to species. In addition, since, as indicated in the previous section, the variability of the noise varies with frequency, the variability of the noise perceived by low and high frequency hearers will also vary.

Figures 13 and 14 are histograms illustrating the dB_{ht} levels of the background noise, for the case of the noise measured at North Hoyle, at depths of 5 m and 10 m respectively. Their variability has been indicated by plotting the measured dB_{ht} levels as a function of the number of occurrences of the level within 5 dB bins, in a similar manner to the preceding plots. The levels have been calculated for three fish (salmon (*Salmo salar*), dab (*Limanda limanda*) and cod (*Gadus morhua*)) and for three marine mammals (bottlenose dolphin (*Tursiops truncatus*), harbour seal (*Phoca vitulina*), and harbour porpoise (*Phocoena phocoena*)). These common species were chosen from the relatively limited number of species for which audiograms of useable quality are known (Nedwell *et al* (2004b)), rather than because they are species representing a specific environmental issue in respect of windfarms.

First, it is interesting to note the significant variations in the perceived noise level from species to species, confirming the unsuitability of a simple measure like the unweighted sound pressure level in estimating the behavioural effects of noise.

It may be seen that the marine mammals (dolphin, seal and porpoise) perceive a higher level of noise than the fish (salmon, cod and dab). Of the mammals, the porpoise perceives the highest level, at a mean of about 53 dB_{ht} (*Phocoena phocoena*). By comparison, the three species of fish perceive rather lower levels, the lowest being about 15 dB_{ht} (*Salmo salar*) for the salmon. This species is insensitive to sound, probably as a result of adaption for noisy riverine environments.

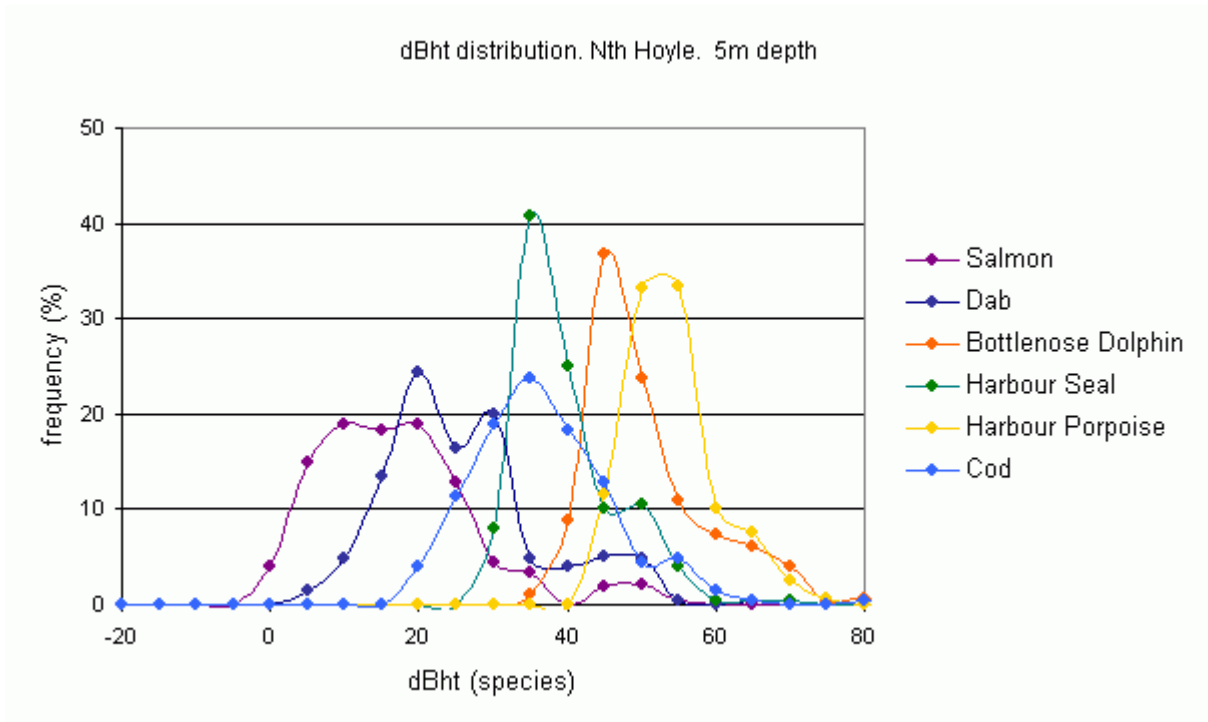

Figure 13. The distribution of dB_{ht} levels for all measurements of background noise taken at 5 m depth at North Hoyle, produced from the same data set as Figure 11.

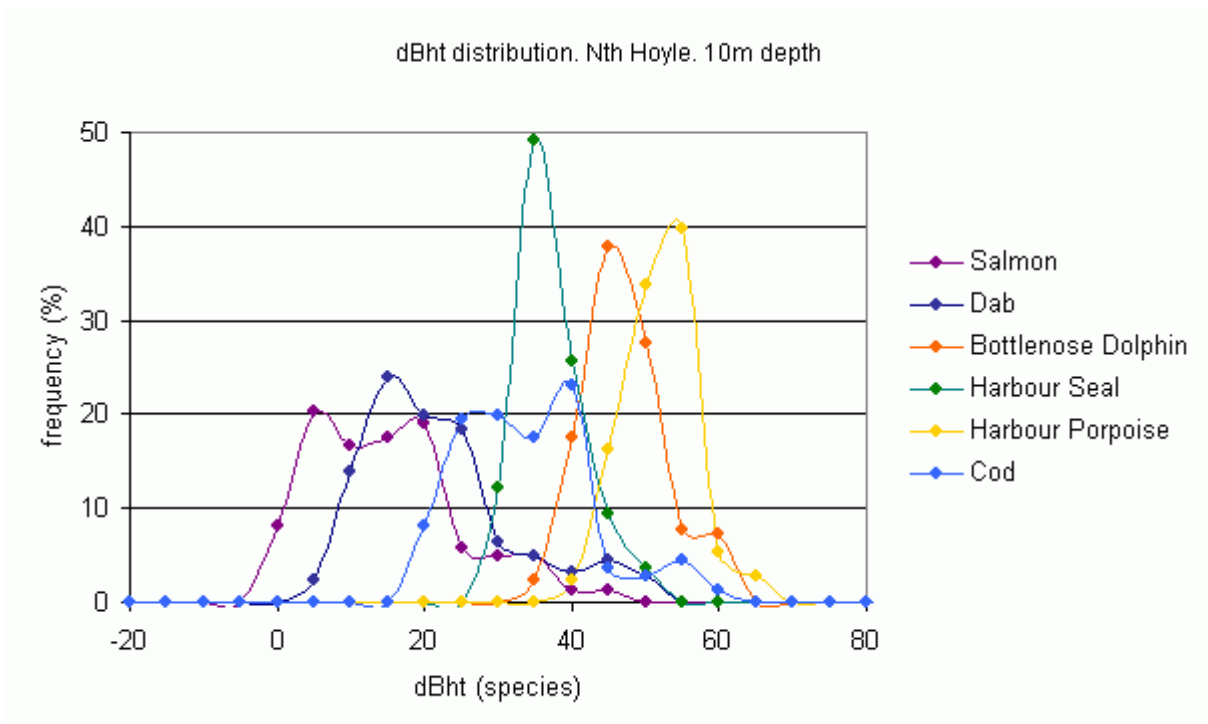

Figure 14. The distribution of dB_{ht} levels for all measurements of background noise taken at 10 m depth at North Hoyle, produced from the same data set as Figure 11.

The fish are low frequency hearers, and hence it may be seen that the variability in the low frequency noise spectrum is reflected in the variability of the perceived levels for them. By comparison, the marine mammals hear at high frequency; the variability as noted in section 5.1 is less at these frequencies and consequently it will be noted that the variability in the dB_{ht} levels is correspondingly low.

Comparison of Figures 13 and 14 shows that the results for marine mammals at 5 m depth and 10 m depth are virtually identical. The results for the fish are very similar, although it may be seen that the levels are slightly lower in the case of 10 m depth.

In all cases the existing background noise is not greatly above the threshold of hearing of the animals. The highest dB_{ht} level measured, of 53 dB_{ht} (*Phocoena phocoena*) for the harbour porpoise, is similar to the level that humans would perceive in an office environment. It may be concluded that most of the species would perceive the environment as being relatively quiet and equivalent to perhaps a typical rural night time background for humans, of the order of 20 - 40 dB(A).

In summary,

1. the estimates of the dB_{ht} (perceived) levels of the ambient noise indicate that the three marine mammals perceive a higher level of ambient noise, associated with low variability, than the three fish species, which perceive greater variability.
2. The porpoise perceives the highest level, of 53 dB_{ht} (*Phocoena phocoena*). This would compare to, for instance, the level of background noise that humans would perceive in an office environment.
3. In all cases, the species considered would perceive the background noise environment as being relatively quiet, and generally equivalent to the perception for humans of a typical rural night time background of 20 - 40 dB(A).

5.3 North Hoyle: Noise from the Douglas Facility

The term “background noise” can include both noise created by natural physical processes, such as wave and bubble noise, and noise created by pre-existing man-made sources, such as shipping. It is possible to rate the additional noise created by the construction and operation of a windfarm with pre-existing man-made noise sources.

While measurements were being taken at North Hoyle it was noted that noise from the nearby *Douglas* oil and gas facility, owned by BHP Billiton and situated to the north-east of the North Hoyle windfarm site, was present in some of the measurements. The levels from the *Douglas* facility, comprising the platform and its support vessels, could be heard during some of the measurements made around the windfarm site.

Figure 15 shows a typical time history of noise 500 m from the *Douglas* facility, with a supply vessel present and the guard ship *Grampian Supporter* about 2000 m away; the level is 134.7 dB re 1 µPa. The spectrum of this time history is illustrated in Figure 16; the mean noise spectrum from the North Hoyle site is also presented on the plot. It may be seen that the level of sound recorded from the platform is significantly above the level of background noise; audibly the noise was described as “sounding like machinery noise” with strong tonal components which can be seen on the spectra.

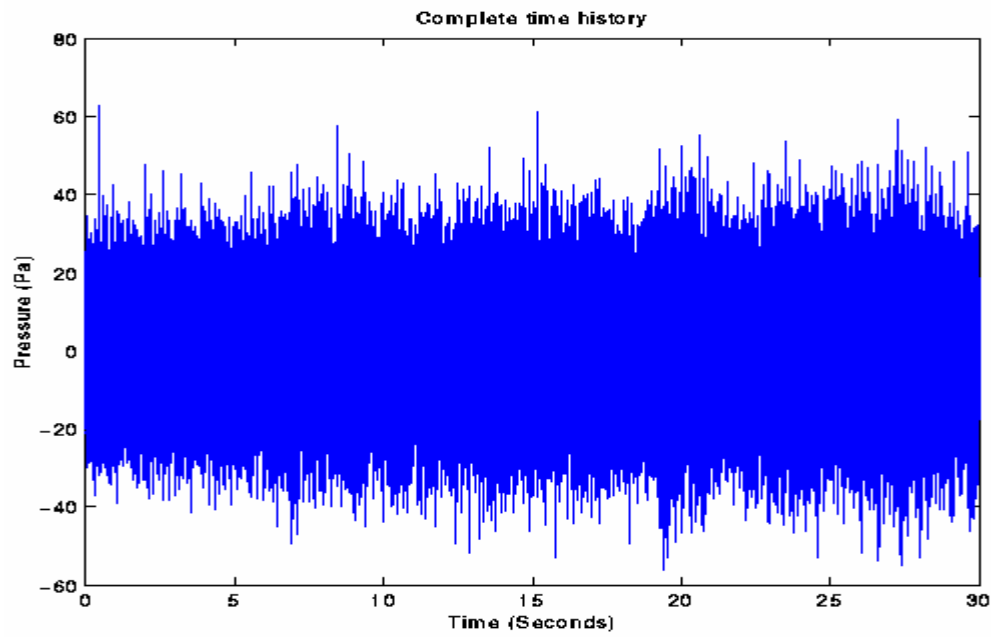

Figure 15. A typical time history of noise 500 m from the *Douglas* facility, with a supply vessel present and the guard ship *Grampian Supporter* about 2000 m away. The level is 134.7 dB re 1 μ Pa.

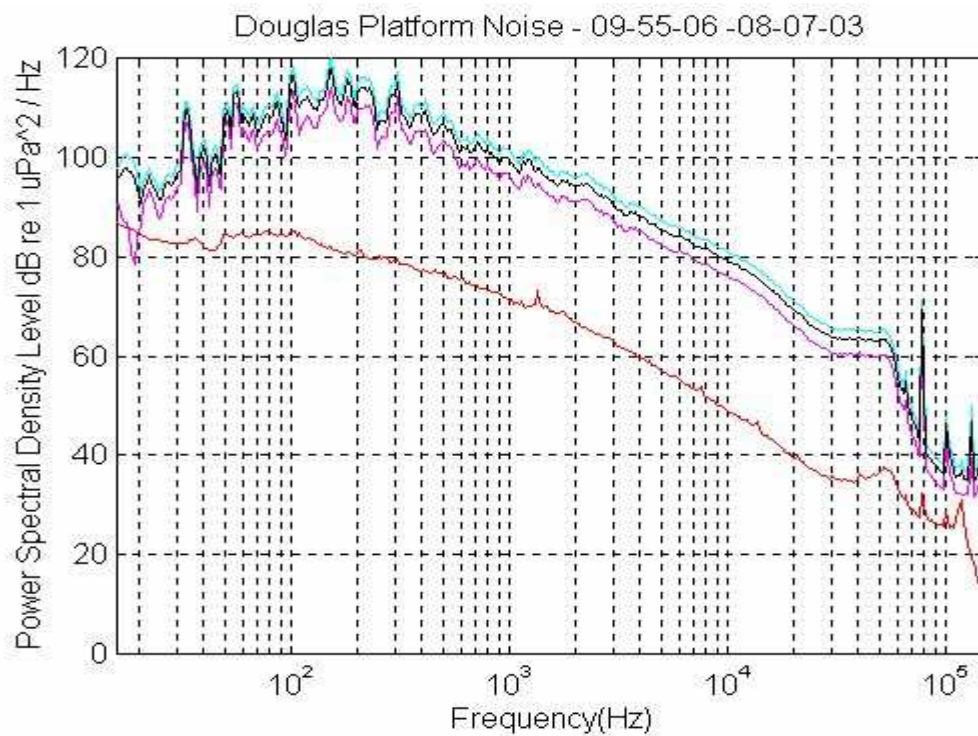

Figure 16. The power spectral density of the noise 500 m from the *Douglas* facility, illustrated in Figure 15. The brown line indicates the mean background noise level.

Measurements were taken along transects from this platform to identify the source level and transmission loss from the facility. A feature of these measurements was that it was apparent that the noise level from the facility varied significantly from time to time.

A transect taken on the 30th May 2003, with the support vessel the *Grampian Supporter* in close proximity to the platform, is illustrated in Figure 17. The figure illustrates the sound pressure level in dB re 1 μ Pa vs the range in metres, at a depth of 5 m. Indicated on the figure is the best fit of Source Level and Transmission Loss to the data.

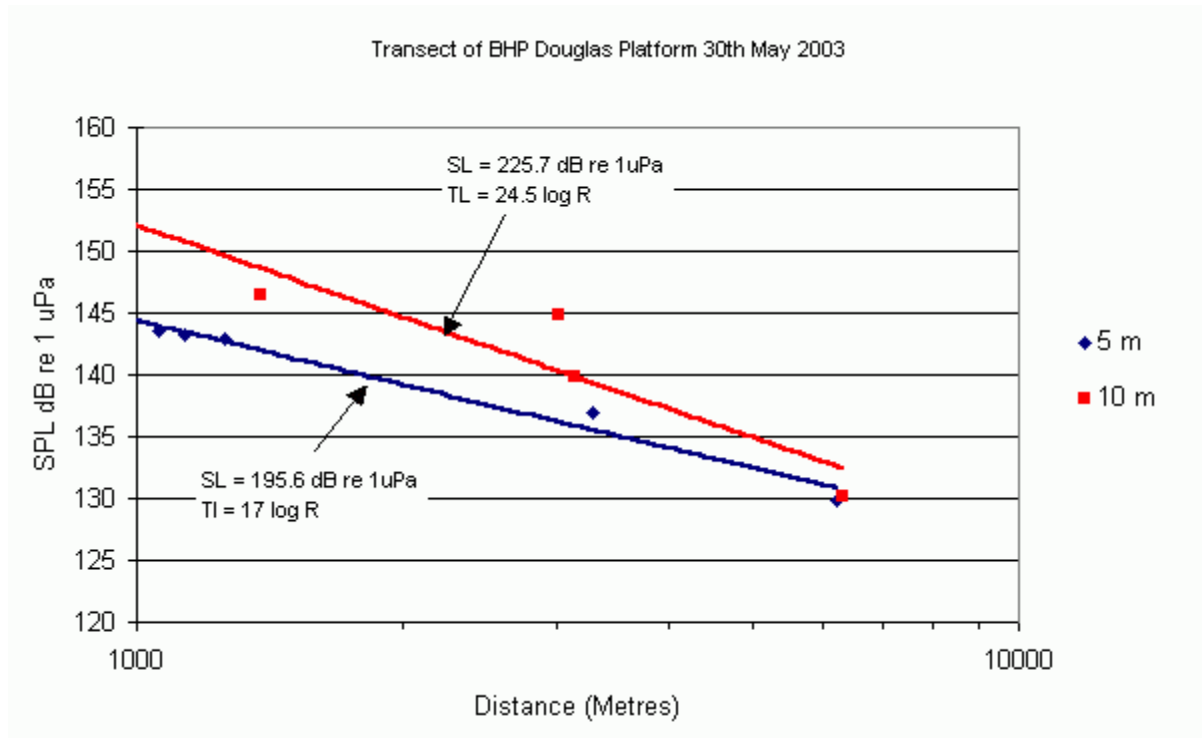

Figure 17. A transect indicating SPL vs range for measurements of noise from the *Douglas* facility.

It may be seen that the set of measurements at 5 m depth fit well to a line indicating a Source Level of 195.6 dB re 1 μ Pa @ 1 metre and a Transmission Loss of 17 log(R); those at 10 metres depth yield 225.7 dB re 1 μ Pa @ 1 metre and 24.5 log(R) respectively.

In summary:

1. noise from the nearby *Douglas* oil and gas facility was present in some of the background noise measurements, and was found to vary significantly from time to time.
2. A transect, recorded at 5 m depth on the 30th May 2003, with the *Grampian Supporter* in close proximity to the platform, indicated a Source Level of 195 dB re 1 μ Pa @ 1 m and a Transmission Loss of 20 log(R), and 225.7 dB re 1 μ Pa @ 1 metre and 24.5 log(R) at 10 metres depth respectively.

6 Construction noise measurements

This section presents measurements of man-made noise during construction. The measurements concentrated on piling, which was identified as a priority for measurements early in the program.

The windfarms at North Hoyle and Scroby Sands use monopile turbine support structures, in which the turbine is supported on a single large pile that is driven into the seabed.

Impact piling is performed by first inducing downward velocity in a heavy metal ram. Upon impact with the pile the ram creates a force far larger than its weight, which moves the pile an increment into the ground. Some impact hammers have a cushion, typically of hardwood, under the end of the ram that receives the striking energy of the hammer. This cushion is necessary to protect the striking parts from damage; it also modulates the force-time curve of the striking impulse and can be used to match the impedance of the hammer to the pile, increasing the efficiency of the blow.

In the initial stages of construction the pile is typically driven as far as possible by impact piling. If the sediment compacts such that the pile will not advance, or if the pile encounters hard rock, an internal drill is used to remove the obstruction prior to further driving taking place.

The seabed substrate at North Hoyle consists mainly of hard rock and sediment and therefore the program required a three-stage approach to the installation of turbine support structures. In brief, this involved an initial period of impact hammering to drive the pile to half depth, followed by a period of about 20 hours of drilling using a drill head lowered inside the pile. The pile was then hammered to its final depth in the final stage. The seabed at Scroby Sands, however, consists mainly of sand, and thus in this case there was no requirement for drilling during the turbine installation procedure.

6.1 Piling at North Hoyle

6.1.1 Measurements of piling at North Hoyle, conventional units.

The North Hoyle programme involved driving 30 piles over a period of about five months. The piles had a diameter of 4 m, a wall thickness of 35 mm, a weight of about 270 tonnes and a nominal length of 50 m. They were driven using a Menck MHU500T piling hammer. The average impact energy used to drive the piles was 450 kNm and the average number of blows per minute was 35.

Figures 18, 19 and 20 show time histories of piling noise measured at 955 m, 1881 m and 3905 m from the piling respectively, and at a depth of 5 m. The vertical scale represents the pressure level in Pascals; the horizontal axis represents time in seconds.

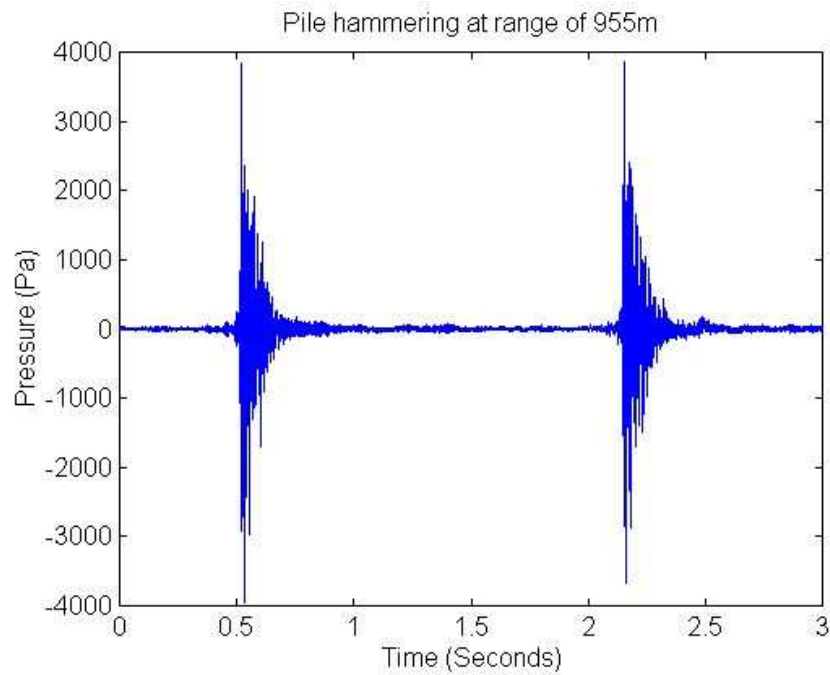

Figure 18. The time history of pile hammering recorded at 955 m at North Hoyle, 5 m below the water surface.

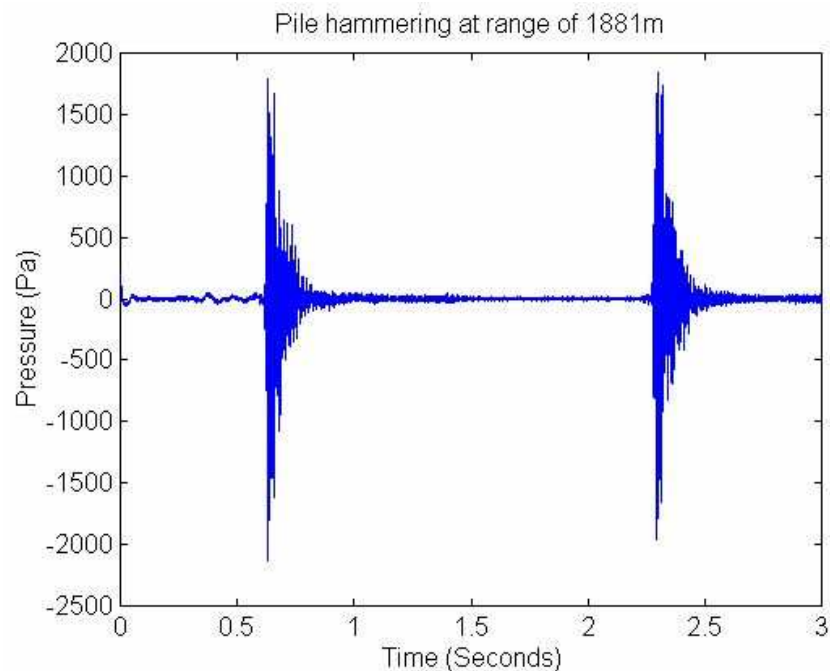

Figure 19. The time history of pile hammering recorded at 1881 m at North Hoyle, 5 m below the water surface.

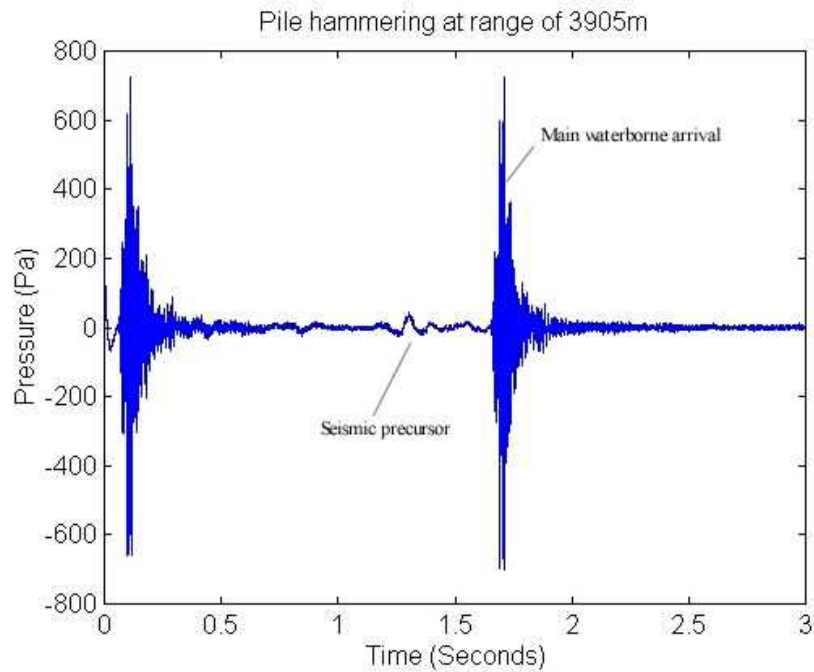

Figure 20. The time history of pile hammering recorded at 3905 m at North Hoyle, 5 m below the water surface.

In all cases it can be seen that while the peak pressure falls as range from the piling increases, the pressure impulse of the pile strike is greatly in excess of the background noise levels at all ranges. It may be seen that the level is high, having peak-to-peak levels of 184 dB re 1 μ Pa, 192 dB re 1 μ Pa and 198 dB re 1 μ Pa respectively. The piling noise is characterised by a first waterborne impulse having a rapid rise to a maximum level, followed by a ringdown period of about $\frac{1}{2}$ second. It was noted that faint “echoes” could be detected following the direct arrival; these were thought to be due to seismic (substrate-borne) arrivals. At the larger ranges, a seabed borne wave could be detected arriving shortly before the main arrival.

Figure 21 shows the $\frac{1}{27}^{\text{th}}$ octave smoothed power spectral densities of the same measurements. It can be seen that:

1. most of the energy is between 40 Hz and 1 kHz and that the spectral content of the signal does not change appreciably with range;
2. there are some tonal features evident at 200, 250, 600, 800 and 1600 Hz, which are common to each of the measurements.

Figure 22 is a spectrogram of the measurement taken at 955 m, and shows the variation of frequency content with time for frequencies up to 25 kHz over a period of 1.5 seconds. It is useful for identifying the contributions of different transmission paths and sources to the overall level.

The main waterborne arrival of the pile strike noise is marked as "2" in the figure. This is characterised by the arrival of a wide range of frequencies, with the highest frequencies decaying most quickly and the lower frequencies decaying more slowly. There is evidence of head waves, or seismic precursors (marked "1"), arriving before the main waterborne arrival; these can arrive before the waterborne arrival as the speed of sound through the substrate is greater than through water. Following the waterborne wave there are further seismic or waterborne arrivals, marked "4" in the figure. The same tonal components found in Figure 21 may be seen; these result in horizontal lines (i.e. at constant frequency) at approximately 200, 250, 600, 800 and 1600 Hz, which are marked "3" in the figure and could be heard as 'ringing'

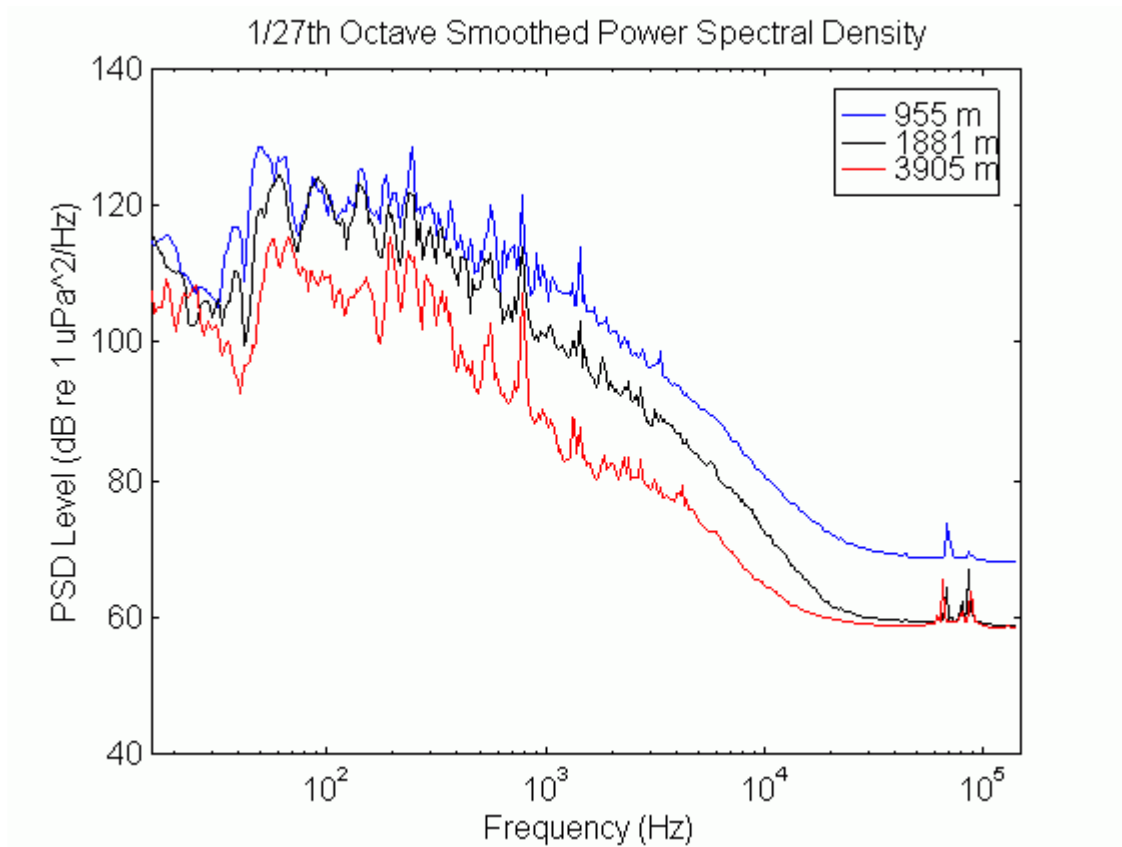

Figure 21. Plots of power spectral densities for the three measurements of pile hammering presented in Figures 18, 19 and 20.

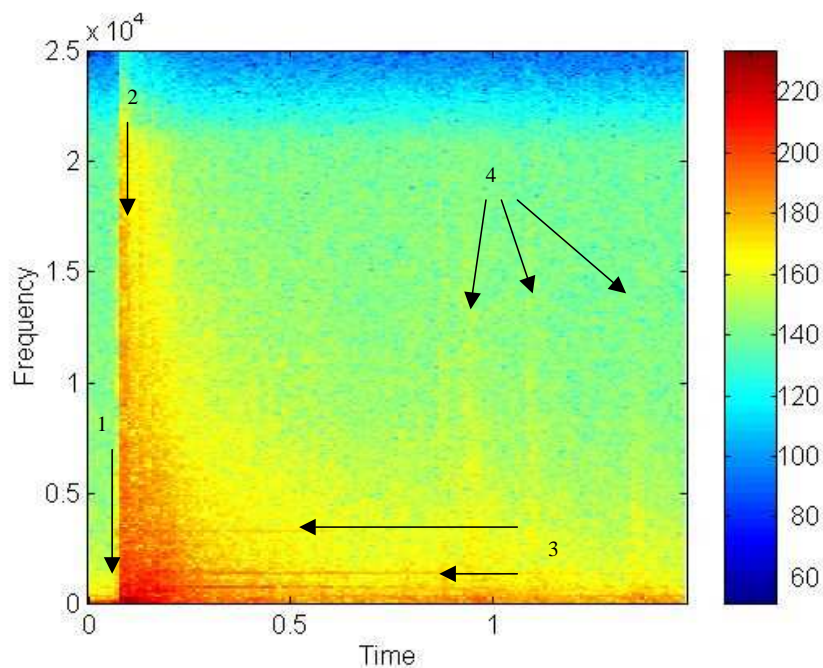

Figure 22. A spectrogram of a single impact at a range of 955 m from the source. The vertical scale represents frequencies to 25 kHz, the horizontal axis represents time to 1.5 seconds. Colours represent spectral levels from 40 to 220 dB re 1 $\mu\text{Pa}^2/\text{Hz}$.

of the pile following the strike. These are thought to be due to resonances of the steel pile.

Figure 23 illustrates the same data as Figure 22, but over a wider frequency range of up to 150 kHz. It may be seen that there is a significant energy component up to at least 100 kHz. This is of significance since many marine mammals have hearing ranges which extend up to these frequencies.

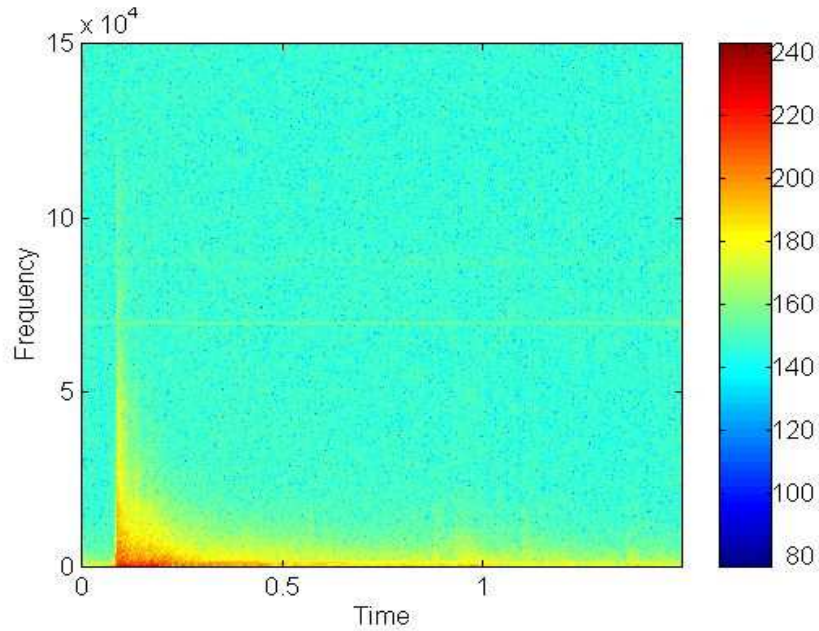

Figure 23. A spectrogram of a single impact measured at a range of 955 m from the source; as Figure 22 but with frequencies to 150 kHz.

Figures 24 and 25 show spectrograms of the measurements taken at 1881 m and at 3905 m, for frequencies up to 25 kHz. The ringing and reflections are still evident, but less pronounced at these greater ranges.

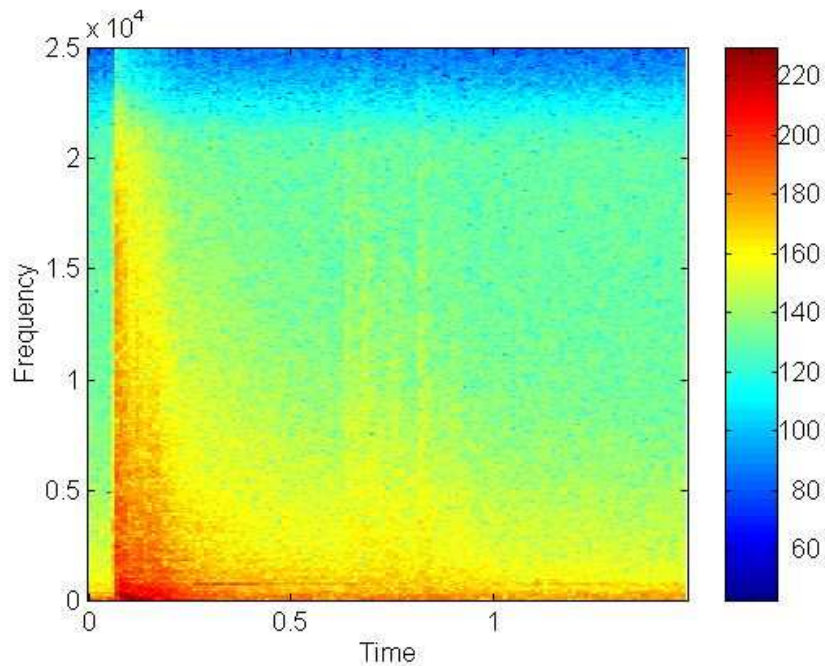

Figure 24. A spectrogram of a single impact at a range of 1881 m from the source. The vertical scale represents frequencies to 25 kHz, the horizontal axis represents time to 1.5 seconds. Colours represent spectral levels from 40 to 220 dB re 1 μPa²/Hz.

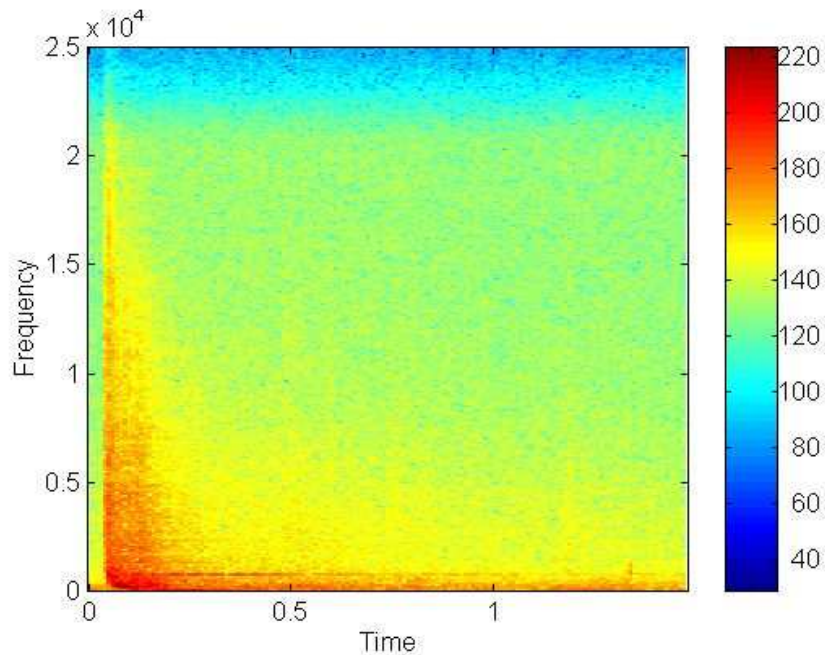

Figure 25. A spectrogram of a single impact at a range of 3905 m from the source. The vertical scale represents frequencies to 25 kHz, the horizontal axis represents time to 1.5 seconds. Colours represent spectral levels from 40 to 220 dB re 1 μPa²/Hz.

Figure 26 shows the measured peak pressures from the North Hoyle pile hammering measurements plotted against range. Since each recording at each position contained many pile strikes, the average of the peak pressures over a record has been plotted, on average about 22 pile strikes. In fact, the individual pile strike levels were relatively constant. The measurements show that the level of noise falls evenly with range in all directions, i.e. there are no preferential directions for propagation of noise.

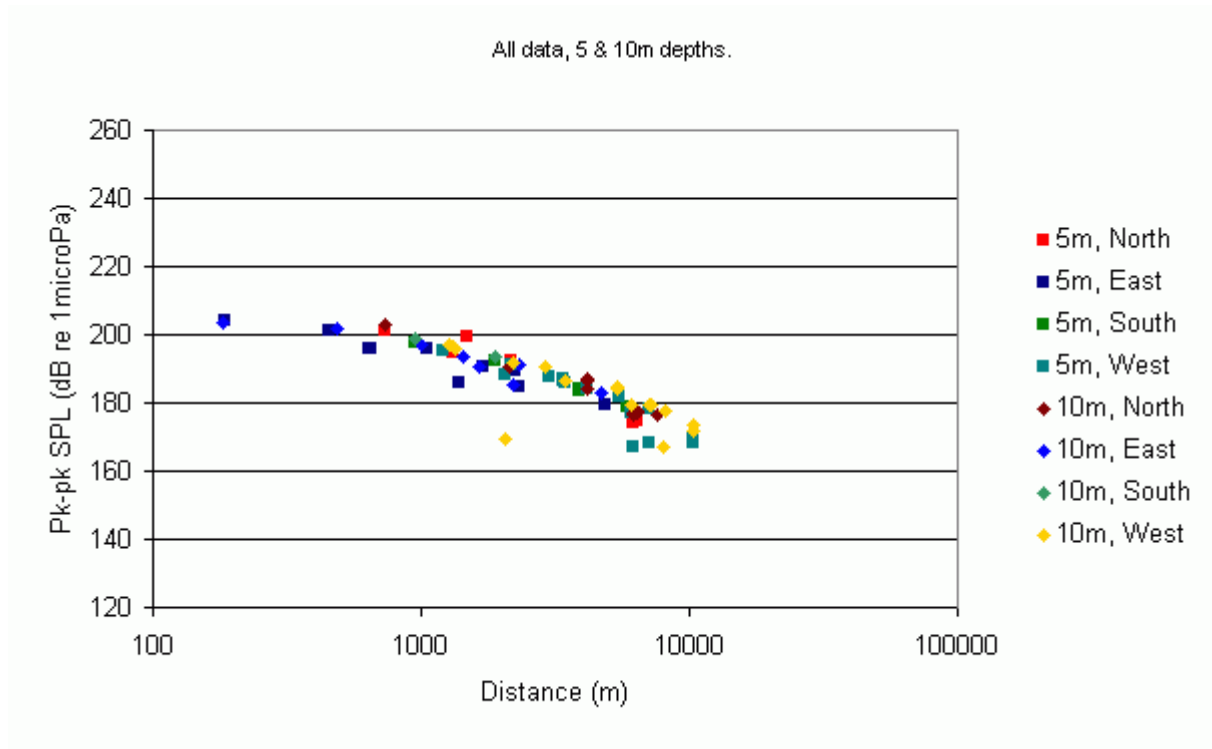

Figure 26. The peak-to-peak SPL of the piling vs range for all measurements (all transects, 5 and 10 m depth) of pile hammering at North Hoyle.

In order to quantify the measurements and to provide generic information that may be used in future estimates of environmental effect, Transmission Loss (TL) and Source Level (SL) models have been fitted to the measured peak pressures from the source as a function of range. These are essentially a best fit line through the data; the SL is effectively the level at a range of 1 m and the TL represents the gradient of the line. A further explanation of SL and TL is given in Appendix A.

Figure 27 presents the peak pressure measured at 5 m depth from the North Hoyle pile hammering measurements, and the fit of a SL-TL model to the data. The model indicates that the effective Source Level of the piling noise is 260 dB re 1 μ Pa @ 1 m. The corresponding Transmission Loss is given by $22 \log(R)$, where R is the range. The latter value of TL is similar to values that have been found for a variety of other noise sources.

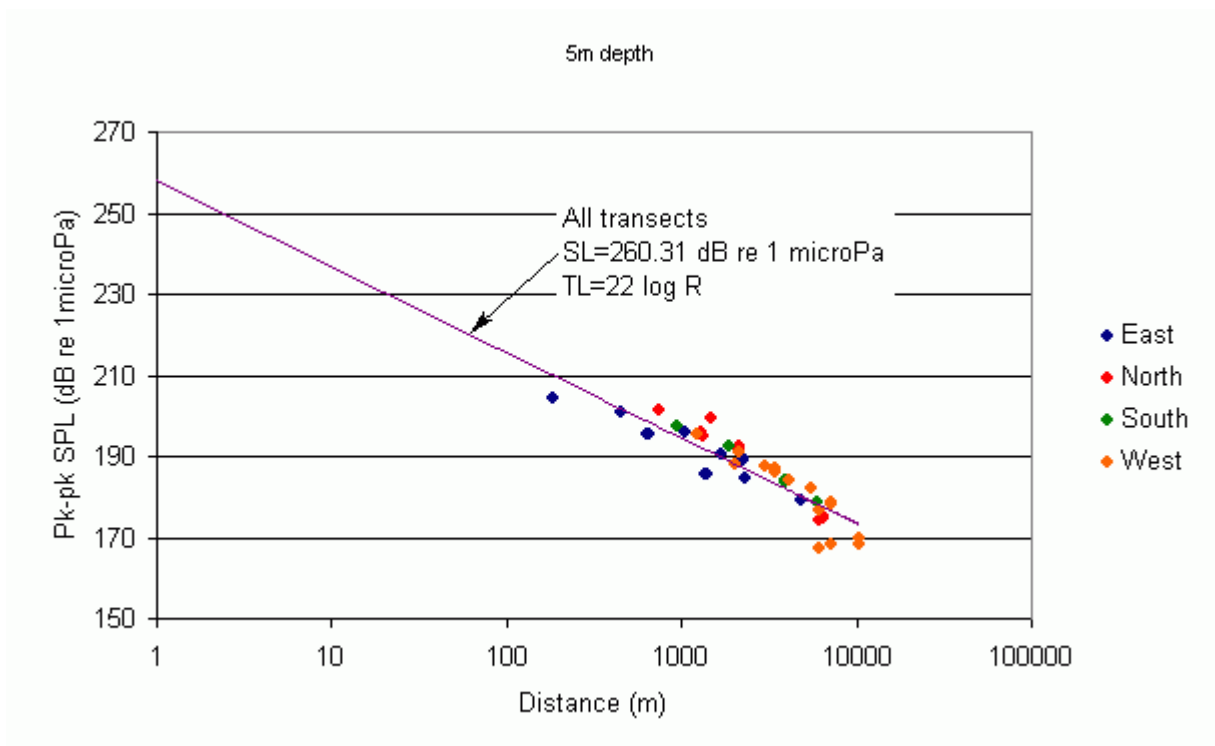

Figure 27. The peak-to-peak SPL of the piling vs range for all measurements of pile hammering at North Hoyle, at 5 m depth.

A similar Transmission Loss may be calculated for the results at 10 m depth, plotted in Figure 28; the Source Level is in this instance slightly higher at 262 dB re 1 μ Pa @ 1 m.

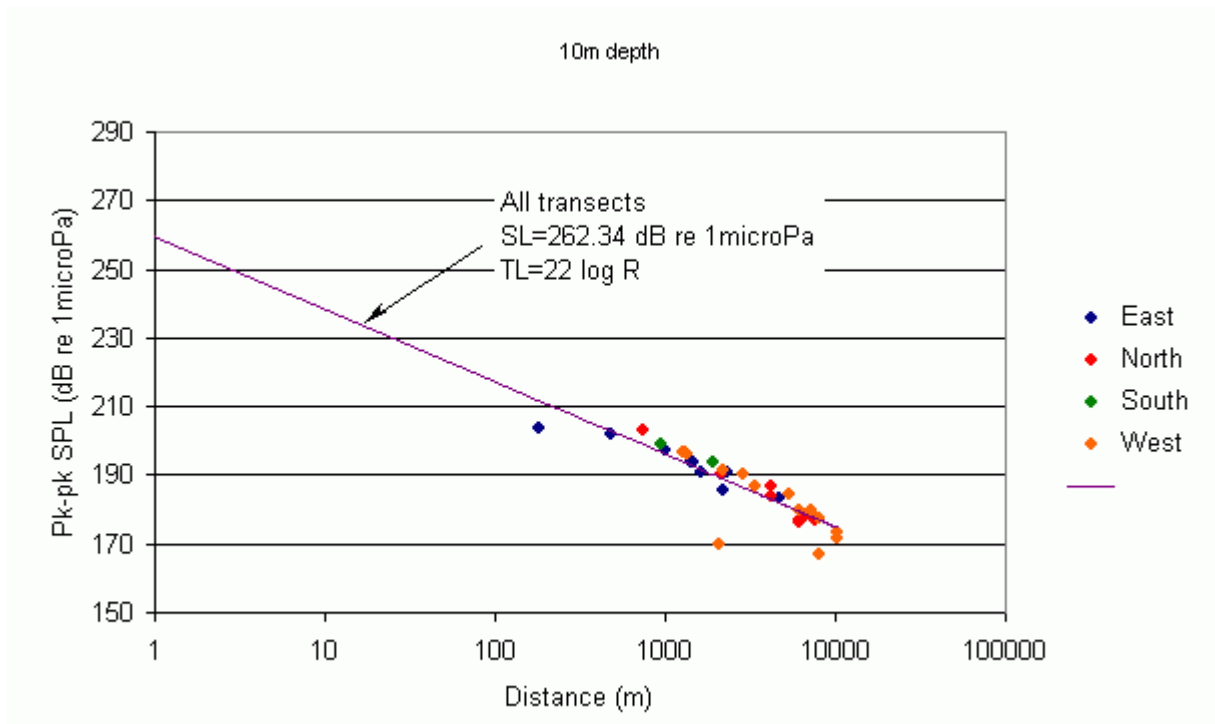

Figure 28. The peak-to-peak SPL of the piling vs range for all measurements of pile hammering at North Hoyle, at 10 m depth.

In summary, the unweighted North Hoyle pile hammering measurements show that

1. the effective Source Level of the piling noise measured at 5 m depth is 260 dB re 1 μ Pa @ 1 m, and 262 dB re 1 μ Pa @ 1 m at 10 m depth. The corresponding Transmission Loss is given by 22 log (R), where R is the range.
2. the level of noise falls evenly with range in all directions, i.e. there are no preferential directions for propagation of noise.

6.1.2 Measurements of piling at North Hoyle, dB_{ht} units.

Figures 29 and 30 illustrate the calculated dB_{ht} levels for the measurements of piling at North Hoyle, at 5 m depth and 10 m depth respectively. On each figure the levels have been plotted for three species of marine mammals and three species of fish. For each species, the corresponding Source Level and Transmission Loss have been calculated; they are plotted on the figure and the values appended in the table attached to the figure. Also illustrated on the figure is a level of 90 dB_{ht}, which has been suggested as a threshold at which a “significant avoidance reaction” will occur.

About 75% of the measurements are in excess of this value, indicating that significant avoidance reaction by a range of species would be likely at the ranges at which measurements were made of up to 10 km. The ranges at which significant avoidance reaction would be expected, based on a criterion of 90 dB_{ht}, have been calculated from this data and are tabulated in Table 2 below.

Table 2. Calculated ranges for significant avoidance reaction as a function of species.

Species	Calculated range for significant avoidance reaction
Salmon	1400 m
Cod	5500 m
Dab	1600 m
Bottlenose Dolphin	4600 m
Harbour Porpoise	7400 m
Harbour Seal	2000 m

It may be noted that avoidance in a minority of individuals would be expected at lower levels, and hence to ranges in excess of these. At closer ranges, an increasingly strong reaction would be expected; Nedwell (1998b) noted a strong avoidance reaction (by at least 80% of individuals) at a level of 98 dB_{ht} which would correspond to ranges of 50% of those indicated in the table.

Nedwell and Howell (2004a) present a review of available information on the effects of underwater noise from windfarms, which includes information on piling. It is noted that in the only direct observation of the reaction of harbour porpoises to offshore piling for windfarms, by Tougaard *et al* (2003), the short-term effects of the construction of wind turbines on harbour porpoises at Horns Reef in Denmark were monitored by passive acoustic monitoring and Marine Mammal Observers (MMOs). The authors concluded that impact piling reduced the activity of harbour porpoises in the entire Horns Reef area, at ranges of up to 15 km from the piling. Since the criterion used in the analysis of the North Hoyle data was for “significant avoidance reaction” a milder reaction would be expected to greater ranges,

and hence the conclusions of the analysis presented above and the data presented by Tougaard are consistent.

Further work is required to confirm these effects, and to document the range and dB_{ht} levels of sound at which they occur.

In summary, the North Hoyle pile hammering measurements in dB_{ht} units show that

1. About 75% of the measurements are in excess of a value of $90 \text{ dB}_{\text{ht}}$, indicating that significant avoidance reaction by a range of species would be likely, and
2. behavioural effects (avoidance behaviour) of both marine mammals and fish could occur at several kilometres from the piling.

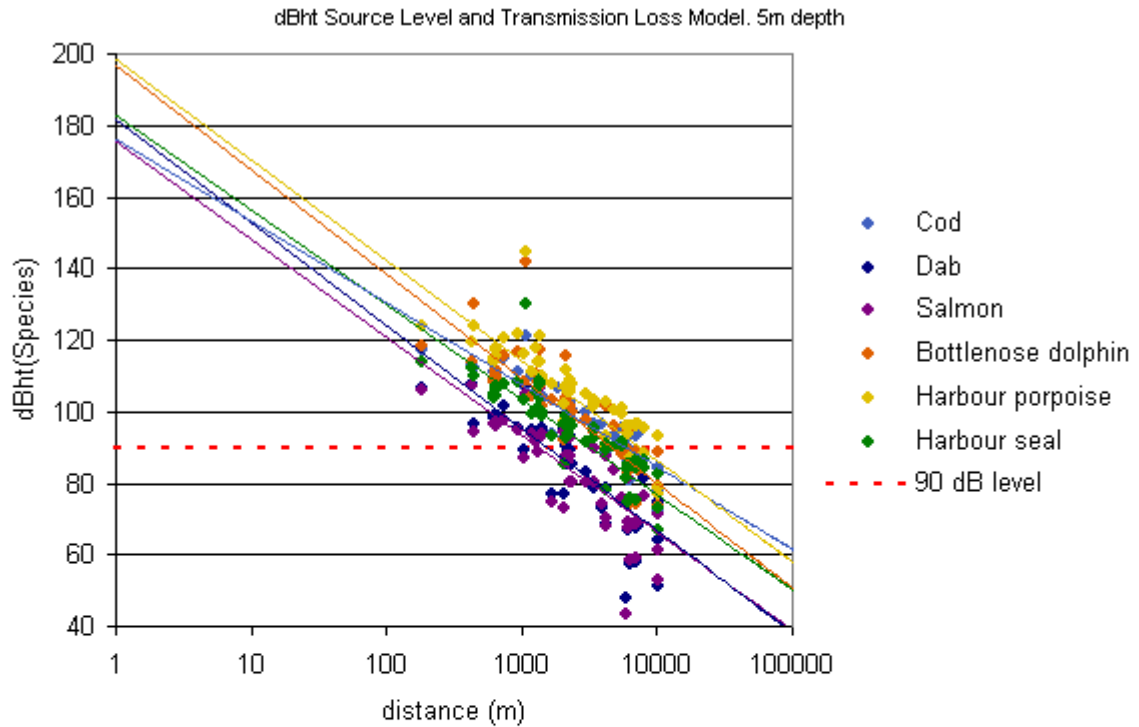

Fits of Source Levels and Transmission Losses to data for species

<p>Cod SL = 176.5 dBht(<i>Gadus morhua</i>) TL = 23.0 log(R)</p>	<p>Bottlenose dolphin SL = 196.9 dBht (<i>Tursiops truncatus</i>) TL = 29.2 log(R)</p>
<p>Dab SL = 181.9 dBht(<i>Limanda limanda</i>) TL = 28.7 log(R)</p>	<p>Harbour porpoise SL = 198.8 dBht(<i>Phocoena phocoena</i>) TL = 28.1 log(R)</p>
<p>Salmon SL = 175.9 dBht(<i>Salmo salar</i>) TL = 27.4 log(R)</p>	<p>Harbour seal SL = 183.0dBht(<i>Phoca vitulina</i>) TL = 26.5 log(R)</p>

Figure 29. The dB_{ht} levels of the pile hammering noise measurements at 5 m depth, and SL and TL models for various species

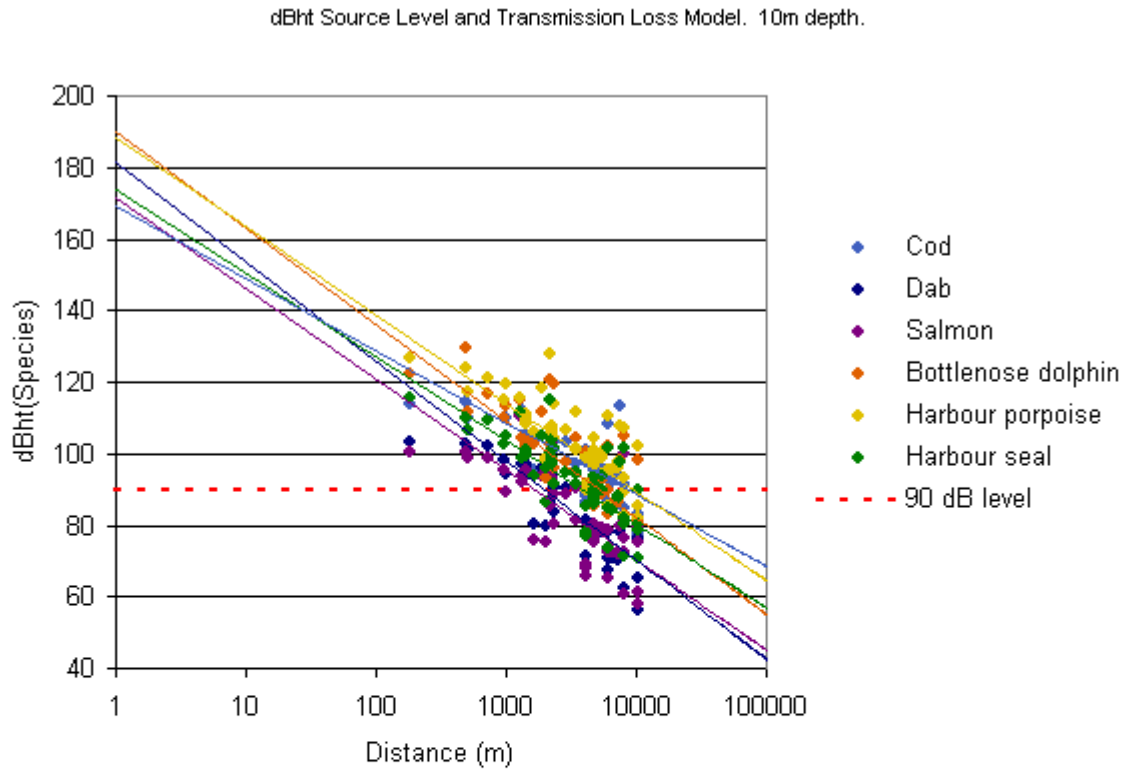

Fits of Source Levels and Transmission Losses to data for species

<p>Cod</p> <p>SL = 169.11 dBht (<i>Gadus morhua</i>)</p> <p>TL = 20.0 log(R)</p>	<p>Bottlenose dolphin</p> <p>SL = 190 dBht (<i>Tursiops truncatus</i>)</p> <p>TL = 26.7 log(R)</p>
<p>Dab</p> <p>SL = 181.3 dBht (<i>Limanda limanda</i>)</p> <p>TL = 27.7 log(R)</p>	<p>Harbour porpoise</p> <p>SL = 188.13 dBht (<i>Phocoena phocoena</i>)</p> <p>TL = 24.7 log(R)</p>
<p>Salmon</p> <p>SL = 171.2 dBht (<i>Salmo salar</i>)</p> <p>TL = 25.2 log(R)</p>	<p>Harbour seal</p> <p>SL = 173.6 dBht (<i>Phoca vitulina</i>)</p> <p>TL = 23.3 log(R)</p>

Figure 30. The dB_{ht} levels of the pile hammering noise measurements at 10 m depth, and SL and TL models for various species

6.1.3 Measurements of piling at North Hoyle; possible physical effects of piling noise on fish

In northern California caged Pacific salmon (*Onchorhynchus spp.*) were held at various distances from pile driving being undertaken for a major road crossing (Abbott (2002)). At close range injuries of the type described above were observed. The kill range for young salmon was estimated at 700 m, and significant fish mortality was noted during the programme. The piles were half the size of those used in the North Hoyle project (2.4 m dia. cf. 4 m dia). The measured noise levels for the piles being driven (without any attenuation measures being taken) are shown in Table 3.

It is interesting to convert these values to a source level (SL) using the same transmission loss (TL) as used in the North Hoyle results. In this case, a SL of 247 to 257 dB re 1 μ Pa @ 1 m results for the measurements at 103 m, and 249 to 259 dB re 1 μ Pa @ 1 m for the results at 358 m. This implies both that the scaling is appropriate, because it gives similar source levels from results at two different distances. Since the Source Level of the North Hoyle piling is higher than this figure, the level of noise from the piling at North Hoyle is probably sufficient to cause local fish kill.

Table 3. Measured peak sound pressure levels as a function of range, (from Abbott (2002)).

Distance between pile driving and measurement locations (m)	Peak sound pressure level (dB re 1 μ Pa)
103	197 – 207
358	181 - 191

It may be questioned whether there is any possibility of injury to marine mammals in the vicinity of the piling.

Figures 31 and 32 illustrate the impulse level of the noise from the piling at North Hoyle as a function of range. The impulse Source Level of the piling is 212 dB re 1 μ Pa.s @ 1 metre at a depth of 5 m associated with a Transmission Loss of 26 log (R); at 10 m depth the equivalent quantities are 202 dB re 1 μ Pa.s @ 1 metre and 22 log (R).

Yelverton *et al.* (1972) noted that 163 dB re 1 μ Pa.s was a threshold for a high incidence of moderately severe blast injuries to marine mammals, including eardrum rupture. Use of this effect threshold in conjunction with the results implies that injury might occur within ranges of 77 m at 5 m water depth, and 60 m at 10 m water depth. The severity of the injury would be expected to increase for marine mammals at lesser ranges.

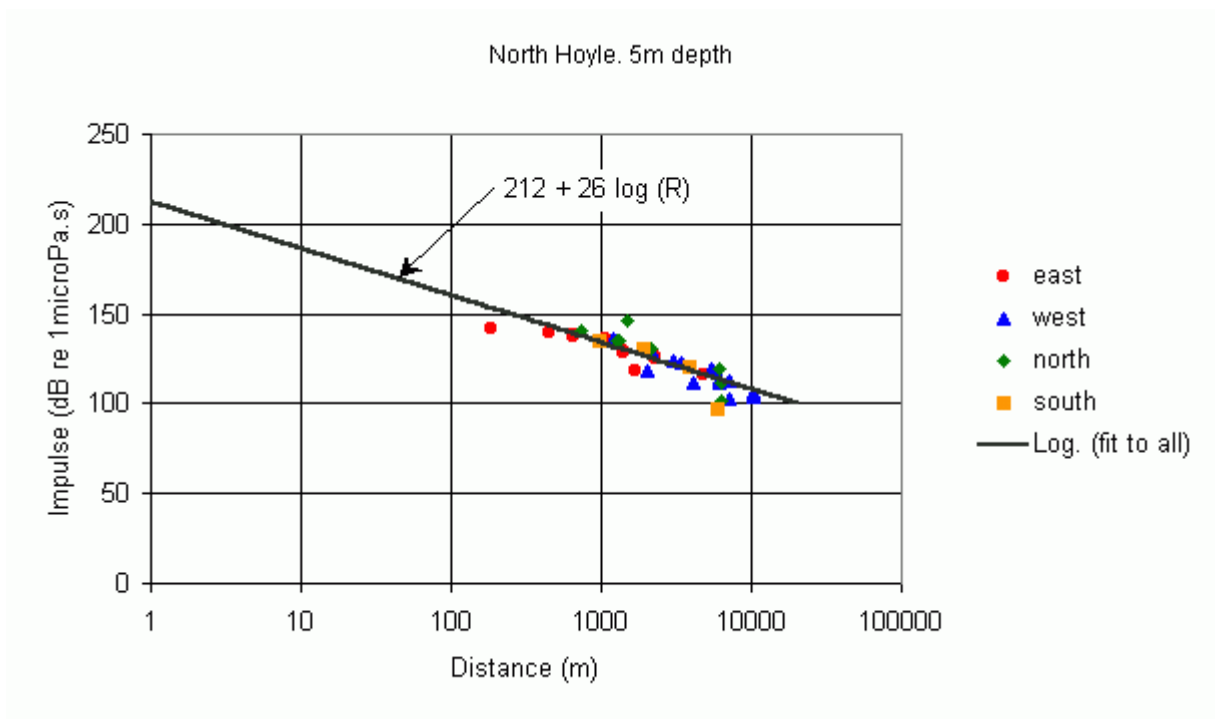

Figure 31. The measured impulse of pile hammering noise in dB re 1 μ Pa.s at North Hoyle at 5 m depth, and impulse Source Level and Transmission Loss best fit.

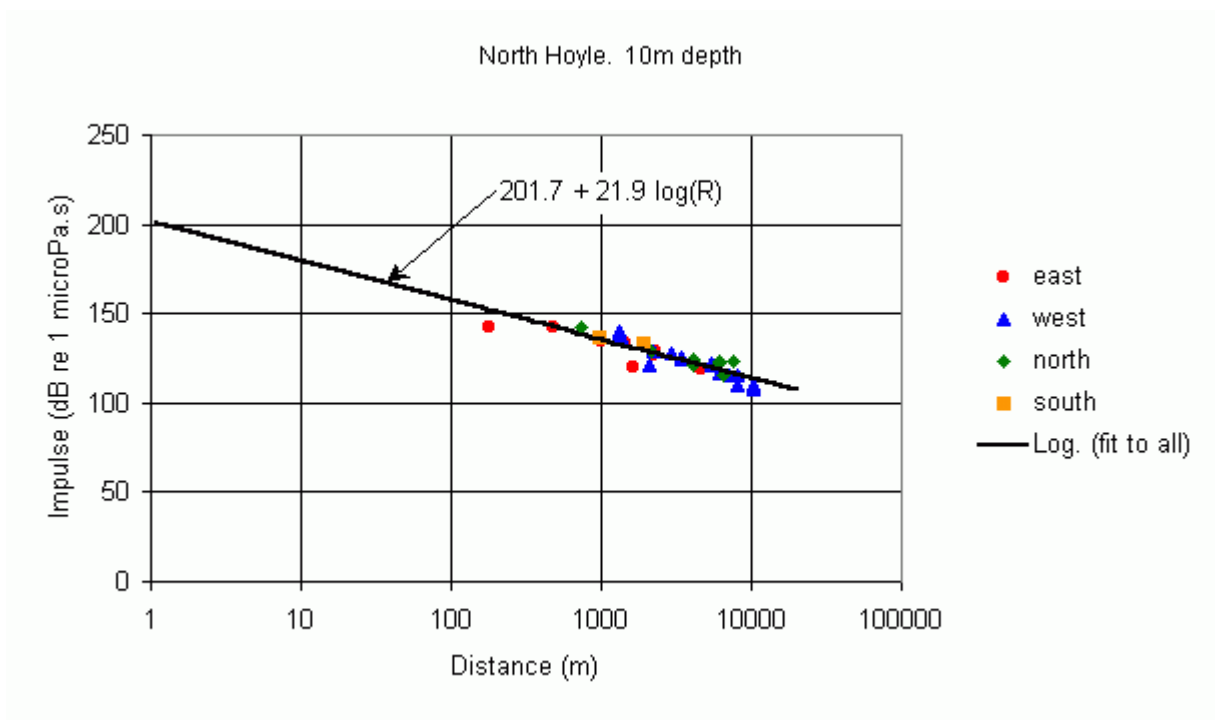

Figure 32. The measured impulse level in dB re 1 μ Pa.s of pile hammering noise at North Hoyle at 10 m depth, and Source Impulse level and Transmission Loss best fit.

In summary, the levels of sound recorded during piling were such that in the immediate vicinity of piling, say within 77 metres or so, the underwater noise could cause a high incidence of moderately severe blast-type injuries to marine mammals, including eardrum rupture.

6.2 Impact pile driving at Scroby Sands

The Scroby Sands windfarm construction program commenced late in October 2003, with the monopile foundations completed by the end of the same year. The foundation piles were installed using a single impact piling session without a requirement for rock socket drilling as at North Hoyle. Though permission was granted for the installation of 38 turbines, only 30 were installed.

The monopiles have a diameter of 4.2 m and range in length from 40 to 50 m. The piles are driven into the sand to a depth of 35 m and protrude a nominal 8 m above the sea surface. The turbine structures will, when completed, have a height of 60 m, with the blades each 39 m long.

The results of the measurements are illustrated in Figure 33. The results have been plotted over the corresponding results from North Hoyle. The best fits of Source Level and Transmission Loss have been overlaid on the results for the North Hoyle results at 5 and 10 m, and the Scroby Sands results at all depths. It may be noted that, due to the very shallow water at Scroby Sands, some of the measurements are at 1 m and 2 m depth.

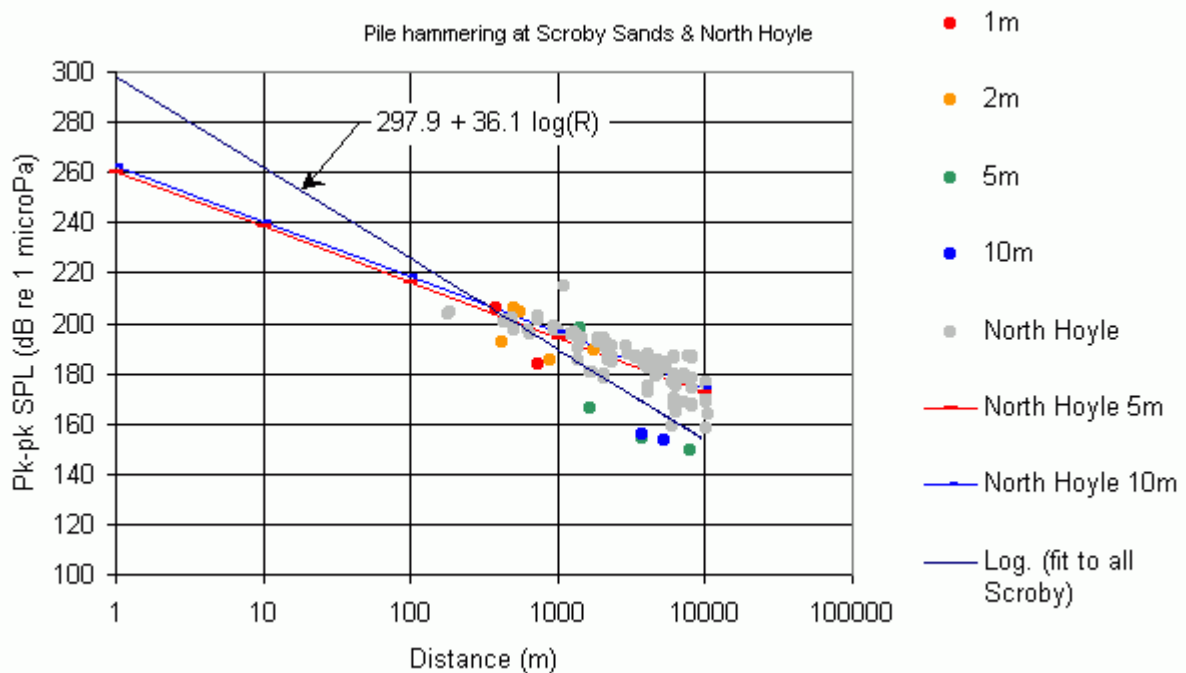

Figure 33. The peak-to-peak SPL of the piling vs range for all measurements of pile hammering at Scroby Sands, and North Hoyle.

In general, the levels are similar to those at North Hoyle. There is, however, a significant difference in that the apparent Transmission Loss is very high, at about $35 \log(R)$, associated with a high apparent Source Level of 297 dB re $1 \mu\text{Pa}$ @ 1 m. These values differ greatly from both the North Hoyle ones presented herein and also from other measurements the authors have made. It is clear that in the present case the Source Level is unrealistically high. This may partly be due to the number of measurements made at Scroby Sands being lower than for North Hoyle, such that the quality of fit of Source Level and Transmission Loss was poor. It is also probable that, had measurements been made at closer ranges, the actual levels would have been much lower than the “straight line” model would predict. The high levels probably result from the complex bathymetry of the site and very shallow water in which the

piling was conducted leading to a relatively high level at the closest ranges at which measurements were made. This could arise, for instance, from the partial focussing in the shallow water around the piling of the waterborne and seismic waves.

The result points to the importance of using this empirical information with care. Currently there is no reliable information regarding the role of the seabed and substrates in determining the noise level from piling. In addition, the piling equipment used and piling method may also have a bearing on noise level. Consequently, it may be concluded that it is not currently possible to predict the noise from piling with complete certainty.

The acoustic and geological properties of the site should be considered carefully when using empirical models to predict the level of sound that will result from a piling operation, to ensure that the model is appropriate. In cases where the acoustical, bathymetry or seabed properties are significantly different from those for which the empirical models have been developed, use of suitable acoustic and vibration modelling programs, scale models or direct measurement of transmission should be considered. In all cases, it is important to ensure that the modelling or measurements are performed in units relevant to effects on the species of interest.

Since the measurements at Scroby Sands were similar in level to those at North Hoyle, similar conclusions pertain in respect of environmental effects.

In summary, the measurements made of piling at Scroby Sands indicate that:

1. the levels are similar to those of the piling at North Hoyle, and hence similar conclusions pertain in respect of environmental effects;
2. the apparent Transmission Loss is very high, at about 35 log (R), associated with an unrealistically high apparent Source Level of 297 dB re 1 μ Pa @ 1 metre. It is unlikely that this model will provide accurate estimates of level at ranges shorter or greater than those measured;
3. the result noted in 2 above may have arisen as a result of the complex bathymetry and geology of the site, and consequently indicates that the acoustic and geological properties of the site should be considered carefully when using empirical models to predict the level of sound that will result from a piling operation, to ensure that the model is appropriate.

6.3 Cable trenching at North Hoyle

During the installation of the cables at North Hoyle measurements were made of the noise levels created by trenching of cables into the seabed.

Figure 34 presents a typical time history; recorded at a range of 160 m from the trenching with the hydrophone at 2 m depth; this was necessary because, at the time the measurements were being made, the work was being undertaken in very shallow water. The sound pressure level of this recording was 123 dB re 1 μ Pa.

The trenching noise was found to be a mixture of broadband noise, tonal machinery noise and transients which were probably associated with rock breakage. It was noted at the time of the survey that the noise was highly variable, and apparently dependent on the physical properties of the particular area of seabed that was being cut at the time.

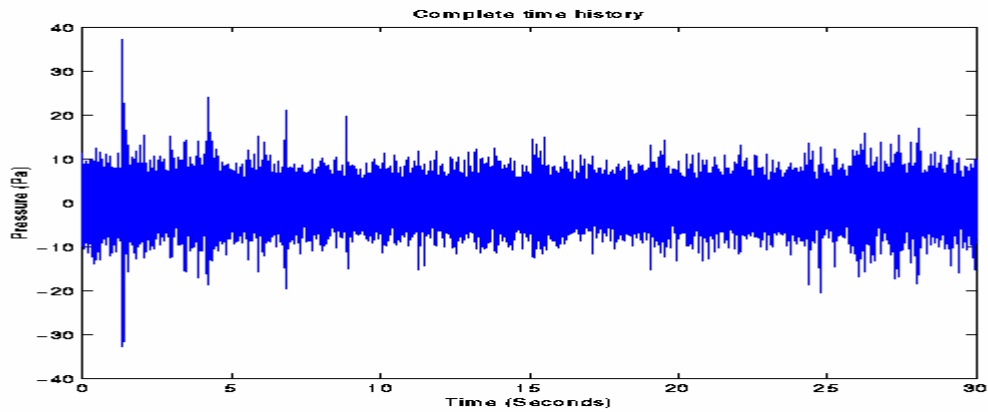

Figure 34. A typical time history of cable trenching noise, recorded at a range of 160 m with the hydrophone at 2 m depth.

Figure 35 is the power spectral density of the measurement illustrated in Figure 34. It may be seen that the spectrum is broadband, with some energy at 50 kHz and above, although in general it is only some 10 – 15 dB above the level of background noise. It is assumed that the peak in the spectrum at 40 kHz is due to the use of baseline sonar for positioning. Because of the variability of the noise it is difficult to establish the unweighted Source Level of the noise, but if a Transmission Loss of $22 \log(R)$ is assumed, a Source Level of 178 dB re 1 μPa @ 1 m results.

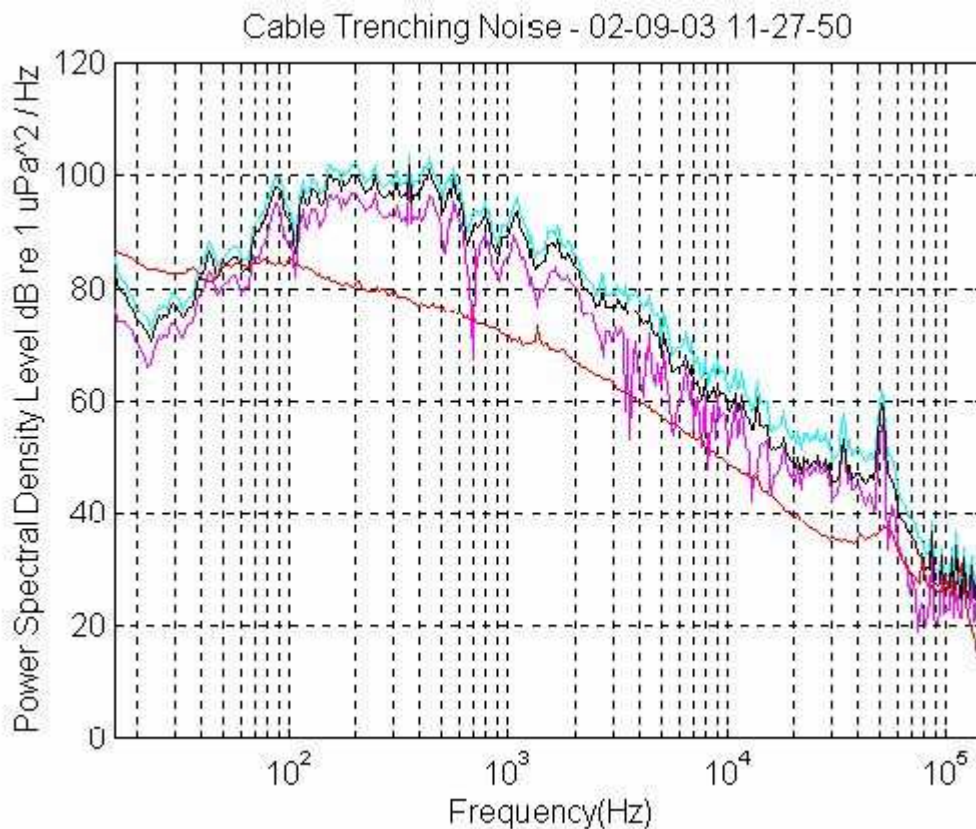

Figure 35. The power spectral density of the cable trenching noise shown in the Figure 34. The brown line indicates the mean background noise level.

Figure 36 illustrates the dB_{ht} levels of the noise as a function of range. In this case, due to the high variability of the noise, no reliable estimates of Source Level or Transmission Loss can be made. However, it may be noted that, with one exception, all of the measurements are below 70 dB_{ht} , and hence below the level at which a behavioural reaction would be expected.

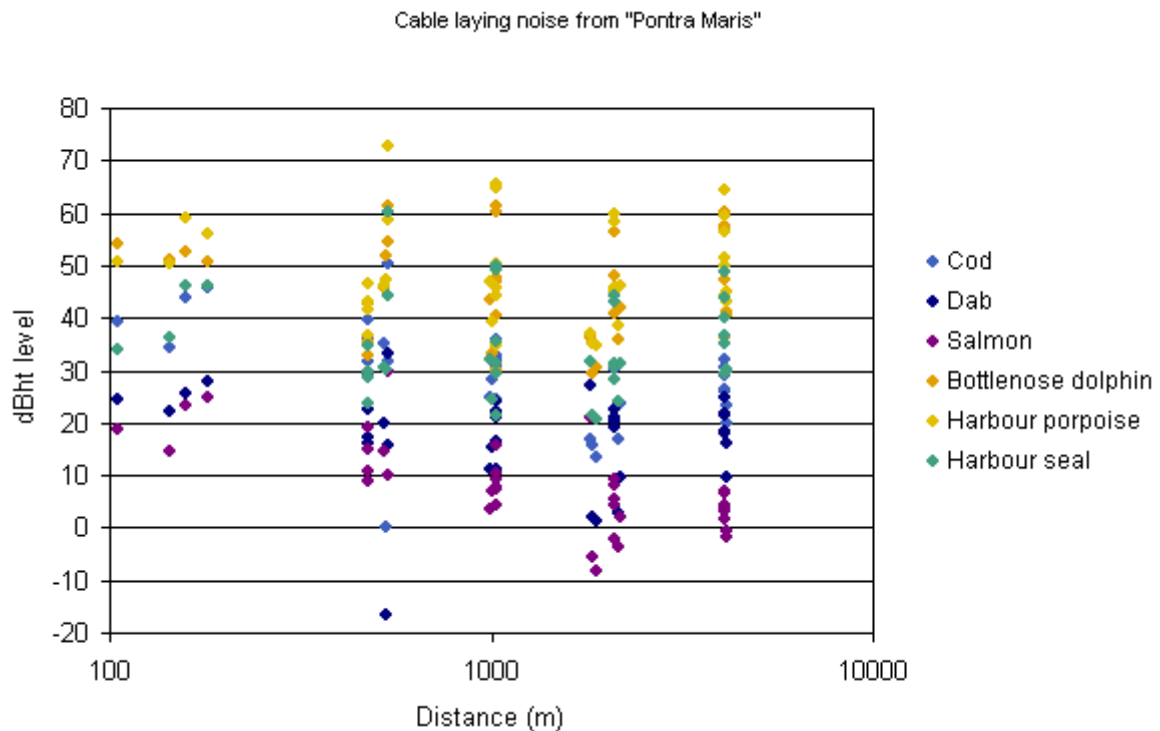

Figure 36. dB_{ht} values for six species as a function of range, for cable trenching at North Hoyle.

6.4 Rock socket drilling noise at North Hoyle

As noted in section 4.3.1, the seabed substrate at North Hoyle is mainly hard rock and sediment and, after initial impact hammering, sockets had to be drilled in the underlying sandstone for all of the piles, using a drill head within the pile. About 20 hours of drilling were required to allow each pile to be hammered to its final depth.

Figure 37 shows the time history of a typical measurement of drilling noise. The measurement was taken at a range of 160 m away from the jack-up barge *Excalibur*, which was conducting the pile installation. The time history consists mainly of tonal noise, possibly associated with meshing noise from gearbox drives.

Figure 38 illustrates the power spectral density of the measurement. The measurement is compared with the mean background noise from the North Hoyle windfarm site.

It may be seen that in general above 100 Hz there is significant tonal noise, leading to peaks in the spectrum 5 – 15 dB above the level of background noise. Strong peaks are identifiable at approximately 125, 250 and 375 Hz, but there are also lower level peaks at a wide range of frequencies. There is also evidence of tonal noise at lower frequencies, although, due to the processing used, the lower frequency peaks are not clearly visible as they have been smeared by the bandwidth of the processing (1 Hz). Some evidence of higher frequency noise swathes (narrow peaks) can also be seen at frequencies up to 8 kHz. It should be commented that although there is an apparent increase in level for frequencies of 20 kHz and above, this is due to the measurement reaching the noise floor of the recording equipment; the flat region

indicates the high frequency electrical noise floor. This could not be avoided because, even with pre-emphasis, the dynamic range was greatly increased by transients and tonal peaks.

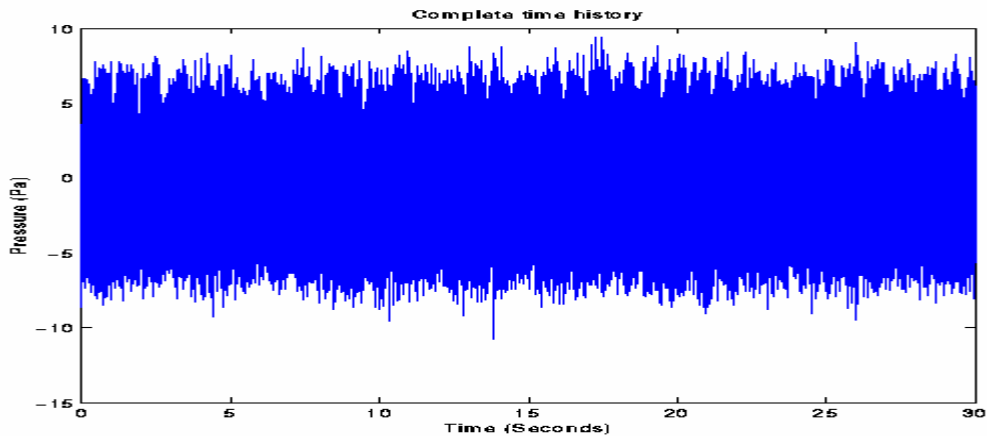

Figure 37. A typical time history of rock socket drilling noise from North Hoyle, taken at a range of 330 m with the hydrophone at 10 m depth

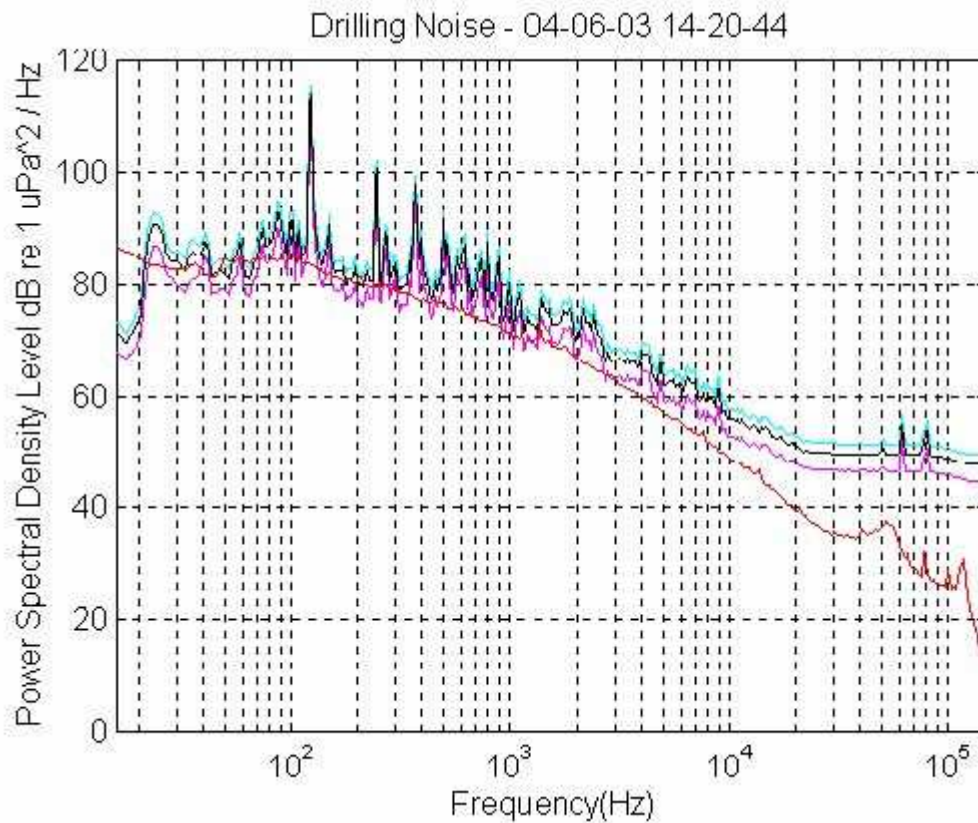

Figure 38. The power spectral density of the rock socket drilling noise from North Hoyle shown in Figure 37. The brown line indicates the mean background noise level.

Figure 39 shows power spectral density plotted against range from the source. The plot was created using 78 measurements of drilling noise. The plot shows the strong fundamental component at 125 Hz, and harmonics up to 1 kHz, as seen in Figure 38. The level of these components can be seen to fall away as range from the source increases. The horizontal red patches represent other dominant noise sources present at the time of measurement, mainly shipping traffic, which exhibits a broadband noise signature centred around 100 Hz. It is interesting to note that components of the drilling can be identified at ranges of up to 7 km.

Figure 40 shows the dB_{ht} level of the noise as a function of range. Unfortunately, as may be seen, the variation in levels recorded during drilling were such that it is difficult to establish Source Levels and Transmission Losses from the data. However, it may be seen from the figure that all of the levels, at ranges measured of 100 metres to 9 km or so, are below the level of 90 dB_{ht} at which a significant behavioural effect might occur. It may therefore be concluded that there is little likelihood of the noise from the drilling causing an environmental effect.

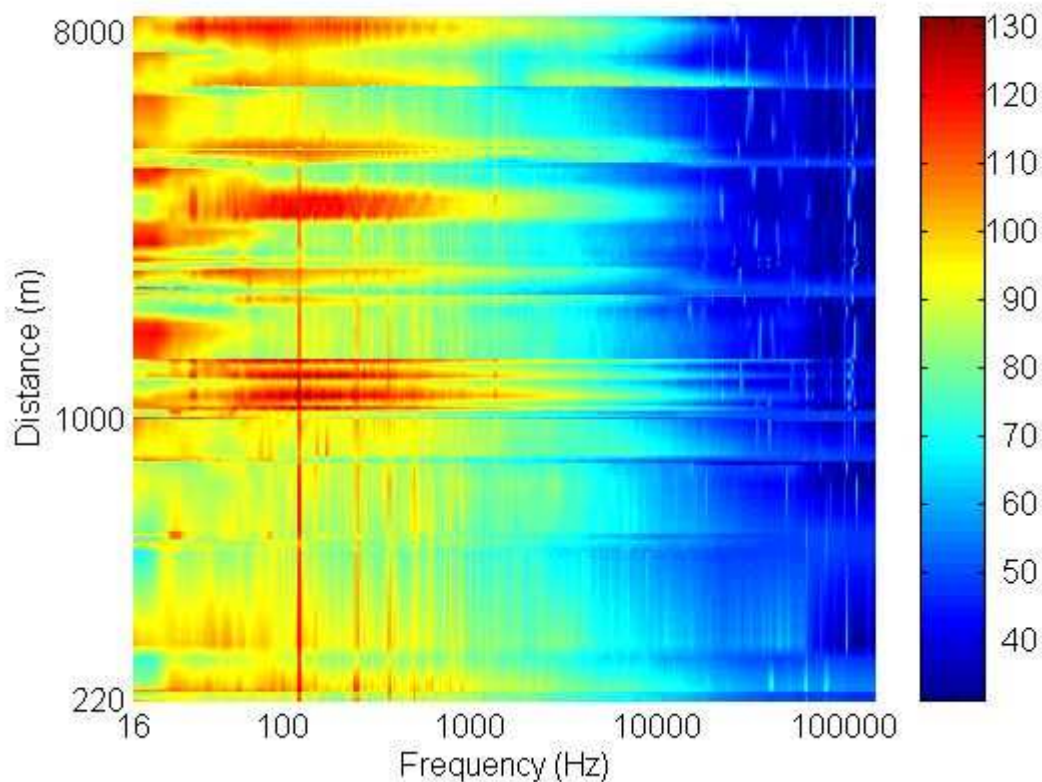

Figure 39. The power spectral density of rock socket drilling noise measurements from North Hoyle vs range from the source.

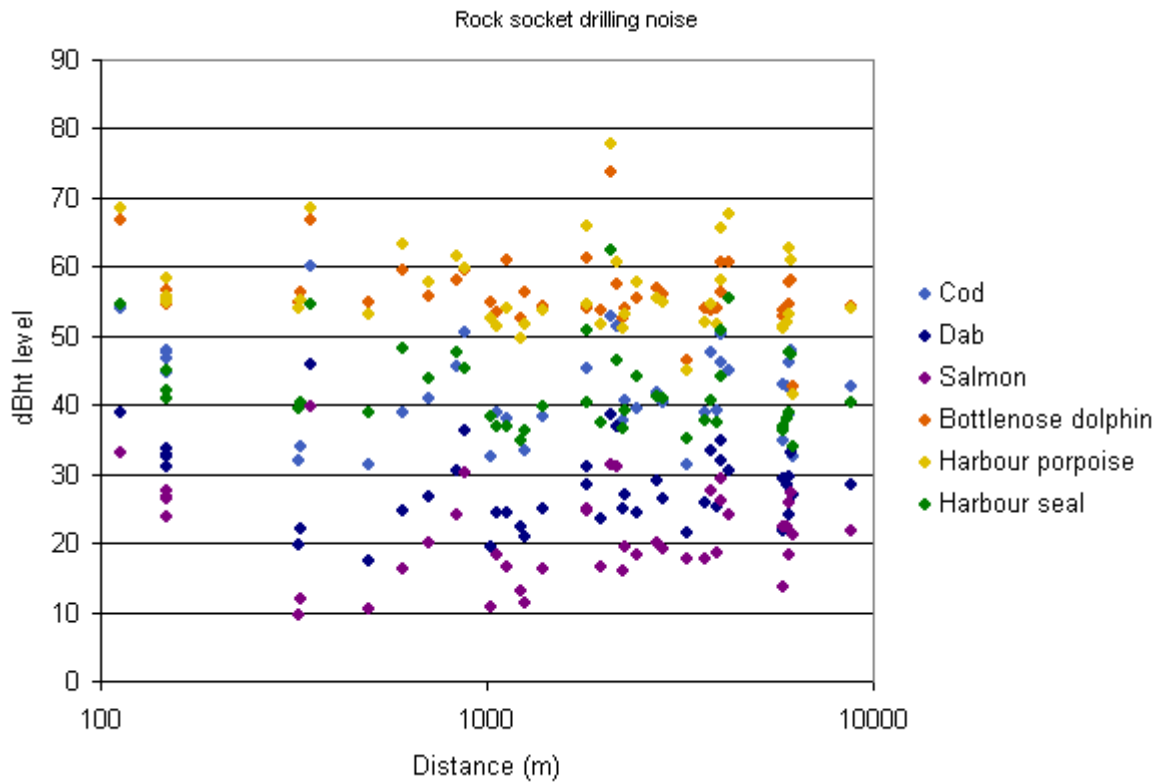

Figure 40. dB_{ht} values for six species as a function of range, for rock socket drilling at North Hoyle.

In summary:

1. the measurements of rock socket drilling noise indicate that while tonal noise could be detected at ranges of up to 7 km, it is a relatively low level noise source and there is little likelihood of the noise from the drilling causing an environmental effect.

7 Mitigation measures for piling.

This section primarily addresses mitigation of noise from piling, although many of the strategies identified here will also be useful for other sources of noise.

7.1 How piling creates noise

A brief description of the method by which noise from a pile being impact driven radiates into water is appropriate to understand how physical mitigation measures might work.

First, it should be noted that the mechanics of noise generation and propagation during piling are not well understood. However, many of the features of noise propagation from piling are similar to blast wave generation and propagation during underwater blasting, and it is possible to identify common features in time histories of the underwater pressure from both.

Noise is created in the air by the hammer, partly as a direct result of the impact of the hammer with the pile. Some of this airborne noise is transmitted into the water. However, of more significance in underwater noise is the radiation of noise from the surface of the pile as a consequence of the compressional, flexural or other complex structural waves that travel down the pile following the impact of the hammer on its head.

Figure 41 illustrates the paths by which the noise propagating from a pile may travel to a distant underwater point when it is struck by a pile driving hammer. The routes comprise:

1. **the airborne path.** Airborne noise caused by the impact and the radiating structural waves propagates through the air, and eventually passes down into the water. While this path exists, it is very inefficient at transferring noise to the water, for three reasons. First, there is a great difference in densities of air and steel and hence the transfer of energy between pile and air is inefficient. Second, due to diffraction, sound is only transferred efficiently into water from overhead airborne sources. Third, much of the energy of the sound is in any case reflected back from the air/water interface. Consequently, the airborne path is not likely to be a significant contributor to underwater noise;
2. **the waterborne path.** In this path, the waves travelling down through the pile encounter the water. Water is of similar density to steel and, in addition, due to its high sound speed (1500 m/sec as opposed to 340 m/sec for air), waves in the submerged section of the pile may efficiently couple into waves travelling in the water. These waterborne waves will radiate outwards, usually providing the greatest contribution to underwater noise;
3. **the groundborne path.** At the end of the pile force is exerted on the substrate not only by the mean force transmitted from the hammer by the pile but also by the structural waves travelling down the pile inducing lateral waves in the seabed. These may travel as both compressional waves, in a similar manner to the sound in the water, or as a seismic wave, where the displacement travels as Rayleigh waves. The waves can travel outwards through the seabed, or by reflection from deeper sediments, and as they propagate sound will tend to “leak” upwards into the water, contributing to the waterborne wave. Since the speed of sound is generally greater in consolidated sediments than in water, these waves usually arrive first as a precursor to the waterborne wave.

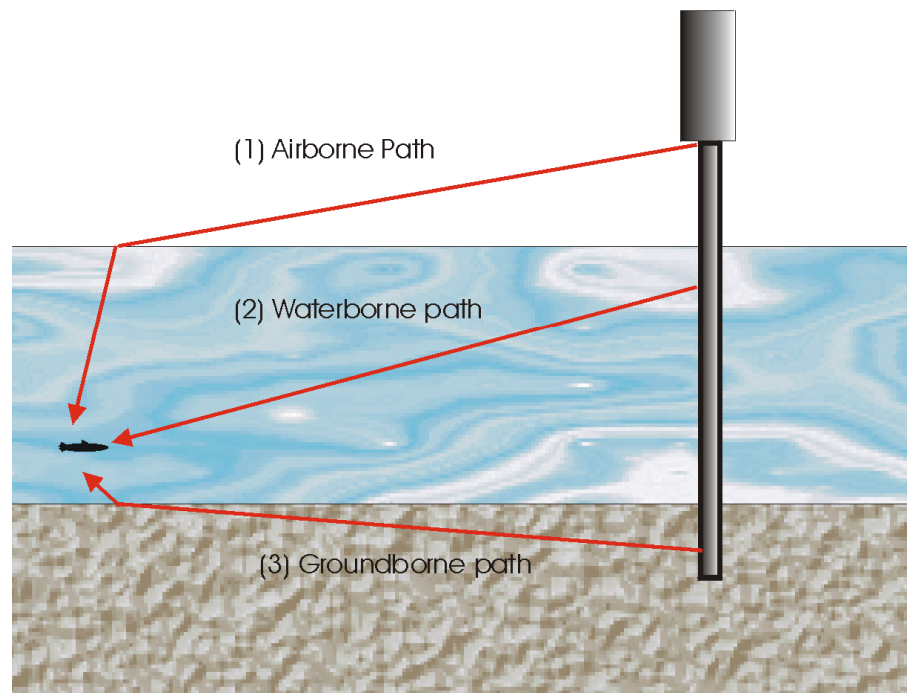

Figure 41. A sketch to illustrate the three paths by which sound can arrive from impact piling at a distant point in the water.

7.2 Quantification of likely effects.

The levels of sound presented in this report recorded during piling are such that they could cause behavioural effects (avoidance behaviour) of both marine mammals and fish at a distance of several kilometres from the piling. As indicated in section 6.1.3, the results also indicate that in the immediate vicinity of piling, say within 77 m or so, the underwater noise could cause physical injury.

This cannot be quantified and ranked in importance as an environmental effect without knowledge of:

1. the species that might be present,
2. their sensitivity to the noise for a particular effect and hence the area around the piling that might be affected;
3. the population density, such that the number of individuals that might be in this affected area can be calculated, and
4. the significance of the effect, or the risk of that effect, on those individuals or their stock.

All of these parameters are of significance in quantifying the degree of effect. This indicates why, in the initial stages of planning a piling operation, it should be regarded as capable of causing significant environmental effect, and planning of piling operations should take account of the above factors in assessing the potential effects of noise on sensitive species.

If the environmental consequences of the piling operation are deemed unacceptable, then use must be made of suitable mitigation measures to reduce the impact to an acceptable level. Examples where the effects of noise might be unacceptable include

1. where species are displaced away from a significant proportion of their feeding grounds;

2. where the species are endangered species, such that any effect is of unacceptable risk;
3. where an affected species is an important foodstock for an endangered species, and the effect of the noise may be to make the foodstock less available to the endangered species;
4. where the noise is in confined waters, on a migratory route, and is of sufficient duration that a significant proportion of a migratory period would be blocked;
5. where the noise has an economic impact, as for instance if whales were displaced from a whale watching area, or fish are displaced away from fishing grounds.

In many cases the noise may cause an effect which is of no environmental significance. For instance, a behavioural effect in which fish or mammals are simply displaced from the area of the piling to another area of similar habitat for a limited period may well be unimportant.

7.3 Mitigation measures

The aim of mitigation is to control and minimise the environmental impact of a piling operation, and comprises control of noise at source, mitigation by use of engineering and other methods, and monitoring of the results.

7.3.1 Control at source

Options that can be considered to minimise the noise from piling at source include:

1. **good engineering.** Providing attenuation of the piling noise by appropriate engineering is of prime importance, and using the correct specification of piles and pile driver for the job is of key importance when determining noise levels. This will help avoid situations where excessive energy might have to be used to achieve pile penetration;
2. **pile diameter.** It has been found by the authors that the noise level is closely related to the pile diameter; recorded noise levels during the driving of smaller piles have been found to be lower than for larger piles. It might therefore be possible, for instance, to reduce noise levels by using two or three small piles to replace one large monopile. However, it should be noted that the effect of pile diameter on noise is not yet fully understood, and the environmental benefit of the lower noise levels may be offset by the increased time taken to drive several smaller piles;
3. **bubble curtains.** Bubble curtains, or ascending curtains of bubbles from bubble pipes on the seabed, have been used to attenuate both blast and piling noise, but where their efficiency in terms of reducing environmental effects has been evaluated they typically only offer small improvements. It is not known, however, whether this results from an inherent deficiency, or whether it is because they have not been deployed in the most effective manner. It should also be noted that they would reduce only the waterborne wave, which may in some circumstances reduce their effectiveness;
4. **vibropiling.** Vibratory pile drivers are machines that drive piles into the ground by applying a rapidly alternating force to the pile, created by rapidly rotating eccentric weights. They are usually quieter than impact piling, but are not be capable of fully driving a pile into hard seabeds.

In general, while all of these methods have the potential to significantly reduce any effects of noise from piling, none have been investigated in a systematic manner and evaluated using a rigorous methodology.

7.3.2 Non-engineering methods

Primary and secondary effects. While the primary and secondary effects of impulsive noise may be severe, the range at which they occur is limited and hence the likelihood of an

unlucky marine mammal straying into the area prior to the commencement of piling is relatively low. Since the range of the effect is small, there are several mitigation measures that might be effective in preventing injury. These include:

1. **Marine Mammal Observers (MMOs).** MMOs are trained observers who may be able to visually detect and identify marine mammals, at distances of up to 500 m during daylight hours. Their use is mandatory during offshore seismic surveys. It may be possible to watch for species prior to commencing piling or to cease piling if target species enter the area during piling. However, many species are difficult to observe; in addition the approach does not work in poor visibility or at night.
2. **Passive Acoustic Monitoring (PAM) or Active Acoustic Monitoring (AAM).** Both passive and active sonar may be used to detect marine mammals. Passive acoustic monitoring, which detects underwater noise sources and their range, is only effective where vocalising species are likely to be present. Active acoustic monitoring, which illuminates an area with sound and detects returning noise scattered from targets, is relatively undeveloped but offers significant advantages, not only in being able to additionally detect the wide range of non-vocalising marine mammal species, but also other marine animals such as shoals of fish;
3. **Acoustic Harassment Devices (AHD).** AHDs are devices that generate high levels of underwater noise, such that a given species moves out of the area. They may be used prior to piling to ensure that animals have been moved out of the immediate area. These include seal scramblers, which may be effective against a range of marine mammals, and fish guidance systems, which may be similarly used to remove fish shoals from an area. Both of these work effectively at short ranges, and hence are probably most effective at reducing the possibility of fish kill or marine mammal injury near the piling. It should be noted that since they induce a deliberate disturbance, they may require licensing.

Other control methods include:

1. **scheduling.** Work may be scheduled for periods when the species are not in the area, for instance by avoiding migratory periods or periods where local breeding grounds are used. It should be noted, however, that this information is sometimes incomplete or difficult to obtain;
2. **soft start.** In this approach the behavioural effects of the noise are used to prevent injury. Piling commences at low energy levels, building up slowly to full impact force, in principle reducing the risk of injury to species by giving them time to flee the area.

7.3.3 Monitoring

Monitoring is an important component in mitigation, in that it enables control to be kept over noise levels. Where necessary, the actual levels of noise created can be demonstrated to interested parties. It also enables the noise created by a piling operation to be ranked against other local sources of noise. The monitoring can include:

1. **noise monitoring.** Fixed distance noise monitoring, as described in section 3.7.1, may be used to keep a record of noise levels and to provide an appropriate reaction if these are excessive. Ideally, monitoring should include “real time” feedback of the levels to contractors. Monitoring should be associated with two threshold levels, or “Action Levels”, each of which triggers an appropriate response. If the lower or First Action Level is exceeded, attention is drawn to the level of noise, with a requirement to consider whether the noise level can be reduced and hence whether any further action is required, but without a requirement to stop work. If the Second Action Level is exceeded, the piling contractor is required to stop work, find the cause of the excessive noise level and remedy it prior to work recommencing. The Action Levels specified will take account of

the effects of the noise on the species and will typically specify both a level and a position at which the noise should be monitored. For instance, for primary and secondary effects, if it is believed that marine mammals could be detected within 200 m of the piling it might be appropriate to specify as the Second Action Level the level of impulse at which injury could occur (163 dB re 1 μ Pa.s, from the results of Yelverton (1972)) at the distance where the mammal could be detected (200 m). The level of impulse at which no effects are expected (151 dB re 1 μ Pa.s) might be specified as the First Action Level. In respect of tertiary or behavioural effects, consider for instance piling located in the centre of a channel that is a migratory route, in a period where there might be migration. It might be deemed acceptable, for instance, to block not more than 20% of the width of the channel. In this case a Second Action Level at which significant avoidance occurs, 90 dB_{ht}, might be specified, measured at points plus and minus 10% of the channel width on either side of the piling. In the case where specific areas are being protected, such as feeding or haul-out areas, the noise level may be measured at these points;

2. **caged fish trials.** Caged fish trials may be used to monitor or confirm the reaction, or lack of it, of locally important fish to the noise. Typically such a trial will involve a small number of individuals of the species of concern. The monitoring may involve watching for instinctive reactions, such as sea-starts, or assessing whether there is a cognitive effect, such as the fish tending to move to the side of the cage furthest from the noise.
3. **marine mammal observation.** The monitoring of local mammals may also confirm whether there is any effect of the noise. One method of monitoring is to observe local haul-out areas, although it is difficult to ensure that the monitoring itself is not causing an effect. Other methods are to monitor the distribution of individuals around the noise source by tagging, by using passive acoustic monitoring to detect vocalisation, or by using active acoustic monitoring.

The latter two monitoring strategies (for fish and marine mammals respectively) may serve two purposes, either of demonstrating that there is no effect, or, if an effect is observed, of identifying the level at which it occurs. While it may be argued that the monitoring itself has an effect on the species, this effect may be outweighed by the process providing information which may be used in the longer term to preserve stocks of the species and to minimise the effects of future offshore construction projects.

8 Summary and conclusions.

A good quality set of measurements has been made of underwater ambient noise in typical windfarm areas, and on an opportunity basis of typical sources of noise during construction.

1. The measurements of ambient noise in shoals indicates that, in general, the levels are towards the upper bound of the deep water ambient noise levels presented by Wenz. The overall sound pressure level varies significantly more during the daytime than at night, due to the higher number of short local ship movements.
2. Estimates of the dB_{ht} levels (perceived levels) of the background noise at North Hoyle indicate that typical marine mammals perceive a higher level of ambient noise, associated with low variability, than typical fish species, which perceive greater variability. The porpoise perceives the highest level, of 53 dB_{ht} (*Phocoena phocoena*). This would compare to, for instance, the level of background noise that humans would perceive in a noisy office environment.
3. Measurements of piling noise at North Hoyle indicated a Source Level of 260 dB re 1 μPa @ 1 m for 5 m depth, and 262 dB re 1 μPa @ 1 m at 10 m depth, associated with a Transmission Loss given by $22 \log(R)$, where R is the range. Calculations of dB_{ht} levels indicate that strong avoidance reaction by a range of species would be likely at ranges of up to several kilometres. The levels of sound recorded during piling are such that within perhaps 100 m they could cause injury.
4. Measurements of piling noise at Scroby Sands were similar in level to those at North Hoyle, and similar conclusions can be drawn in respect of possible environmental effects.
5. Measurements of cable trenching at North Hoyle indicate a Source Level of 178 dB re 1 μPa @ 1 m if a Transmission Loss of $22 \log(R)$ is assumed.
6. Measurements of rock socket drilling were made, which showed strong fundamental component at 125 Hz, and harmonics up to 1 kHz, but it was not possible to establish the Source Level and Transmission Loss. Components of the drilling could, however, be identified at ranges of up to 7 km.
7. On the basis of the measurements, piling in particular should be regarded as capable of causing significant environmental effects, and planning of piling operations should take account of the effects of its noise on sensitive species.
8. Mitigation measures are discussed, which include the use of best engineering practices, bubble curtains, Marine Mammal Observers, passive and active acoustic monitoring, scheduling to avoid sensitive times, soft starts, monitoring of noise levels, and caged fish and tagged marine mammal monitoring.

9 References

- Abbott, R. (2001). *San Francisco – Oakland Bay Bridge East Span Seismic Safety Project, Pile Installation Demonstration Project, Fisheries Impact Assessment*. Report PIDP EA 012081 on CalTrans Contract 04A014 8.
- Christian, E. A.(1973). *The effects of underwater explosions on swimbladder fish*. Naval Ordnance Laboratory, White Oak, Silver Spring MD. NOLTR 73-103, 33 pp.
- Hill, S.H. (1978). *A guide to the effects of underwater shock waves in arctic marine mammals and fish*. Pacific Mar. Sci. Rep.78-26. Inst. Ocean Sciences, Patricia Bay, Sidney, B.C. 50 pp.
- Knudsen V. O. Alford R. S. and Emling J. W. (1948). *Underwater ambient noise*. Journal of Marine Research, V10, pp 410.
- Nedwell, J R and Turnpenny A W H. (1998a). *The use of a generic weighted frequency scale in estimating environmental effect*. Proceedings of the Workshop on Seismics and Marine Mammals, 23rd-25th June 1998, London. UK.
- Nedwell, J R, Turnpenny, A W H , and Lambert, D (1998b). *Guiding fish with sound, the acoustics of fish behavioural barrier design*. 128th Annual Meeting of the American Fisheries Society Conference, Baltimore, USA August 1998.
- Nedwell J. R., Needham K., Turnpenny A. W. H. and Thompson D (1999). *Measurement of sound during a 3D seismic survey in blocks 14/14a of the North Sea*. Subacoustech report to Texaco plc, reference 356R0108, 26 February 1999. Subacoustech Ltd, Chase Mill, Winchester Road, Bishop's Waltham, Hampshire SO32 1AH, United Kingdom.
- Nedwell, J.R, Turnpenny, A.W.H, Lovell, J, Langworthy, J, Howell, D. & Edwards, B. (2003) *The effects of underwater noise from coastal piling on salmon (Salmo salar) and brown trout (Salmo trutta)*. Subacoustech report to the Environment Agency, reference 576R0113. Dec. 2003. Subacoustech Ltd, Chase Mill, Winchester Road, Bishop's Waltham, Hampshire SO32 1AH, United Kingdom.
- Nedwell, J.R and Howell, D. M. (2004a) *A review of offshore windfarm related noise sources*. Subacoustech report to COWRIE, reference 544R0310. May 2004. Subacoustech Ltd, Chase Mill, Winchester Road, Bishop's Waltham, Hampshire SO32 1AH, United Kingdom.
- Nedwell J.R. , Edwards B. , Turnpenny A.W.H. and Gordon J. (2004b) *Fish and Marine Mammal Audiograms: A summary of available information*. Subacoustech report to Joint Industry Group, reference 534R0213. May 2004. Subacoustech Ltd, Chase Mill, Winchester Road, Bishop's Waltham, Hampshire SO32 1AH, United Kingdom.
- Richardson, W.J., Greene, C.R., Malme, C.I. & Thomson, D.H. (1995). *Marine Mammals and Noise*. Academic Press, London.
- Tougaard, J., Carstensen, J., Henriksen, O.D., Skov, H. & Teilmann, J. (2003). *Short-term effects of the construction of wind turbines on harbour porpoises at Horns Reef*. Technical report to TechWise A/S. HME/362-02662, Hedeselskabet, Roskilde.
- Turnpenny, A.W.H. & Nedwell, J.R. (1994). *The effects on marine fish, diving mammals and birds of underwater sound generated by seismic surveys*. Report to the UK Offshore Operators Association, No FRR 089/94.
- Wenz, G. (1962). *Acoustic ambient noise in the ocean; spectra and sources*. Journal of the Acoustical Society of America, N34, pp 1936.
- Yelverton, J.T., Richmond, D.R., Hicks, W., Sanders, K. & Fletcher, E.R. (1972). *Safe distances from underwater explosions for mammals and birds*. DNA 3114T, Rep. from Lovelace Foundation for Medical Educ. and Res., Albuquerque, NM, for Defense Nuclear Agency, Washington, DC. 67 pp. NTIS AD-766952.

10 Appendix A - Measuring noise

Units for measuring noise

The fundamental unit of sound pressure is the Newton per square metre, or Pascal.

Impulsive noise sources

Impulsive noise sources are considered to be those having finite duration, such as piling and underwater blast, and can be characterised by two key parameters, viz. peak pressure and impulse.

Peak pressure

The peak pressure of an impulsive source, P_{\max} , is the maximum pressure in the sound wave generated by the source. It is usually the initial peak of the waveform and is easily read from a recording of the time history. The peak pressure of an impulsive source is the parameter normally used as the measure of its strength with regard to causing physical injury to animals.

Impulse

The impulse, I , is defined as the integral of pressure over time and is given by

$$I = \int_0^{\infty} P(t) dt ,$$

where I is the impulse in Pascal-seconds (Pa.s), $P(t)$ is the acoustic pressure in Pa of the sound wave at time t , and t is time. Impulse may be thought of as the average pressure of the wave multiplied by its duration. The importance of impulse is that in many cases a wave acting for a given time will have the same effect as one of twice the pressure acting for half the time. The impulse of both these waves would be the same. The impulse is the parameter of an impulsive source normally used as the measure of its strength with regard to environmental effects.

Non-impulsive noise sources

Non-impulsive noise sources may be categorised as having largely constant variation in amplitude with time; examples would include noise from a propeller or engine. Non-impulsive sounds are usually quantified using the root mean square (RMS) pressure level.

RMS pressure

The RMS pressure is defined by

$$P_{RMS} = \sqrt{\frac{1}{T} \int_0^T P^2(t) . dt}$$

where the period T must be large compared with the period of the lowest frequency component in the signal. In this report the time averaging period used has been 1 second.

Sound pressure level

In quantifying underwater acoustic phenomena it is convenient to express the sound pressure (either peak or RMS as described above) through the use of a logarithmic scale termed the *Sound Pressure Level*.

There are two reasons for this:

1. There is a very wide range of sound pressures measured underwater, from around 0.0000001 Pascal in quiet sea to say 10000000 Pascal for an explosive blast. The use

of a logarithmic scale compresses the range so that it can be easily described (in this example, from 0 dB to 260 dB re 1 μ Pa).

2. Many of the mechanisms affecting sound underwater cause loss of sound at a constant rate when it is expressed on the dB scale.

The Sound Pressure Level, or SPL, is defined as

$$SPL = 20 \log \left(\frac{P}{P_{ref}} \right)$$

where P is the sound pressure to be expressed on the scale and P_{ref} is the reference pressure, which for underwater applications is 1 μ Pa.

All sound levels presented in this report are expressed in decibels referenced to 1 microPascal, i.e. as dB re 1 μ Pa.

Source Level and Transmission Loss.

In order to provide an objective and quantitative assessment of the degree of any environmental effect it is necessary to estimate the sound level as a function of distance. To make this estimation and, hence, to estimate the range within which there may be an effect of the sound, it is necessary to know the level of sound generated by the source and the rate at which it decays as it propagates away from the source. The two parameters used are:

1. the Source Level (i.e. level of sound) generated by the source, and
2. the Transmission Loss, i.e. the rate at which sound is attenuated as it propagates away from the source.

These two parameters allow the sound level at all points in the water to be specified, and in the current state of knowledge are best measured at in the field, although it is in principle possible to estimate the transmission loss using numerical models. Usually this data has to be extrapolated to situations other than those in which the noise was measured; the usual method of modelling the level is from the expression

$$SPL = SL - N \log R - \alpha R$$

where R is the distance from the source in metres, and N and α are coefficients relating respectively to geometric spreading of the sound and absorption of the sound. If the level of sound at which a given effect of the sound is known, an estimate may be made of the range within which there will be an effect.

Source Level

The Source Level of a source is defined as the "effective" level of sound at a nominal distance of 1 metre, expressed in dB re 1 μ Pa. However, the assumptions behind this simple definition warrant careful explanation.

When taking sound measurements it is normal to measure the sound pressure in the far field, i.e. at sufficient distance from the transducer that the field has "settled down", and to extrapolate these pressures to estimate the *apparent* (or *effective*) level at a nominal 1 metre from the source. The apparent level may bear no relation to the actual level.

A measurement of the apparent level can be accomplished by assuming inverse dependence of pressure on the range from the noise source, or by extrapolating the far field pressure back towards the source. For instance, if measurements were made in the range 100 m to 10000 m in the example in the diagram (Figure A.1), the apparent level would, as illustrated by the extrapolation, be much higher than the actual level.

There is in general no reliable way of *predicting* the noise level from sources of man-made noise, and hence it is normal to directly measure the source level where a requirement exists to estimate far-field levels.

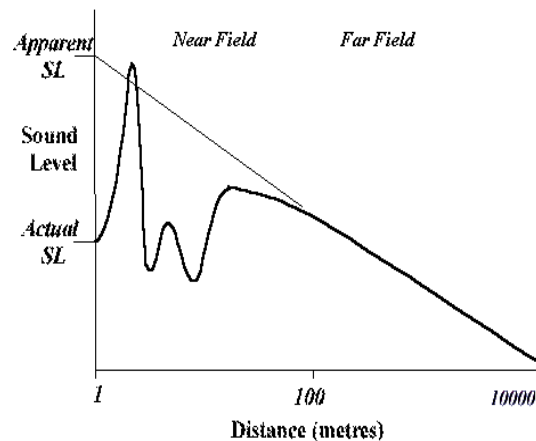

Figure A.1. Source level and near field effects.

Transmission Loss

Transmission in the ocean has probably been the subject of more interest than any other topic in underwater communication, since it is the parameter that is the least predictable and the least capable of being influenced.

The sound from a source can travel through the water both directly and by means of multiple bounces between the surface and seabed. Sound may also travel sideways through the rocks of the seabed, re-emerging back into the water at a distance. Refraction and absorption further distort the waveform, leading to a complex wave arriving at a distant point which may bear little resemblance to the wave in the vicinity of the source. Finally, sound may be carried with little loss to great distances by being trapped in sound channels.

Predicting the level of sound from a source is therefore extremely difficult, and use is generally made of simple models or empirical data for its estimation.

Estimates of Transmission Loss

Transmission loss, or TL, is a measure of the rate at which sound energy is lost, and is defined as

$$TL = 20 \log \left(\frac{P_0}{P_R} \right)$$

where P_0 is the pressure at a point at 1 metre from the source, and P_R is the pressure at range R away from it.

The usual method of modelling the transmission loss is from the expression

$$TL = N \log R - \alpha R$$

where R is the range from the source in metres and N and α are coefficients relating respectively to geometric spreading of the sound and absorption of the sound. High values of N and α relate to rapid attenuation of the sound and limited area of environmental effect, and low values to the converse. For ranges of less than 10 km the linear attenuation term α can in general be ignored; a value of N of 20, corresponding to spherical spreading of the sound according to the inverse square law, is often assumed.

The dB_{ht} (*species*) scale for perceived noise levels

We use the term “perception scale” to describe a scale for measuring sound which incorporates the sensitivity of the species as a function of frequency to the sound, and hence allows its “loudness” for that species to be judged.

The dB(A), or human perception scale

The dB(A) is well established as a means by which the behavioural effects of sound on a human may be judged. We propose the extension of the principle on which it is related to marine mammals and fish.

Implementation of the dB(A)

The human ear is most sensitive to sound at frequencies of the order of 1 to 4 kHz, and hence these frequencies are of greatest importance in determining the physical and psychological effects of sound for humans. At lower or higher frequencies the ear is much less sensitive, and humans are hence more tolerant of sound at these frequencies. To reflect the importance of this effect a scale of sound (the dB(A)) has been developed which allows for the frequency response of the human ear. In order to estimate the physical and subjective effects of sound using this scale, the sound signal is first weighted by being passed through a filter which approximately mimics the effectiveness of human hearing. The sound is measured after undergoing this process. The level of sound that results is well established as being related to its effects on humans. The dB(A) also enables simple judgement of the effect of sound on humans to be made e.g. "sound at 120 dB(A) is unbearably loud". This can be interpreted as "sound at one million times the human threshold of hearing is unbearably loud".

The dB_{ht} (*species*)

Concerns over the environmental effects of offshore seismic shooting using airguns prompted the authors in 1995 to propose a formal perception scale for application to a wide range of species. The dB_{ht}(*species*) level is the scale which has been developed. It is estimated by passing the sound through a filter that mimics the hearing ability of the species, and measuring the level of sound after the filter; the level expressed on this scale is different for each species (which is the reason that the specific name is appended) and corresponds to the perception of the sound by that species. A set of coefficients is used to define the behaviour of the filter so that it corresponds to the way that the acuity of hearing of the candidate species varies with frequency: the sound level after the filter corresponds to the perception of the sound by the species. The scale may be thought of as a dB scale where the species’ hearing threshold is used as the reference unit; typical thresholds are shown below. A single number (the dB_{ht}(*species*)) therefore describes the effects of the sound on that species.

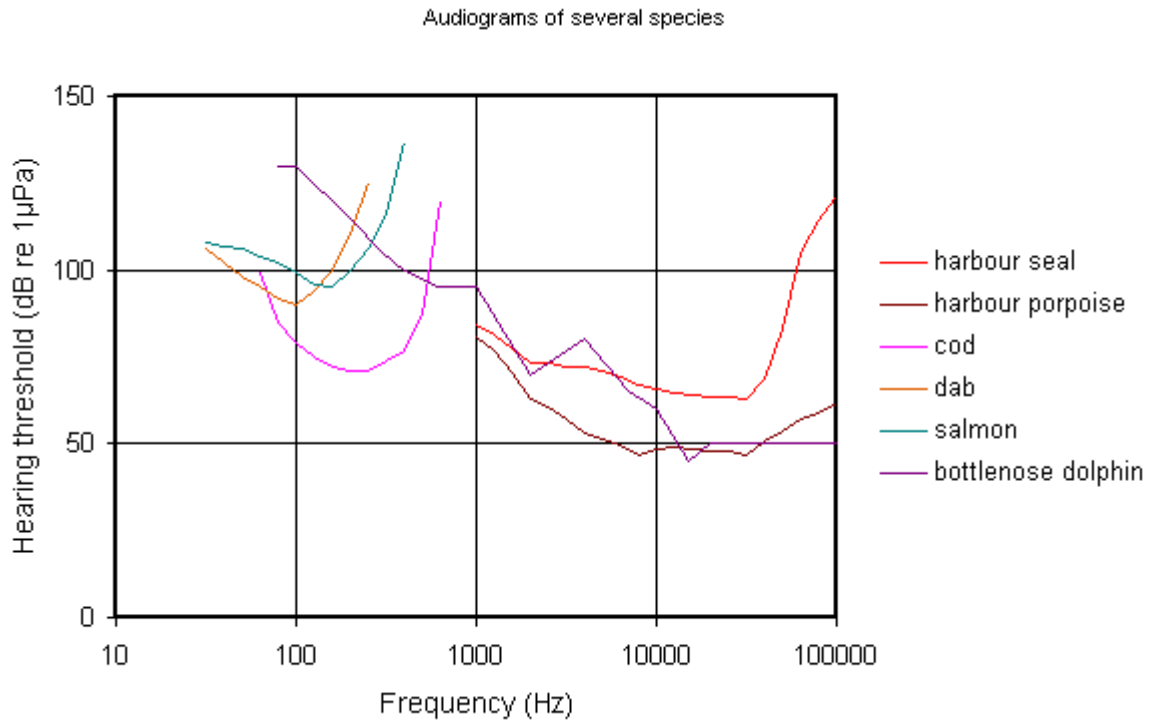

Figure A2. Typical audiograms

11 Appendix B - Details of instrumentation and measurement techniques

Hydrophone measurement system

Figure B.1 presents a diagram of the Subacoustech underwater noise measurement system. On the left two hydrophones are shown, a B&K 8106 hydrophone and a B&K 8105 hydrophone. Depending on the characteristics of the noise source, measurements will be taken with either or both of these hydrophones.

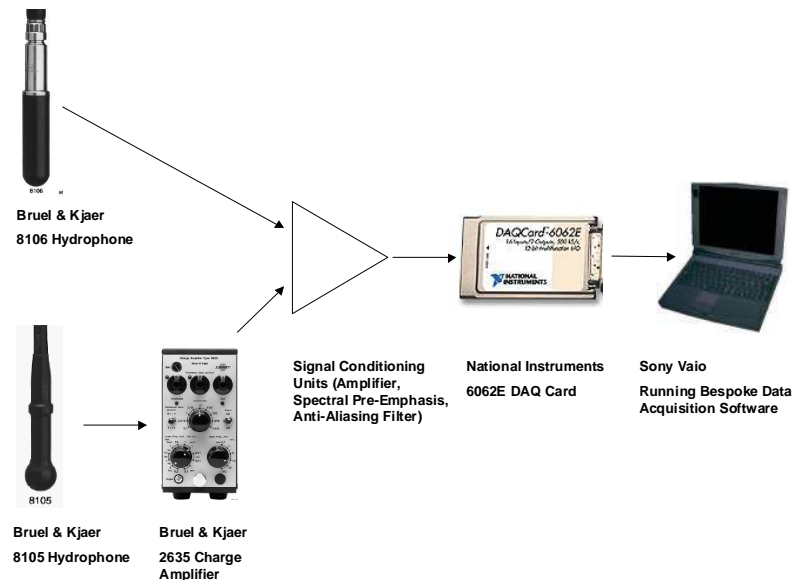

Figure B.1. Measurement system diagram.

The hydrophones exhibit the following electro-acoustic properties:

8105 Hydrophone:

- receiving sensitivity of -205 dB re 1 V/ μ Pa.
- suitable for measurements within the frequency range 0.1 Hz to 160 kHz.

8106 Hydrophone:

- receiving sensitivity of -174 dB re 1 V/ μ Pa.
- suitable for measurements within the frequency range 7 Hz to 80 kHz.
- equivalent noise level well below Sea State zero.

The 8105 hydrophone is connected to a B&K Type 2635 charge amplifier which has variable gain and includes a 2 Hz high pass filter. The 8106 hydrophone includes a 10 dB pre-amplifier, which is powered by a Subacoustech Type 68E0101 power supply.

Before digitisation, the hydrophone signals are conditioned using a selection of signal conditioning units. The signal conditioning includes a switchable spectral pre-emphasis stage, a switchable amplifier stage, and an anti-aliasing filter stage.

Underwater noise is typically several orders of magnitude greater at low frequencies than at high frequencies. To make full use of the DAQ card's dynamic range, the signal can be pre-emphasised, so that upon digitisation the incoming signal is at a similar level across all frequencies. Similarly, the signal is amplified to match the signal's level to the DAQ card's input range. Finally, unwanted high frequency components are removed using an anti-aliasing filter.

The conditioned hydrophone signal is digitised using a National Instruments 6062E DAQ card installed in a Sony Vaio PCG-FX101 laptop computer. The card has the following specification:

- 12 bit resolution, which equates to a dynamic range of 72.2 dB;
- variable sample rate of up to 500 kHz. However measurements will typically be made using a sample rate of 300 kHz and above to give a bandwidth of at least 150 kHz

Electrical grounding of the equipment is achieved using a brass plate, either in the hull or immersed in the sea over the side of the vessel. In addition, all measurement systems are battery powered, removing contamination of the signal by electrical and mechanical noise from a generator. During measurements, all electrical and mechanical systems on board the vessel are shut down to minimise vessel noise (unless safety considerations require either the VHF radio or radar).

To further minimise vessel noise contamination, the hydrophones are deployed approximately 10 m from the boat. The hydrophones are suspended at suitable depths from an anti-heave buoy, and are fastened to the vessel via an anti-shock cable mount.

Sound speed profile measurement

Underwater noise measurements, in conjunction with relevant sound velocity profiles, allow computer modelling of underwater noise propagation. A conductivity, temperature and depth (CTD) probe provides the required parameters for the calculation of sound speed and can be lowered through the water column to provide a sound speed profile. Measurement are made using a Valeport 600 MK II CTD probe, in conjunction with a National Instruments 6062E DAQ card to measure conductivity and temperature as a function of depth, which may be used to evaluate sound velocity profiles.

Other measurements

The following records are also made for each underwater noise measurement:

1. GPS co-ordinates (accurate to 10 m)
2. time and date
3. wind speed and direction
4. sea state
5. local shipping movements
6. relevant video recordings
7. water depth

Quality assurance

The following quality assurance measures are undertaken:

1. all equipment is inspected and tested prior to use;
2. while at sea, measurements are inspected during recording using both audio and visual techniques, including spectral analysis, for common errors such as clipping and noise contamination;
3. before publication, measurements are scrutinised by at least two members of staff;
4. sample sound files are included with each report to allow independent verification of the measurement's quality; and
5. calibration certificates are included in each report for relevant equipment.

12 Appendix C - Description of windfarm-related noise sources

Sources of windfarm-related underwater noise

Below is a list of some of the potential sources of windfarm-related noise that have been identified and which may be measured as part of the COWRIE study:

- 1 geophysical survey,
- 2 pile installation,
- 3 cable trenching,
- 4 rock back-filling,
- 5 scour protection installation,
- 6 construction and support vessel machinery, and
- 7 operational wind turbines.

13 Appendix D - Calibration charts.

Calibration Chart for Hydrophone Type 8106 Serial No.:2256725

Calibration Chart for Hydrophone Type 8106

Serial No.: 2256725

Reference Sensitivity at 25 Hz* $\pm 2\%$ at 23 °C

Voltage Sensitivity (Open Circuit Sensitivity):
 -172.6 dB ± 0.25 dB re 1 V/ μ Pa** or 23.44 μ V/Pa

Frequency Response (at ref. pos.):
 Individual Free Field Frequency Response Curve attached

Measurement Uncertainty: (re 4 kHz)

4 to 80 kHz ± 1.5 dB
 80 to 100 kHz ± 1.8 dB
 100 to 125 kHz $+3.5$ dB, -1.5 dB

Summarized Specifications (re 250 Hz)

Frequency Response (tolerance field excluding measurement uncertainty):
 10 Hz to 10 kHz $+0.5$ dB, -3 dB
 7 Hz to 30 kHz $+0.5$ dB, -6 dB
 3 Hz to 80 kHz $+6$ dB, -10 dB

Horizontal Directivity 20 kHz:
 (radial XY-plane) ± 2 dB

Vertical Directivity 20 kHz:
 (radial XZ-plane) ± 3 dB

Note: All values are typical at 25° C (77° F), unless measurement uncertainty or tolerance limit is specified. All uncertainty values are specified at 2 σ (i.e. expanded uncertainty using a coverage factor of 2).

CE
 For further information, see Product Data Sheet BP 0317

Date 08-Feb-01 Signature [Signature]



Physical (mm)



Weight (excluding cable): 382 g

Preamplifier

Gain: 10 dB

Maximum Output Signal: 3.5 V or 28 mA for a 12 V supply; 7.0 or 28 mA for a 24 V supply

High-pass Filter: -3 dB at 7 Hz (± 2 Hz)

Maximum Output Effect: 50 mW

Output Impedance: $< 30 \Omega$

Caution:
 Do not exceed 12 V Insert-voltage calibration signal

Environmental

Operating Temperature Range: -10° C to $+60^\circ$ C

Storage Temperature Range: -40° C to $+80^\circ$ C

Change of Voltage Sensitivity with Temperature: 0 to 0.01 dB/°C

Change of Sensitivity with Static Pressure: 0 to -1×10^{-2} dB/Pa (0 to -0.01 dB/atm)

Maximum Operating Static Pressure: 9.8×10^6 Pa (100 atm)

Allowable Total Radiation Dose: 5×10^7 Rad

For further information see User Manual

* Sensitivity Traceable to:
 DPLA: Danish Primary Laboratory of Acoustics
 NIST: National Institute of Standards and Technology, USA

** 1 Pascal = $1 \text{ N/m}^2 = 10 \mu\text{bar}$

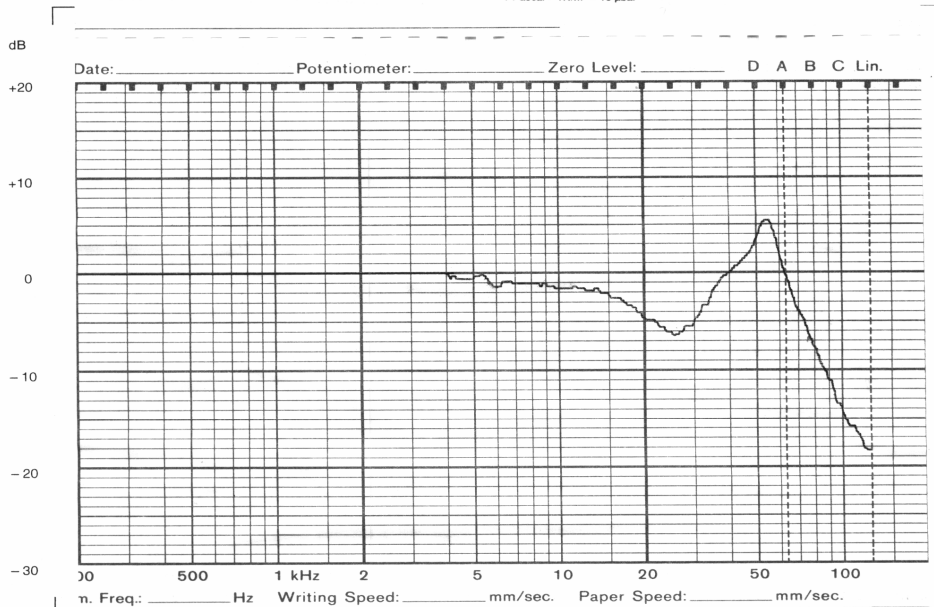



Calibration Chart for Hydrophone Type 8105

Serial No. *1461320*

Reference Sensitivity at *250* Hz* at *23* °C including 10m integral cable

Cable Capacitance 150 pF/m typical

Open Circuit Sensitivity:

Voltage Sensitivity: *2050* dB re 1 V/μPa** or *562* μV/Pa

Charge Sensitivity: *407* · 10⁻³ pC/Pa

Capacitance (including 10m cable) *2250* pF

Leakage Resistance: *>1 · 10⁻⁴* MΩ at *23* °C

Frequency Response: Individual Free Field Frequency Response Curve attached

Date *90-02-05* Signature *O.M.*

Summarized Specifications:

Usable Frequency Range: 0,1 Hz to 160 kHz ^{+2 dB} _{-10 dB}

Linear Frequency Range: 0,1 Hz to 100 kHz ^{+0,5 dB} _{-4 dB}

Horizontal Directivity 100 kHz: (XY-plane) typical ± 2 dB

Vertical Directivity 100 kHz (270°): (XZ-plane) typical ± 2 dB

Physical (mm):

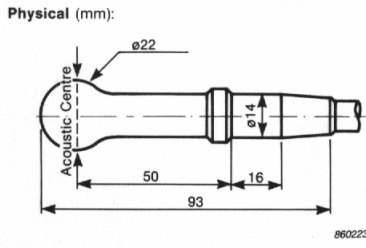

Operating Temperature Range:
Short term -40°C to +120°C
Continuous -40°C to + 80°C

Change of Sensitivity with Temperature:
Charge 0 to 0,03 dB/°C
Voltage 0 to -0,03 dB/°C

Change of Sensitivity with Static Pressure:
0 to -3 × 10⁻⁷ dB/Pa
(0 to -0,03 dB/atm)

Allowable Total Radiation Dose: 5 × 10⁷ Rad

Maximum Operating Static Pressure:
9,8 × 10⁶ Pa (100 atm)

Cable:
Two conductors shielded low noise
Waterblocked to MIL-C-915

Weight including 10 m cable: 1,6 kg

For further information see instruction manual

* Traceable to NBS
** 1 Pascal = 1 N/m² = 10 μbar

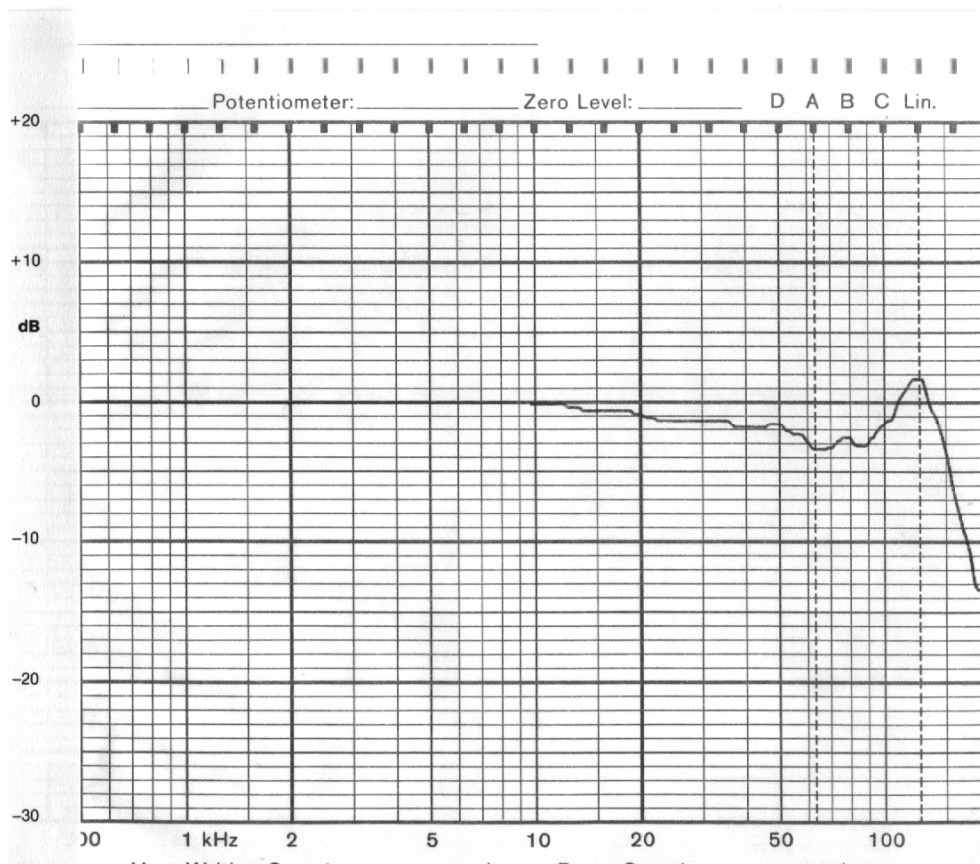



Certificate of Calibration

Board Information

Serial Number: C55869
NI Part Number: 186554E-01
Description: DAQCard-6062E

Certificate Information

Certificate Number: 222115
Date Printed: 05-FEB-2001
NI Part Number: 184632A-01

Calibration Date: 05-FEB-2001
Calibration Interval: 12 Months
Calibration Due: 05-FEB-2002

Ambient Temperature: 24 °C
Relative Humidity: 43 %

National Instruments certifies that at the time of manufacture, the above product was calibrated in accordance with applicable National Instruments procedures. These procedures are in compliance with relevant clauses of ISO 9002 and are designed to assure that the product listed above meets or exceeds National Instruments specifications.

National Instruments further certifies that the measurements standards and instruments used during the calibration of this product are traceable to the National Institute of Standards and Technology or are derived from accepted values of natural physical constants.

The environment in which this product was calibrated is maintained within the operating specifications of the instrument and the standards.

For questions or comments, please contact National Instruments Technical Support.

Signed,

Domingo Salcido
Operations Manager

09/08/00
321722C-01

National Instruments has been registered as compliant with the ISO 9002-1994 standard.



14 Appendix E - Record of changes

1. This is a controlled document.
2. Additional copies should be obtained through the Subacoustech Librarian.
3. If copied locally, each document must be marked "Uncontrolled Copy".
4. Amendment shall be by whole document replacement.
5. Proposals for change to this document should be forwarded to Subacoustech.

Issue	Date	Details of changes
544R0401	4/12/03	Drafted JRN
544R0402	10/12/04	Internal review BE
544R0403	11/12/04	Redraft JRN
544R0404	16/12/03	Internal review BE
544R0405	17/12/03	Redraft JRN
544R0406	19/12/03	Internal review BE, JL
544R0407	5/1/04	Redraft JRN
544R0408	19/1/04	Internal review BE
544R0409	19/1/04	Redraft JRN, JL
544R0410	27/1/04	Extra information plus drawings JRN, JL
544R0411	13/2/04	Text and drawings altered JRN
544R0412	16/2/04	Alteration of report order JRN
544R0413	16/2/04	Internal review BE
544R0414	18/2/04	Modifications JRN
544R0415	20/2/04	Review DL and redraft JRN
544R0416	20/2/04	Draft issued
544R0417	10/5/04	Revision
544R0418	17/5/04	Amendments JRN.
544R0419	20/5/04	Layout revision
544R0420	21/5/04	Layout revision
544R0421	26/5/04	Revision
544R0422	26/5/04	Revision.
544R0423	26/5/04	Draft issued
544R0424	18/8/04	Amended and report issued

1. Originator's current report number	544R04
2. Originator's Name & Location	J.R.N., Subacoustech
3. Contract number & period covered	544; 1 st April 2003 – 30 th January 2004
4. Sponsor's name & location	COWRIE for Crown Estates
5. Report Classification & Caveats in use	UNCLASSIFIED; UNLIMITED DISTRIBUTION.
6a. Date written	
6b. Pagination	
6c. References	
7a. Report Title	
7b. Translation / Conference details	
7c. Title classification	UNCLASSIFIED
8. Authors	
9. Descriptors / Key words	Underwater, noise, windfarm, piling, drilling.
10a Abstract	
10b. Abstract classification	UNCLASSIFIED; UNLIMITED DISTRIBUTION.