

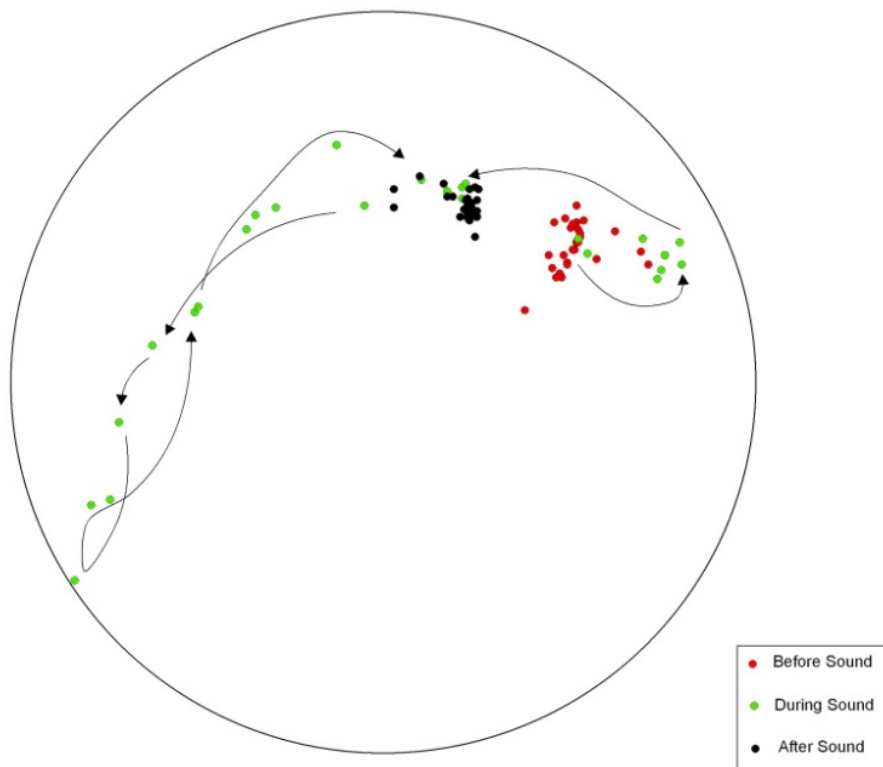

EFFECTS OF PILE-DRIVING NOISE ON THE BEHAVIOUR OF MARINE FISH



COWRIE Ref: Fish 06-08 / Cefas Ref: C3371
Technical Report 31th March 2010

Christina Mueller-Blenkle, Peter K. McGregor,
Andrew B. Gill, Mathias H. Andersson,
Julian Metcalfe, Victoria Bendall, Peter Sigray,
Daniel Wood, Frank Thomsen

Author affiliations

Project Leader and Corresponding Author
Dr Frank Thomsen
Team Leader and Scientific Programme Manager
Cefas Lowestoft Laboratory
Pakefield Road
Lowestoft
NR33 0HT
Tel: + 44 (0) 1502 524284
Email: frank.thomsen@cefas.co.uk

Christina Mueller-Blenkle, Julian Metcalfe,
Victoria Bendall, Daniel Wood
Cefas Lowestoft Laboratory
Pakefield Road
Lowestoft
NR33 0HT
UK

Peter K. McGregor
Cornwall College, Newquay
Wildflower Lane
Trenance Gardens
Newquay
Cornwall, TR7 2LZ
UK

Andrew B. Gill
Natural Resources Department
Bldg 37
School of Applied Sciences
Cranfield University
Cranfield
MK43 0AL
UK

Peter Sigray
Department of Meteorology
Stockholm University
S-106 91 Stockholm
Department of Underwater Research
Swedish Defence Agency (FOI)
S-164 90 Stockholm
Sweden

Mathias H. Andersson
Dept. of Zoology
Stockholm University
S-106 91 Stockholm
Sweden

Recommended format for purposes of citation:

Mueller-Blenkle, C., McGregor, P.K., Gill, A.B., Andersson, M.H., Metcalfe, J., Bendall, V., Sigray, P., Wood, D.T. & Thomsen, F. (2010) Effects of Pile-driving Noise on the Behaviour of Marine Fish. COWRIE Ref: Fish 06-08, Technical Report 31st March 2010

Copyright statement:

- © COWRIE Ltd.
- ISBN 978-0-9561404-9-4
- Published by Cefas on behalf of COWRIE Ltd.

This publication (excluding the logos) may be re-used free of charge in any format or medium. It may only be re-used accurately and not in a misleading context. The material must be acknowledged as COWRIE copyright and use of it must give the title of the source publication. Where third party copyright material has been identified, further use of that material requires permission from the copyright holders concerned.

Table of Contents

1	Executive Summary	1
2	Introduction	2
3	Methodology	4
3.1	Field base	4
3.2	Experimental mesocosms	4
3.3	Sound pressure recording equipment	5
3.4	Particle motion measurements	6
3.5	Sound playback system.....	8
3.6	Acoustic tracking equipment.....	8
3.7	Current meter.....	9
3.8	Experimental plan.....	9
3.9	Sound samples	11
3.10	Experimental fish	13
3.11	Fish tagging	15
3.12	Fish transport to the mesocosms	17
3.13	Evaluation methods	18
4	Results	20
4.1	Hydroacoustics	20
4.1.1	Background noise at the field site.....	20
4.1.2	Sound field during playback	20
4.1.3	Particle motion	23
4.1.4	Current meter data.....	26
4.2	Behavioural experiments	27
4.2.1	Overview of behavioural response	27
4.2.2	Swimming speed	28
4.2.3	Directional movement.....	32
4.2.4	Response thresholds	34
4.2.5	Habituation.....	34
5	Discussion	35
5.1	Did our experimental setup work?	35
5.2	Hydroacoustics	36
5.3	Behavioural response in cod and sole.....	37
5.4	Implications for environmental management.....	40
5.5	Future studies and improvement of design	41
6	Conclusions	43
7	Acknowledgements	43
8	References	44
9	Appendix	47

Tables and Figures

Figure 1: Wind farm locations around the UK and neighbouring areas	2
Figure 2: Location map of the Ardtoe site chosen for the mesocosm study.	4
Figure 3: Design of one of the two identical mesocosms.....	4
Figure 4: The mesocosms with positions of hydrophones, particle motion sensor, loudspeaker, VRAP-buoys and working platform.....	5
Figure 5: Assembly of platform.....	5
Figure 6: Platform installed carrying the box containing hydrophone equipment.	5
Figure 7: Set-up for the sound recording system.	6
Figure 8: Pelicase containing equipment for sound recording.	6
Figure 9: Hydrophone installed at the mesocosm.....	6
Figure 10: Sketch of the particle sensor; underwater unit with amplifiers, filters and line drivers.....	7
Figure 11: Sound playback system.....	8
Figure 12: Winch to lower the loudspeaker from the boat.....	8
Figure 13: In air testing of VRAP-buoy system.	9
Figure 14: VRAP buoy before hydrophone cable was brought to the sea bed.....	9
Figure 15: Experimental set up in alternating trials.....	10
Figure 16: Example for pile-driving pulses recorded with the hydrophone system	12
Figure 17: Spectrum of a pile-driving pulse recorded during playback	12
Figure 18: Spectrogram of four pile-driving pulses recorded during playback.....	13
Figure 19: Sketch of the 10 m sole tank containing four 1 m tanks	14
Figure 20: Tagging of cod.	16
Figure 21: Tagging of sole.	17
Figure 22: Fish were transferred from the tank into rectangular net cages.	17
Figure 23: Example for circular statistics.	19
Figure 24: Average background noise at the mesocosm site	20
Figure 25: Peak sound pressure levels at different distances from the sound source compared to calculated transmission loss.....	21
Figure 26: Received peak sound pressure levels in 45 m distance from the sound source.	22
Figure 27: Average sound pressure level measured at four different hydrophones	22
Figure 28: Difference between sound pressure levels in both mesocosms.....	23
Figure 29: Spectrogram of ambient noise (particle motion) in the sea and the holding tanks.....	24
Figure 30: Propagation of particle acceleration at the field site	25
Figure 31: Spectrogram of 0.1 seconds of a recorded piling pulse.....	26
Figure 32: Two examples for current meter data.	26
Figure 33: Example output from the VRAP software.....	28
Figure 34: Number of individual movement observations of A: sole and B: cod.....	28
Figure 35: Mean step speed within the periods of trial for sole that experienced sound for 2 to 5 times.	29
Figure 36: Mean step speed within the periods of trial for cod that experienced sound for 3 to 5 times.	30
Figure 37: Change in step speed between the variables Before, BtoD, During, DtoA and After. Explanations see text above.....	31
Figure 38: Examples for individual reactions of different cod to sound.....	32
Figure 39: Directional response of sole to the 1 st playback in the near mesocosm.....	33
Figure 40: Directional response of cod to 1 st playback in the near mesocosm.....	33
Figure 41: Directional response of cod to 3-5 playbacks in the far mesocosm	33
Figure 42: Lower and upper range of behavioural response of both fish species	40

Table 1: Experimental plan.....	11
Table 2: Background noise in earlier holding tanks of cod.....	14
Table 3: Background noise in sole tank	15
Table 4: Background noise in the small tanks contained in the sole tank.....	15
Table 6: Peak particle acceleration during trials.....	24
Table 7: Overview of experimental trials.	27
Table 8 Overview of the objectives and relevant results of the study.	43

1 Executive Summary

Studies on the effects of offshore wind farm construction on marine life have so far focussed on behavioural reactions in porpoises and seals. The effects on fish have only very recently come into the focus of scientists, regulators and stakeholders. Pile-driving noise during construction is of particular concern as the very high sound pressure levels could potentially prevent fish from reaching breeding or spawning sites, finding food, and acoustically locating mates. This could result in long-term effects on reproduction and population parameters. Further, avoidance reactions might result in displacement away from potential fishing grounds and lead to reduced catches. However, reaction thresholds and therefore the impacts of pile-driving on the behaviour of fish are completely unknown.

We played back pile-driving noise to cod and sole held in two large (40 m) net pens located in a quiet Bay in West Scotland. Movements of the fish were analysed using a novel acoustic tracking system. Received sound pressure level and particle motion were measured during the experiments.

There was a significant movement response to the pile-driving stimulus in both species at relatively low received sound pressure levels (sole: 144 – 156 dB re 1 μ Pa Peak; cod: 140 – 161 dB re 1 μ Pa Peak, particle motion between 6.51×10^{-3} and 8.62×10^{-4} m/s² peak). Sole showed a significant increase in swimming speed during the playback period compared to before and after playback. Cod exhibited a similar reaction, yet results were not significant. Cod showed a significant freezing response at onset and cessation of playback. There were indications of directional movements away from the sound source in both species. The results further showed a high variability in behavioural reactions across individuals and a decrease of response with multiple exposures.

This study is the first to document behavioural response of marine fish due to playbacks of pile-driving sounds. The results indicate that a range of received sound pressure and particle motion levels will trigger behavioural responses in sole and cod. The results further imply a relatively large zone of behavioural response to pile-driving sounds in marine fish. Yet, the exact nature and extent of the behavioural response needs to be investigated further. Some of our results point toward habituation to the sound.

The results of the study have important implications for regulatory advice and the implementation of mitigation measures in the construction of offshore wind farms in the UK and elsewhere. First, the concerns raised about the potential effects of pile-driving noise on fish were well founded. This suggests to both regulators and developers that the costs imposed by some mitigation measures that have so far been applied following the precautionary principle go some of the way to addressing a real problem. We also suggest that our behavioural thresholds are considered in assessments of impacts of offshore wind farms in the UK and elsewhere. Mitigation measures should be further discussed developed and, if meaningful, applied especially if these could lead to a reduction of acoustic energy that is emitted into the water column.

Further studies should investigate the response at critical times (e.g. mating and spawning) and the effects of pile-driving on communication behaviour. It will also be necessary to further investigate habituation to the sound to effectively manage effects of pile-driving sound on marine fish.

2 Introduction

The effect of anthropogenic underwater sound on marine life has become an important environmental issue. Sound speed in water exceeds that in air by a factor of about 4.5 and absorption is less compared to air. Consequently many marine organisms are very well adapted to emit and receive sound and they use it for a variety of functions such as communication, to locate mates, to search for prey, to avoid predators and hazards, and for short- and long-range navigation (Janik 2009, Popper & Hastings 2009a, Tyack & Clark 2000). Sound that is generated during various human activities such as offshore construction, shipping, military exercises and seismic surveys has the potential to interfere with marine life and can lead to a range of effects from very subtle behavioural changes to death, depending on the physical properties of the received sound (OSPAR 2009).

One activity that is increasingly in the focus of scientists, regulators and stakeholders is the construction of offshore wind farms. As can be seen in Figure 1, plans for offshore wind farm developments in the UK and adjacent areas are continuously expanding and the question of impacts arising from offshore wind farm developments is therefore a pressing one for regulators, not only in light of the Round 3 offshore wind farm developments in the UK, but all over Northern Europe.

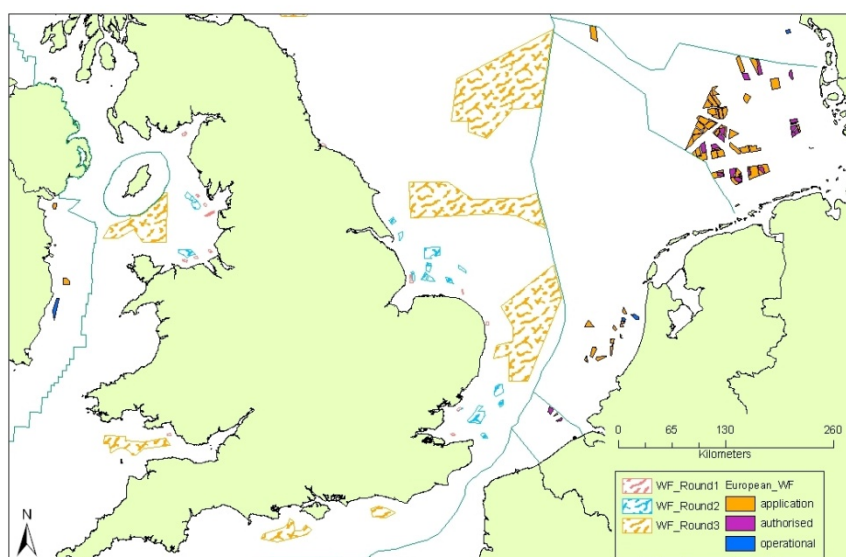

Figure 1: Wind farm locations around the UK and neighbouring areas (Source: A. Judd, Cefas, with permission).

Of most concern is the pile-driving that is carried out during construction activities. Sounds created during impact pile-driving comprise very high source sound pressure levels of more than 250 dB re 1 μ Pa (OSPAR 2009). While the effects of pile-driving sound on near shore cetaceans, such as the harbour porpoise have been the subject of some initial research at Danish offshore wind farm sites, very little is known about whether there is any influence on fish (reviews by OSPAR 2009, Popper & Hastings 2009a, Thomsen *et al.* 2006). Studies so far indicate that pile-driving sound could kill or injure fish in the close vicinity of the construction site and it seems plausible that temporary hearing loss could occur at slightly farther ranges, depending on whether fish would move in response to the sound (see OSPAR 2009, Popper & Hastings 2009a, Thomsen & Judd in press). Yet, the amount of fish acutely affected in any such cases might be small especially when comparing the numbers taken by the fishing industry at any given time (Thomsen & Judd in press).

The ecological consequences of behavioural disturbance due to pile-driving might be a very different story though. Studies have shown clear behavioural reactions of fish to a variety of sounds, sometimes at relatively low received sound pressure levels (reviews by Hastings & Popper 2005, Popper &

Hastings 2009b, a, Thomsen *et al.* 2006, see Mueller-Blenkle *et al.* Submitted). Thomsen *et al.* (2006) and Thomsen & Judd (in press) estimate that cod and herring could perceive pile-driving sounds over very large distances of at least 80 km from the source. Species with a poorer sensitivity such as salmon (*Salmo salar*) and flatfish might also detect pile-driving sound at considerable distance. Thomsen *et al.* (2006) further suggest that behavioural responses due to pile-driving noise might happen anywhere within the zone of audibility and that the responses could potentially prevent fish from reaching breeding or spawning sites, finding food, and acoustically locating mates. The ecologically significant result could be long-term effects on reproduction and survival in species that are subject to national or international conservation efforts and/or commercial interest such as sole, cod and herring. Further, avoidance reactions might result in displacement away from potential fishing grounds and result in reduced catches as has been shown to be the case in cod due to seismic survey activity (Engås *et al.* 1996). Yet, studies on the effects of pile-driving on the behaviour of fish are limited to two investigations, both with highly equivocal results due to the experimental setup used (for a critical review see Popper & Hastings 2009a). The resulting uncertainty has complicated the pre-construction environmental assessments and the post-construction environmental management of offshore wind farms to a great extent. In the UK, for example, licensing offshore wind farms has turned out to be challenging and time consuming, especially when restrictions to construction activities currently have to be applied based on precautionary measures.

The objective of this project was to perform experimental research on effects of pile-driving noise on cod and sole. The study was intended to improve the understanding of the threshold of exposure that lead to behavioural responses in commercially important fish. A further objective was to define the characteristics, the scale and the duration of responses as a function of sound exposure. Finally, the study aimed to interpret the results in light of pile-driving operations in the marine environment. The results of the study shall guide regulatory advice and the implementation of mitigation measures in the construction of offshore wind farms in UK waters.

3 Methodology

3.1 Field base

Experiments were carried out using the facilities of Viking Fish Farms Ltd, Ardtoe Marine Laboratory, West Scotland (Figure 2). These facilities included large holding tanks for fish, a Home Office approved room for fish tagging and logistical and technical support.

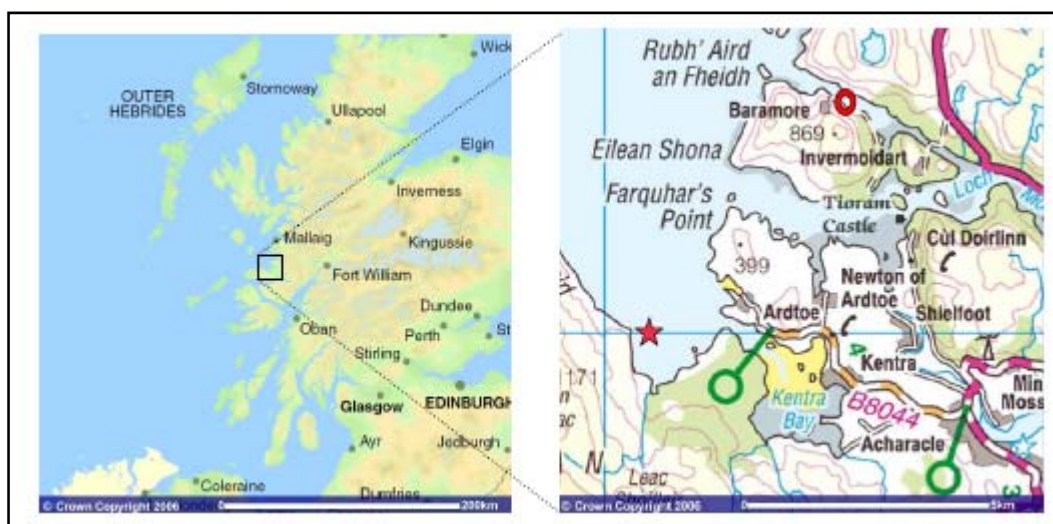

Figure 2: Location map of the Ardtoe site chosen for the mesocosm study. (Red star: Loch Cenn Traigh approximate location of the mesocosms (© Crown Copyright 2006)).

3.2 Experimental mesocosms

The field site for the research project was located in Loch Cenn Traigh near Ardtoe (see Figure 2). Two large net pens (known as 'mesocosms'), each 40 m diameter x 5 m high, were installed on the sea bed 15 m apart at this site for the COWRIE 2.0 EMF Study in 2007 (Figure 3).

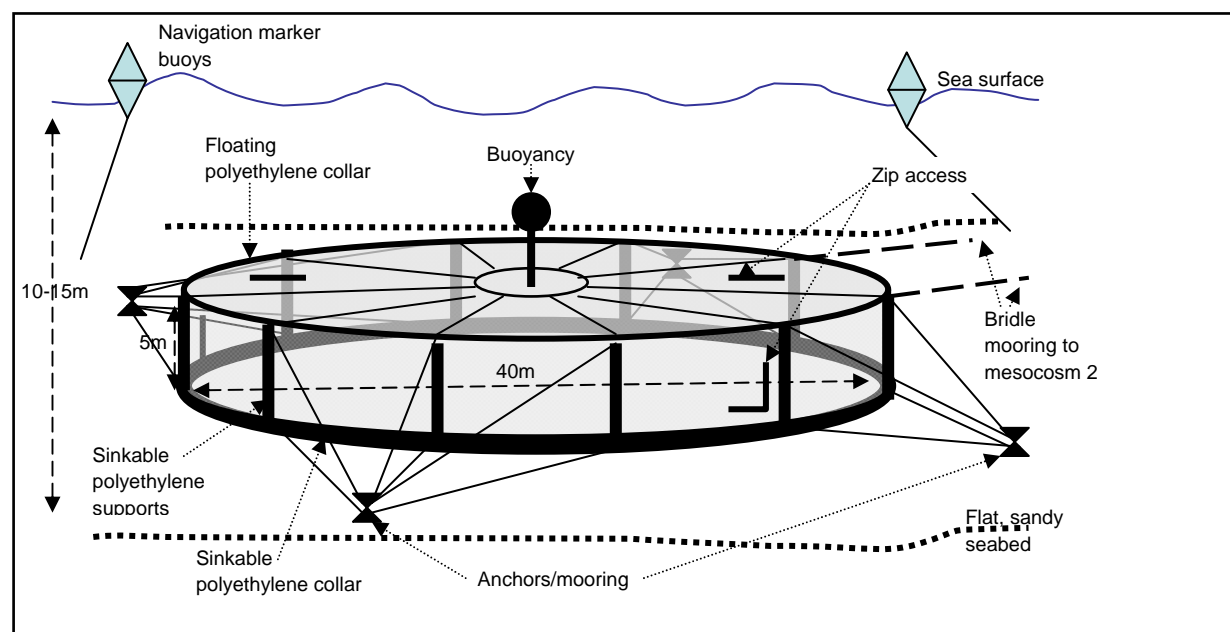

Figure 3: Design of one of the two identical mesocosms (©ABGill).

The seabed at the mesocosm site is relatively flat and shallow, characterised by the presence of patchy mixed algal cover lying over a range of sediment types, including muddy sand, clean fine and medium sands and mixed sediments of sand, gravel and shell. Depth ranges between 10 and 15 m with a 4.2 m tidal range and a slope of around 1 m in 50 m (conservative estimate). Before the experiments could begin maintenance and repair work for the mesocosms was carried out by professional divers between December 2008 and April 2009. Additional work to prepare the site for the experiments was carried out during May to July 2009 including the installation of a working platform (housing the hydrophone equipment), four stationary hydrophones and two mooring points for loudspeaker installation. Figure 4 shows the position of installed equipment at the mesocosm site. Photographs showing the working platform can be found in Figure 5 and Figure 6.

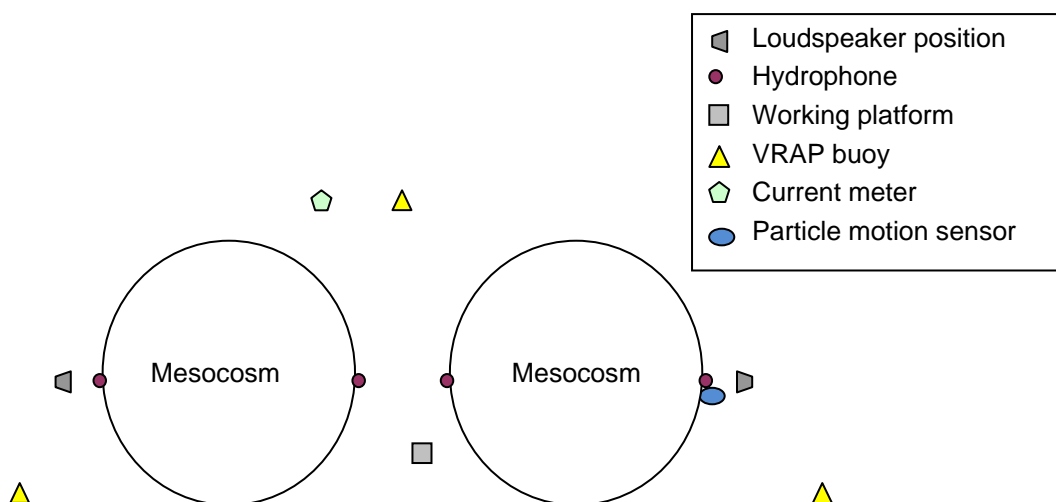

Figure 4: The mesocosms with positions of hydrophones, particle motion sensor, loudspeaker, VRAP-buoys and working platform.



Figure 5: Assembly of platform.

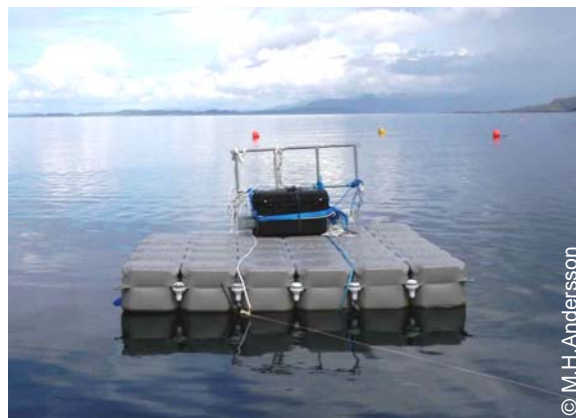

Figure 6: Platform installed carrying the box containing hydrophone equipment.

Admiralty approved navigation buoys that mark the site and their moorings were checked in December 2008.

3.3 Sound pressure recording equipment

The recording system for the playback trials comprised four Reson TC4013 hydrophones and TC4013-12/VP1000 amplifiers connected to a Dell Inspiron Mini 10 laptop running “Raven” sound recording software. A large waterproof case contained the preamplifiers and amplifiers for the hydrophones, a leisure battery as power supply and the laptop to record the data. The hydrophone cables

were led through watertight cable glands to the rear of the box. Figure 7 shows a diagram of the sound recording equipment while Figure 8 shows the actual set-up inside of the equipment box. The sound recording system was housed on a floating platform (Figure 6) between the mesocosms.

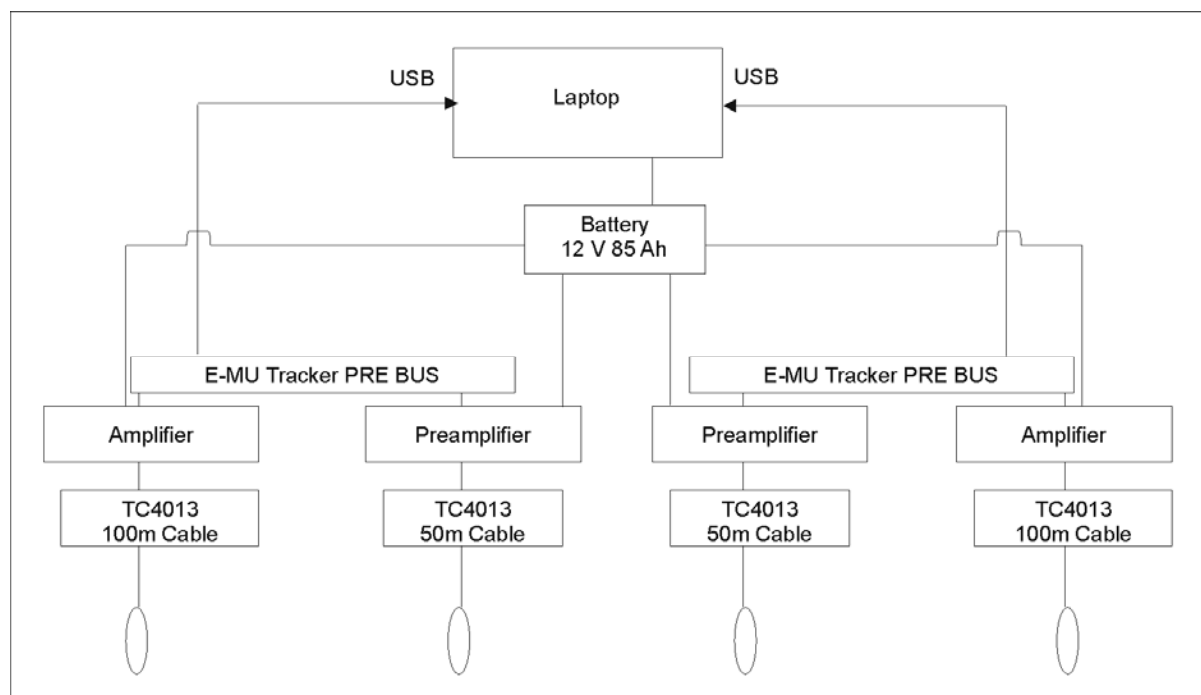

Figure 7: Set-up for the sound recording system.

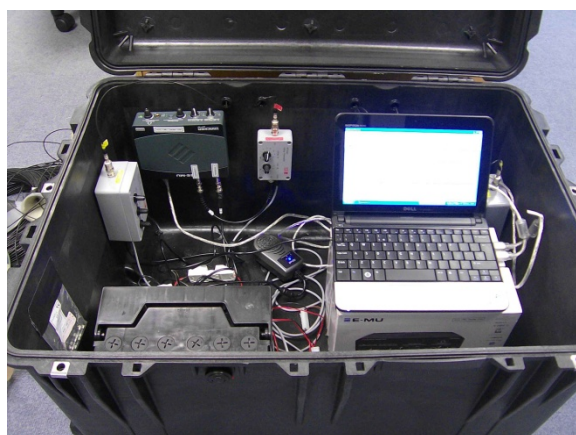

Figure 8: Pelicase containing equipment for sound recording.

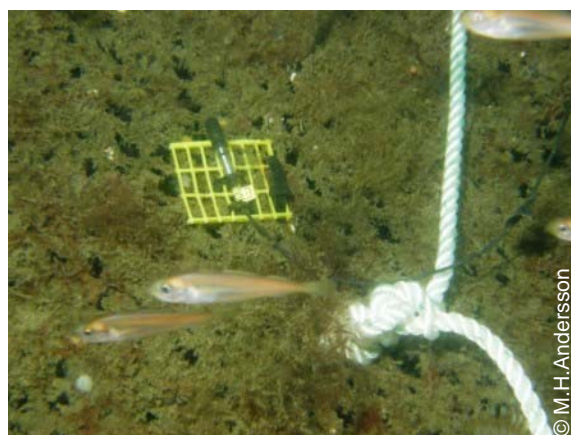

Figure 9: Hydrophone installed at the mesocosm.

Hydroacoustic measurements were carried out during experiments using hydrophones attached to the mesocosms (see Figure 4 and Figure 9) giving sound pressure levels at certain distances from the loudspeaker.

3.4 Particle motion measurements

Particle motion was measured as well during the field trials. A novel instrument measuring particle acceleration was used that was developed by the Department of Meteorology at Stockholm University and the Swedish Defence Research Agency (Sigray *et al.* 2009). The instrument consisted of an underwater and a dry unit (Figure 10). The particle sensor (three seismic accelerometers) was connected to the underwater unit via a 5 m cable. The system was designed to measure particle acceleration in the frequency range of 0.1-300 Hz. During trials, a sampling frequency of 800 Hz was

employed. The underwater unit contained amplifiers, filters and line drivers. The above water and underwater units were connected with a 60 m long cable. The dry unit consisted of power amplifiers, receiver, analogue/digital converter and a recording device (laptop). The whole system was powered by a 12 V marine battery.

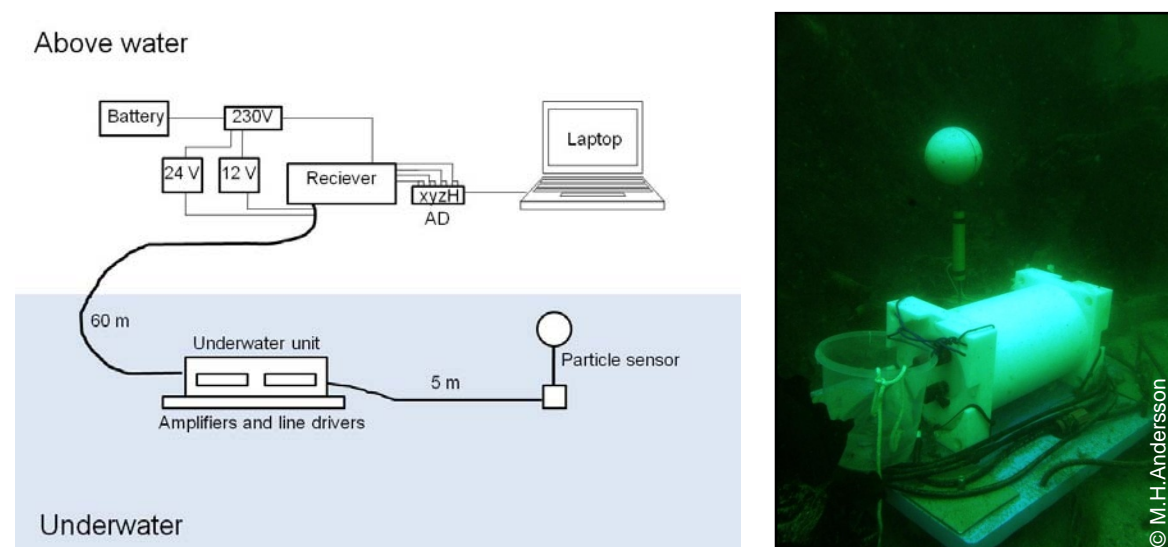

Figure 10: Sketch of the particle sensor; underwater unit with amplifiers, filters and line drivers.

Measurements

The underwater unit was placed on the sea floor with the accelerometers suspended 0.9 m up in the water column. It was positioned to be aligned vertically with hydrophone 4 (Figure 4). The distance from the loudspeaker varied between 5-10 m during trials. Recordings of transmitted piling noise and ambient noise were made throughout the first part of the experiments (cod group 1) in July and beginning of August 2009. Additional measurement at different distances from the sound source (6, 10, 15, 20, 25, 30, 60 and 110 m) were carried out before and after the first set of trials in order to measure the particle acceleration as a function of distance from the loudspeaker.

Data analysis

Recordings of particle acceleration were analysed using Matlab (MathWorks) signal processing software. Only the radial x-axis component was used in the calculations of peak and amplitude values as it was the dominate component with much higher values than the Y and Z axis. A high-pass filter was applied in the post-analysis to attenuate the wave-induced motions (< 10 Hz) that were dominating the signal. Each 10 minute playback sequence contained an average of 524 pile strikes and average peak values (including standard deviation) were calculated and presented in units of m/s^2 . Amplitudes of ambient noise in the sea and in holding tanks of the fish were presented as m/s^2 rms (root mean square) values. Statistical analyses were performed using SPSS 13.0 statistical software for Windows. Differences between playback levels (highest level, -6 dB, -12 dB) were analysed using the non-parametrical Kruskal-Wallis ANOVA as data were not normally distributed. Additionally, a correlations analysis (Pearson) was performed to evaluate any depth dependency during sound measurements. An analysis of influence by sea state could not be carried out due to low replication level of different weather during particle acceleration measurements.

3.5 Sound playback system

A J11 loudspeaker manufactured in the USA was purchased for the experiments as this loudspeaker is particularly strong in frequencies up to 10 kHz and so most suitable for playback of pile-driving sound. Sound pressure levels of up to 170 dB re 1 μ Pa could be produced during playback. The loudspeaker was delivered to Cefas in May 2009 and initial tests showed a very high quality of playback performance.

For the playback experiments the loudspeaker was connected to a car audio amplifier and a transformer to produce high sound levels, and a further amplifier which was connected to a laptop from which sound was played back. The sound playback system was powered by a leisure battery and stored in a waterproofed container (Figure 11).

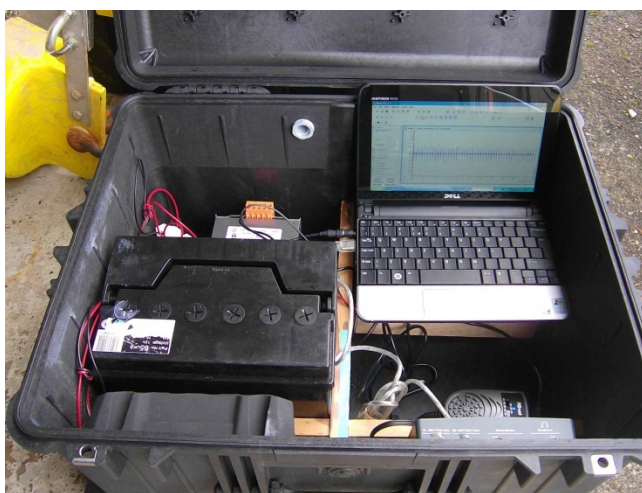

Figure 11: Sound playback system.



Figure 12: Winch to lower the loudspeaker from the boat.

3.6 Acoustic tracking equipment

During experiments movements of fish were recorded using an acoustic tracking system VRAP (Vemco Radio Acoustic Positioning). The VRAP system uses three acoustic tracking buoys (Figure 13) that detect the acoustic pulses from tagged fish, triangulates the fish position and then relays the data to a base station via a radio link. Each buoy has an internal battery which provides power for up to 10 days. Therefore, over the course of the experiments, the buoys needed to be recharged periodically using a mains charger back on land.

The VRAP buoys were moored to concrete blocks at the sea bed in a triangular position outside the two mesocosms (see Figure 4). The average water depth (varying with tide) on the two buoys closer to the coast was 12 m while it was 15 m at the buoy furthest from the coast. The hydrophone cables were attached to the mooring rope with the hydrophone floating about 1 m above the seafloor. Figure 14 shows a VRAP buoy with the coiled up hydrophone cable at the mesocosm site before the hydrophone was attached to the mooring rope.



Figure 13: In air testing of VRAP-buoy system.

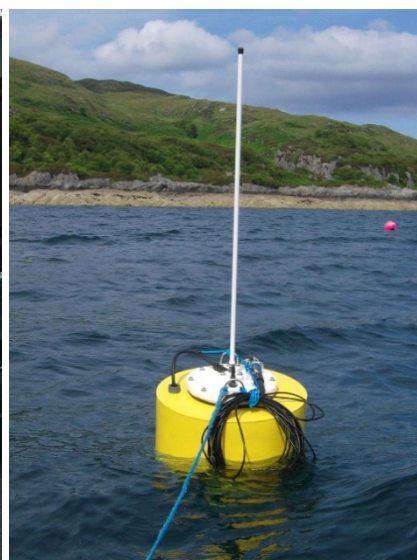

Figure 14: VRAP buoy before hydrophone cable was brought to the sea bed.

We used VEMCO V9 acoustic pingers/tags for the experiments. Each tag transmits on one of eight frequencies in a range between 63 and 84 kHz. Tags were programmed to transmit on one day in an 8-day cycle, so, for example, tags 1-8 transmitted on days 1, 9, 17, 25, 33 etc. while tags 9-16 transmitted on days 3, 11, 19, 27 etc. and so on. Therefore different fish were observed on different experiment days (see 3.8 and Table 1).

Using the VRAP system one fish position could be monitored about every 22 seconds. With four fish being monitored during trial the position of a single fish was taken about every 90 second. This cycle became shorter when less fish were monitored (e.g. every 45 seconds using two fish).

The 8-day cycle conserves battery life and allowed the same tags to be used for the whole field season for experiments with cod and sole. Additionally this arrangement allowed the experiments to be repeated over several cycles if necessary. To save further energy, the fish tags only emitted signals for 18 hours a day during day light hours.

Five groups of eight tags were purchased for four experimental fish groups together with a spare set. Generally, the tags performed well and a sufficient number could be recovered each time to perform all three sets of experiments (cod, sole and cod). Yet, due to some inevitable losses the number of fish investigated was reduced from 32 in the first set of experiments to 15 by the third set. However, the reduced number of subjects was offset by a much higher resolution in time, providing important additional insights on the movement of the fish before, during and after playback.

3.7 Current meter

A current meter (FSI 2d ACM) to measure currents and temperature was deployed on site approximately halfway along the seaward edge of the mesocosm site shortly before the start of the first experiment (see Figure 4).

3.8 Experimental plan

Two mesocosms were used for the experiments with a distance of 15 m between them. While sound was played back from one side of one mesocosm exposing the fish to high sound levels the sound level in the second mesocosm was much lower (Figure 25) exposing groups of fish to different sound fields in the same experiment. Additionally the near mesocosm provided an environment with much

stronger sound pressure gradient than the distant one allowing fish to avoid highest sound levels by moving into other parts of the mesocosm. The experimental design was developed using VEMCO VRAP tags (see section 3.6) and selective data recording of tagged fish during different trials. Eight new fish were added to the mesocosms every other day without removing the fish from earlier trials. The advantage of this protocol was that the newly released fish that were monitored the next day hadn't experienced the sound before and therefore the reaction was not influenced by possible habituation.

Six trials were performed on every experimental day, observing the behaviour of two alternating groups of four fish each (two in each mesocosm) at a time. Sound was played back from two different positions on either side of the mesocosms moving the loudspeaker between trials (Figure 15). The red trapezoid in the figure shows the active loudspeaker. Every trial consisted of a 10 minute sound playback and 10 minutes pre- and post-playback. This allowed comparisons of the periods with and without sound with respect to the fish swimming speed, swimming direction and location in the mesocosm.



Figure 15: Experimental set up in alternating trials. Trial 1: Sound playback from position 1; monitored fish in each mesocosm are framed. Trial 2: Sound playback from position 2 while the other fish (marked with frames) are monitored.

Playbacks of a range of pile-driving sounds (see section 3.9) at different sound pressure levels were used, thereby exposing the fish in both mesocosms to different sound fields. The original experimental schedule contained four experimental days (with six trials each) over a period of eight days. Some adaptations had to be made due to the loss of one group of cod (due to problems in one holding tank) and poor weather that made it necessary to reduce the number of trials on some days. To compensate for these reductions the first experimental set was repeated and one

experimental day added to the sole experiments. Table 1 shows the experimental plan for duration of four experimental days.

Table 1: Experimental plan showing the combination of different sound samples, sound pressure levels (SPL), loudspeaker position and the fish equipped with different frequency tags in 24 trials.

Sound	Pressure	Position	Group 1, days 1, 9, 17 etc	Sound	Pressure	Position	Group 2, days 3, 11, 19 etc				
Trial 01	A	1	1	1 a	2 e	Trial 07	G	1	2	9 a	10 e
				3 b	4 f					11 b	12 f
Trial 02	B	1	2	5 c	6 g	Trial 08	H	1	1	13 c	14 g
				7 d	8 h					15 d	16 h
Trial 03	C	2	1	1 a	2 e	Trial 09	I	2	2	9 a	10 e
				3 b	4 f					11 b	12 f
Trial 04	D	2	2	5 c	6 g	Trial 10	J	2	1	13 c	14 g
				7 d	8 h					15 d	16 h
Trial 05	E	3	1	1 a	2 e	Trial 11	K	3	2	9 a	10 e
				3 b	4 f					11 b	12 f
Trial 06	F	3	2	5 c	6 g	Trial 12	L	3	1	13 c	14 g
				7 d	8 h					15 d	16 h

Sound	Pressure	Position	Group 3, days 5, 13, 21 etc	Sound	Pressure	Position	Group 4, days 7, 15, 23 etc				
Trial 13	M	1	1	17 a	18 e	Trial 19	S	1	2	25 a	26 e
				19 b	20 f					27 b	28 f
Trial 14	N	1	2	21 c	22 g	Trial 20	T	1	1	29 c	30 g
				23 d	24 h					31 d	32 h
Trial 15	O	2	1	17 a	18 e	Trial 21	U	2	2	25 a	26 e
				19 b	20 f					27 b	28 f
Trial 16	P	2	2	21 c	22 g	Trial 22	V	2	1	29 c	30 g
				23 d	24 h					31 d	32 h
Trial 17	Q	3	1	17 a	18 e	Trial 23	W	3	2	25 a	26 e
				19 b	20 f					27 b	28 f
Trial 18	R	3	2	21 c	22 g	Trial 24	X	3	1	29 c	30 g
				23 d	24 h					31 d	32 h

tag frequencies	
a	63 Hz
b	69 Hz
c	66 Hz
d	72 Hz
e	75 Hz
f	81 Hz
g	78 Hz
h	84 Hz

24 different sound samples were used (A-X) that were played back in three different pressure levels (1-3 with 1 being the highest level) from two different positions on either side of the mesocosms (Figure 15). Each experimental group contained 8 fish equipped with tags emitting on different frequencies (see box below, right) but only the data of 4 fish were recorded in one trial for higher data resolution.

3.9 Sound samples

High quality sound recordings of pile-driving from the construction of the German research platform Fino 1 (Jacket-pile construction, 1.5 m diameter, sandy bottom, water depth ~ 30 m) were provided by the Institute for Applied and Technical Physics (ITAP) in Oldenburg, Germany. The approximately 50 minute recording was cut into 10 minute sound samples, each starting at a different time (e.g. minute 1-10, 2-11 etc.). These samples were randomly presented in the different trials but making sure that the same sound sample was not presented twice at the same sound pressure level. Such a pattern of use of playback stimuli avoids the problem of pseudoreplication (McGregor 2007), i.e. differences in the subjects' responses can be attributed to the sound pressure level of playback and not to particular characteristics of the stimuli.

The sound pressure levels presented to the fish of up to 156 dB re 1 μ Pa are comparable to sound at relatively large distance from a pile-driver.

Underwater pile-driving sounds are characterized by multiple rapid increases and decreases in sound pressure over time. Figure 16 shows pile-driving pulses from the existing recording used for the play-

backs showing a very brief event of high sound amplitude that lasts only about 0.1 seconds with a repetition every about 1.1 to 1.2 seconds.

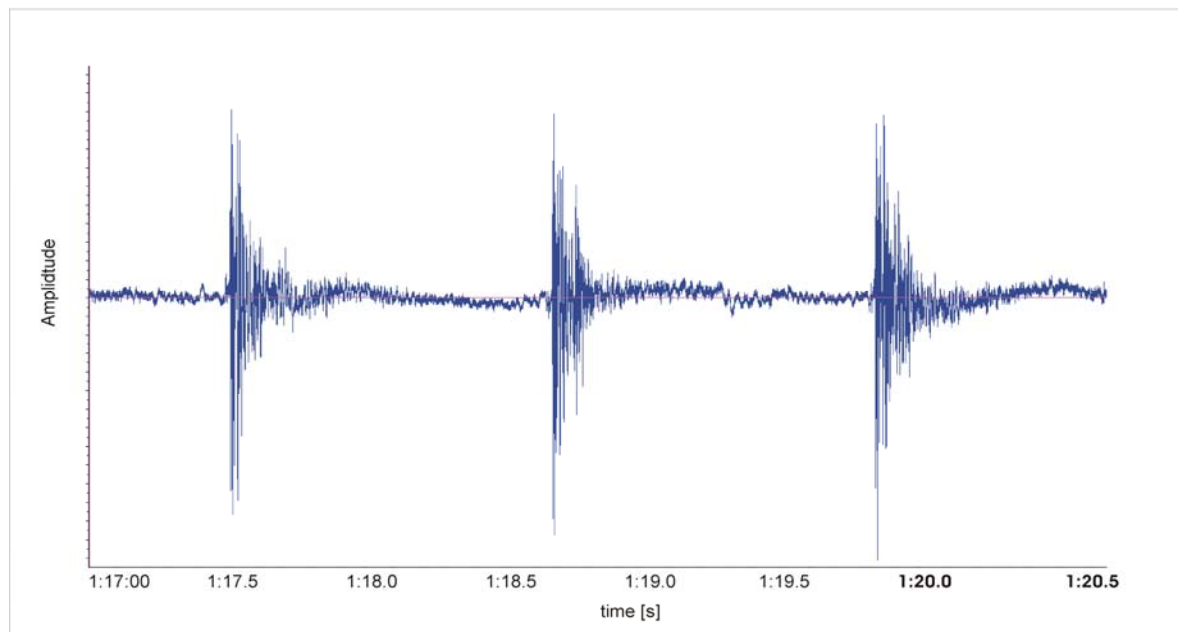

Figure 16: Example for pile-driving pulses recorded with the hydrophone system in approximately 7 m distance from the loudspeaker.

A pile-driving signal contains mostly low frequencies up to 3000 Hz with highest energy at frequencies between about 170 and 1100 Hz. Figure 17 shows an example of a played back piling pulse recorded during trials at a distance of about 7 m from the sound source.

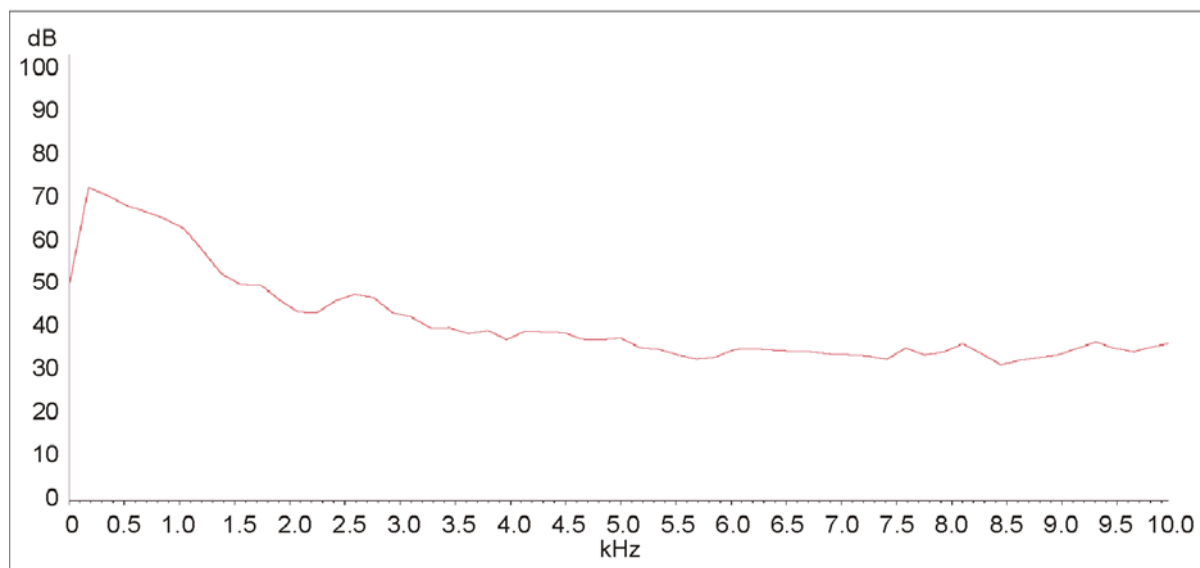

Figure 17: Spectrum of a pile-driving pulse recorded during playback at a distance of 7 m from the loudspeaker.

A spectrogram of the same recording shows four piling pulses (Figure 18). From the picture it is clear, that the signal shows highest energy at the low frequencies but that it contains even high frequencies of up to about 13 kHz and that the signal is clearly distinguishable from background noise.

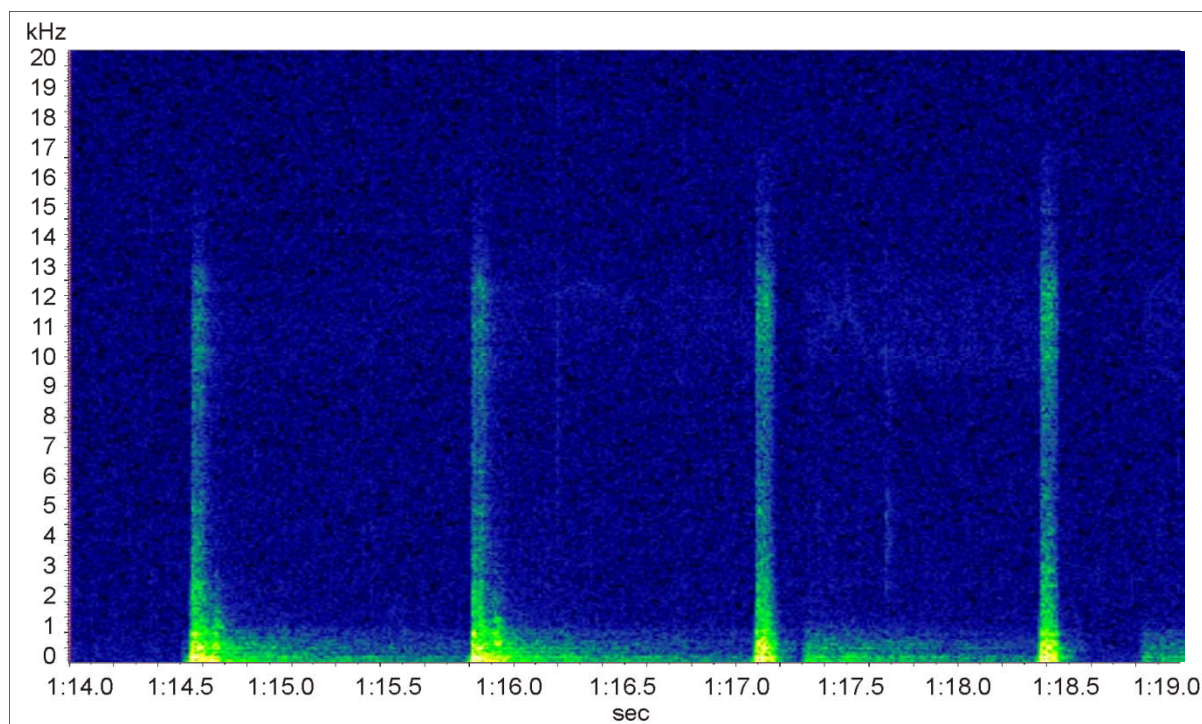

Figure 18: Spectrogram of four pile-driving pulses recorded during playback at a distance of 7 m from the loudspeaker.

3.10 Experimental fish

We decided to start the experiments using farmed cod (*Gadus morhua*) from the Ardtoe facility (Viking Fish Farms Ltd) followed by tests on wild-caught Dover sole (*Solea solea*). We planned for a third set of experiments using wild-caught cod which we had expected to obtain from Millport specimen supply, Isle of Cumbrae. In our view, there were significant advantages in this procedure because we were able to refine equipment and procedures early in the experimental schedule with an easily accessible source of fish. The fish used were of the same age class, had experienced the same acoustic environment and were subject to only minimal transportation. When it became clear that insufficient numbers of wild cod would be available in time for the third set of experiments, it was decided to run another experiment using farmed cod to increase statistical power for determining a behavioural response by the fish.

History of cod

The cod used in the experiments were hatched in Ardtoe in May 2007 and the parents were hatchery stock of Ardtoe origin. The fish were kept in 1 m fibreglass tanks in the hatchery and later in the same tank size in the nursery and when they grew bigger they were transferred in a 3 m fibreglass tank in another building. In preparation of the experiments the fish that later became cod group 1 were transferred back into two 1 m tanks in the nursery while the cod of group 2 was transferred to a 3 m tank in the same building. After tagging, four groups of eight fish each were kept in four outdoor 1 m tanks inside a 10 m tank. The fish of cod group 1 (used in July/August) were 31-43 cm, the cod of group 2 36-47 cm in length. The cod were fed on pellets every other day.

History of Sole

The Dover sole were caught by trawl near the island of Tiree about 65 km from Ardtoe on the 3rd of July. The sole (26.4-39.5 cm length) were transferred into a 10 m circular outdoor tank (Figure 19) with a water depth of about 1 m changing slightly with tides. The tank had two aerations, a water inflow which added water just underneath the water surface at high tide and four water inflows which

came from four smaller tanks located within the big tank. The fish were fed on fresh mussels and worms every other day.

Acoustic history of the fish

While being kept in holding tanks, fish are usually exposed to higher sound levels than in the wild. We therefore performed measurements on ambient noise levels in all the tanks where the fish were kept prior to the experiments to investigate pre experimental sound exposure.

Before the experiments in summer 2009, the cod were kept in a 3 m tank before being transferred to the nursery where group 1 was kept in two different 1 m tanks and group 2 in a 3 m tank. Background noise measurements for these tanks are summarized in Table 2. The background noise level in this tank where both cod groups were kept for most of their life prior to the experiments was less noisy compared with all other tanks and comparable to natural conditions (see Figure 29).

Table 2: Background noise in earlier holding tanks of cod.

Holding tank	Near the centre [dB re 1 μ Pa rms]	Near the edge [dB re 1 μ Pa rms]
Big shed 3 m tank (both group of cod)	117	116.2
Nursery 3 m tank (cod group 2)	120.7	122.6
Nursery 1 m tank (cod group 1)	122.3	122.9
Nursery 1 m tank (cod group 1)	122.2	123.8

To gain an understanding of the acoustic environment directly preceding the experiments, the noise level in the big holding tank (see above) was measured at 4 different positions with high water inflow switched on or off. The aeration was switched on during all measurements since it was continuously switched on when fishes were inside the tank. Although the high water inflow appeared to be noisy the measurements showed very similar values with and without water inflow (Table 3)

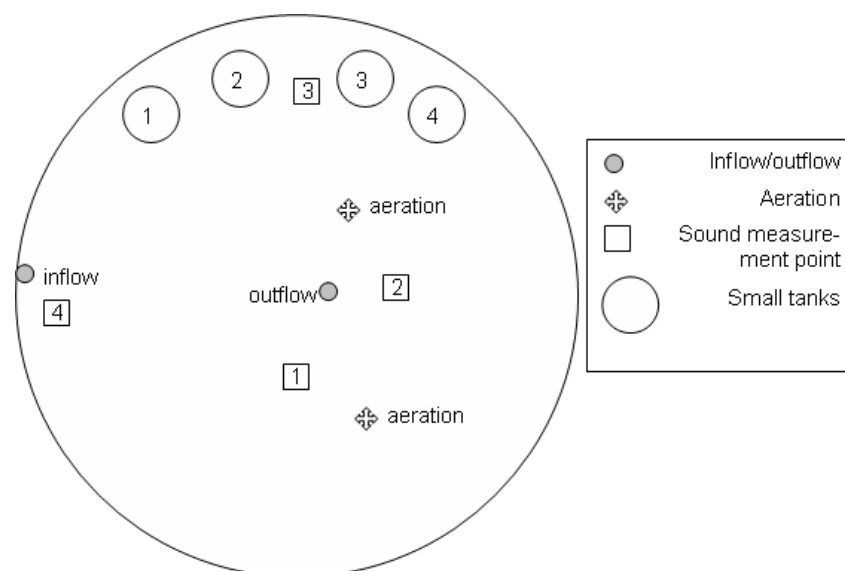

Figure 19: Sketch of the 10 m sole tank containing four 1 m tanks used to keep the four groups of cod.

Table 3: Background noise in sole tank.

Position	With water inflow [dB re 1µPa rms]	Without water inflow [dB re 1µPa rms]
Pos. 1	128.7	128.4
Pos. 2	123.2	125.0
Pos. 3	123.5	122.0
Pos. 4	126.8	125.7

Four smaller tanks were located inside the big tank, which were used to keep the four groups of cod separated from each other after they had been tagged. These tanks were equipped with individual subsurface water supply and aeration. All small tanks were made from fibreglass. The background noise in the small tanks 1-3 was measured at two positions each - near the centre (location of water overflow) and close to the edge of the tank. The results are given in Table 4.

Table 4: Background noise in the small tanks contained in the sole tank.

Tank no.	Near the centre [dB re 1µPa rms]	Near the edge [dB re 1µPa rms]
Tank 1	118.4	122.3
Tank 2	123.2	122.3
Tank 3	119.6	122.4

The background noise level in the small tanks was mostly lower than in the big tank which is likely to be caused by the different tank materials with noise more strongly reflected at the thin metal walls of the big tank.

Particle acceleration in the holding tanks varied both between and within the two tanks. In the large cod tank (5 m diameter) where cod had been kept for more than a year, the amplitude varied between $3.0 \times 10^{-4} \text{ m/s}^2$ (rms) (at the edge) and $1.0 \times 10^{-4} \text{ m/s}^2$ (rms) (in the centre). Additionally, when disturbances from outside the tank were added (walking on walkway, splashing), the levels in the lower frequencies (<50 Hz) slightly increased at the edge of the tank, resulting in a higher total amplitude ($1.0 \times 10^{-3} \text{ m/s}^2$ (rms)). The larger sole tank (10 m diameter) showed somewhat higher levels than the cod tank; $3.0 \times 10^{-3} \text{ m/s}^2$ (rms) (at the edge) and $1.0 \times 10^{-4} \text{ m/s}^2$ (rms) (in the centre), possibly a result of a larger water intake pipe and higher water flow.

The soundscape in the tanks showed a more broadband noise than the background noise in the sea (see chapter 4.1.3, Figure 29). This was presumed to be associated with anthropogenic noise in and around the tanks. No measurements of particle acceleration were performed in the smaller cod tanks standing in the sole tank because they were too shallow for the particle sensor.

3.11 Fish tagging

Intra-peritoneal tag attachment for cod

Intra-peritoneal tagging is only suitable for fish with sufficient space in the body cavity to accommodate the tag without impeding or damaging the internal organs. This method has the benefit of avoiding tag loss that can be associated with external tagging.

Each cod was placed into a 1 m laboratory tank, where its condition could be assessed before tagging was undertaken. When a cod was deemed suitable for tagging with a pinger, it was anaesthetised in a shallow (20 cm) bath containing 2-phenoethanol (0.4 ml l^{-1}) before being weighed, measured and then placed into a 'V'-shaped channel (12 cm wide by 70 cm long by 10 cm deep) cut into a large wetted sponge or towel. The gills were irrigated with sea water using a LVM Amazon in-line pump (L166 x dia. 38 mm), attached to a silicone tube which was placed directly into the mouth of the cod and a wetted towel was placed over head and operculae.

A small (1.5 cm) incision was made directly into the abdomen, and an acoustic tag gently introduced into the peritoneal cavity (Figure 20A). The incision was closed with two or three single sutures using coated vicryl absorbable sutures, and the wound dressed with a mix of antibiotic powder (Cicatrin) and a protective adhering powder (orahesive) to aid healing of the wound and prevention of infection. Additionally cod were externally tagged with a Howitt tag (see Righton *et al.* 2006) to identify individuals for each experimental group (Figure 20B).

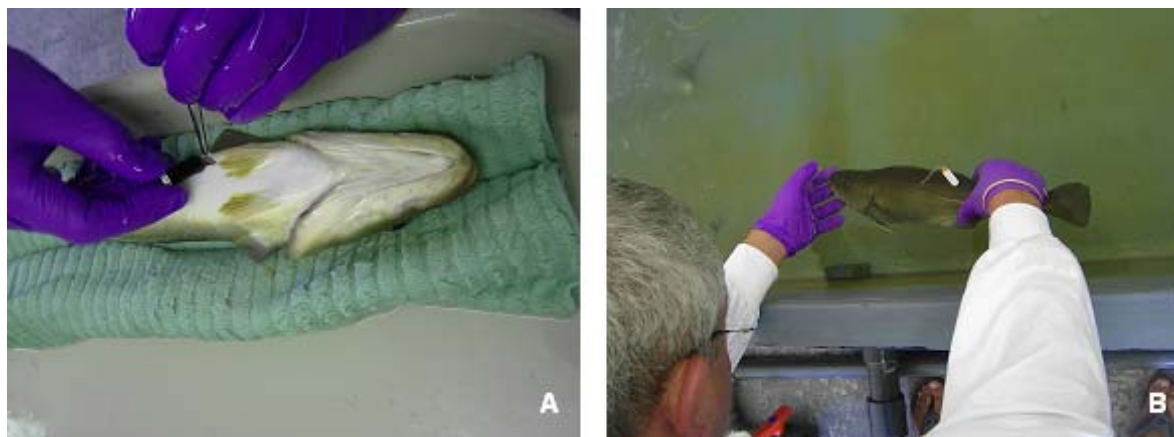

Figure 20: Tagging of cod. A: Insertion of tag. B: Recovery of fish.

Each cod was subsequently allowed to recover from the procedure in the laboratory tank facilities, before being released into 1 m circular outdoor tanks.

External tag attachment for sole

Each sole was placed into a laboratory tank, where its condition could be assessed before tagging was undertaken. When a sole was deemed suitable for external tagging it was anaesthetised in a shallow (20 cm) bath containing 2-phenoxyethanol (0.4 ml/l) before being weighed, measured and then placed onto a large wetted sponge platform and a wetted towel placed over the head and operculae.

We found that the most efficient way to attach the tags was with a cable tie directly to a stainless steel Petersen tagging wire which was then placed directly through a 2.5 cm diameter coloured Petersen Disc (different colours used to identify individuals for each experimental group), which then allowed the tag to lie flush with the skin (Figure 21B). The stainless steel wire was then placed through the body musculature of sole and secured on the ventral surface of the fish by passing through a second Petersen Disc and winding down the wire into a coil as in the standard Petersen tagging method as for Hunter *et al.* (2003). The combination of disc colour and cable tie colour allowed identification of individual fishes. Figure 21A shows the attaching of the disk to a sole and Figure 21B a readily tagged sole with the tag attached to the disk by cable tie.

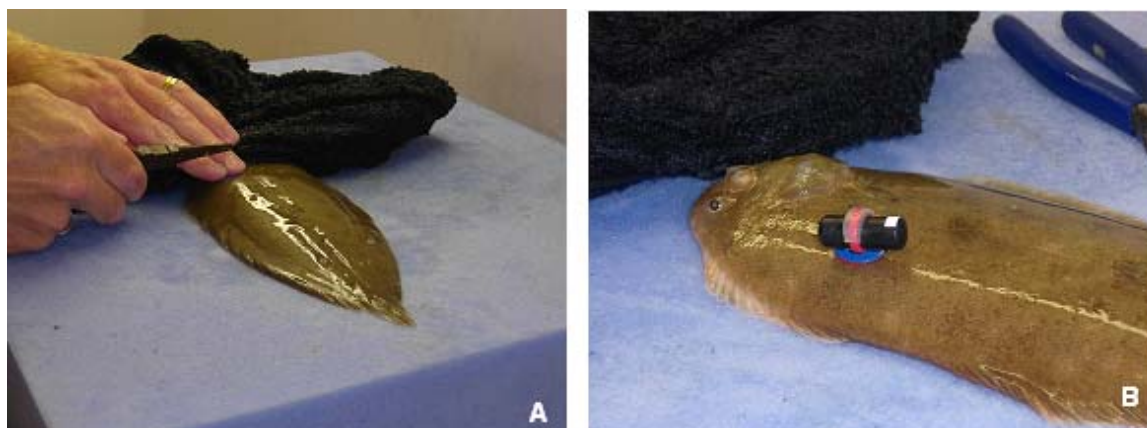

Figure 21: Tagging of sole. A: Attachment of Petersen Disc. B: Tag attached to the disc.

3.12 Fish transport to the mesocosms

To transport the fish to the mesocosms the two groups of fish supposed for each mesocosm were separately placed in small (size) rectangular net cages and transferred into a plastic container (Figure 22A) and then transported to the boat (Figure 22B). During transport on the boat (Figure 22C) the fish were supplied with oxygen. At the mesocosm site the cages were lowered from the platform into the water (Figure 22D) before divers transferred them to the mesocosms. Zippers in the mesocosm nets allowed easy release of fish into the net cages.



Figure 22: Fish transfer into transport cages (A), transport to the boat (B) shipping to the mesocosm site (C) cage lowered from the working platform (D).

3.13 Evaluation methods

Spatial distribution (visual evaluation)

Initially the positional data of individual fish during a period of 30 minutes (10 minutes before, 10 minutes during and 10 minutes after sound playback presentation) were visually interpreted and sorted in three behavioural responses to playback groups.

1. **Stationary:** fish showed virtually no movement (< 5 m) during the 30 minute experimental period.
2. **Movement throughout:** fish showed continuous movement throughout the 30 minute period.
3. **Spatial response:** fish showed a notable change in behaviour after sound playback was started or stopped.

The Animal Movement Analysis Extension to Arcview (AMAE: Hooge & Eichenlaub 2000) was used to estimate the extent of spatial range by generating kernel probability density function surfaces (KPDF) for 95%, 70% and 50% volume estimates under the three-dimensional KPDF surface (see Hooge *et al.* 2000, Seaman & Powell 1996, Worton 1987). The KPDF method is more typically used in studies of territoriality and home range (Jones 2005, Righton & Mills 2006).

Swimming speed of exposure groups

For the statistical analysis the fish were grouped into exposure groups (groups that experienced the same range of sound exposures). It was decided to use exposure groups since the reaction of fish experiencing a sound for the first time can be very different from the reaction when the fish was exposed to the sound before. Hence looking at the fish present in the highest numbers of experiments (i.e. the greatest experience of the sounds) in a separate group might give information about habituation.

In sole, the first group contained only fish that were exposed to the sound for the first time, the second group of fish experienced sound 2 - 5 times and the third group was exposed to 27 or 28 playbacks.

For cod the fish in group 1 experienced the sound for the first time, while the fish in group 2 were exposed to 3 - 5 and the fish in the third group to 14 - 19 playbacks. All individual fish fell into one of these categories and some fell into all. But when fish had more than one trial that belonged in one exposure group, only the trial with the highest experienced sound pressure level was used in the statistical evaluation for reasons of statistical independence. The data of the exposure groups were then divided into "near mesocosm" which was the mesocosm closest to the sound source and "far mesocosm" containing the fish in the mesocosm at the greater distance from the loudspeaker. Inside these groups the average swimming speed of the fish for the different periods before, during and after sound was calculated and compared with each other and with the swimming speed at the beginning of the sound period and the beginning of the after sound period. These swimming speeds were calculated by the distance between the last measurement point in one period to the first point in the next period in relation to time and body length of the fish.

Initial response to sound was evaluated by comparing the average swimming speed before sound to step speed at the beginning of the sound presentation. Step speed BtoD (before to during sound) was measured from the last VRAP-data point value before playback to the first value during playback. Step speed DtoA (during to after) measured the step speed from last value during playback to the first value after playback. These transition values were compared to the periods before and during sound to investigate sudden changes in swimming speed due to sound exposure.

A number of different test were performed using SPSS 12.0.1 for Windows. The specific tests are given within the results.

Swimming speed in individual fish

The swimming speed of sole was evaluated on an individual basis in which the average swimming speed in the three 10 minute periods before, during and after sound presentation were calculated. A reaction was defined as at least doubling or halving of swimming speed between the periods.

Swimming direction (initial response to sound)

In this evaluation the direction of the last step (last two VRAP data points) in the pre-sound period was compared with the first step (first two data points) during sound presentation. The evaluation was carried out for the close and distant mesocosm separately. An Oriana statistical software package (Kovach Computing Services) was used for routine circular statistical methods (Batschelet 1981). Figure 23 shows the output of the program with the mean vector angle as a black bar and circular standard deviation as a red arc.

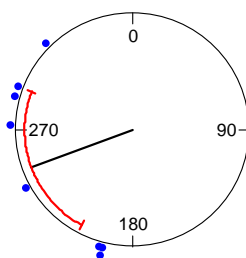

Figure 23: Example for circular statistics. (Blue dots show the swimming direction of the individuals, 0° marks the position of the sound source).

4 Results

4.1 Hydroacoustics

Sound pressure levels were measured continuously during experimental days with the recording system being started before first trial and stopped after the last trial was finished. Therefore, large amounts of hydroacoustic data are available to determine the background noise level and the sound fields during playback experiments. In the following, the acoustic field will be described with and without playback.

4.1.1 Background noise at the field site

The background noise levels at the field site were determined at two different hydrophones at the inner edges of the mesocosms, 15 m apart from each other. The sound levels were calculated from RMS (root mean square) values. Frequencies up to 10 Hz were filtered out since they are related to small movements of the hydrophone and are therefore measurement artefacts. The background noise was evaluated for three different sea states defined by wind and waves. These sea state measurements were estimated during experiments.

As expected the background noise level rose with larger waves and stronger winds (Figure 24). This was partly related to noise generated by the mesocosm structure (that also could be heard clearly) and by the anchor chain of the platform (also audible although large parts of the chain were covered in plastic to reduce noise). On calm days (light wind, waves up to 0.05m) average background noise measured 110 dB re 1 μ Pa (rms). This rose to about 116 dB re 1 μ Pa (rms) with wave heights of 0.05 to 0.4 m with moderate to strong winds and 119 dB re 1 μ Pa (rms) at wave heights between 0.5 and 0.6 m with white caps and moderate to strong winds.

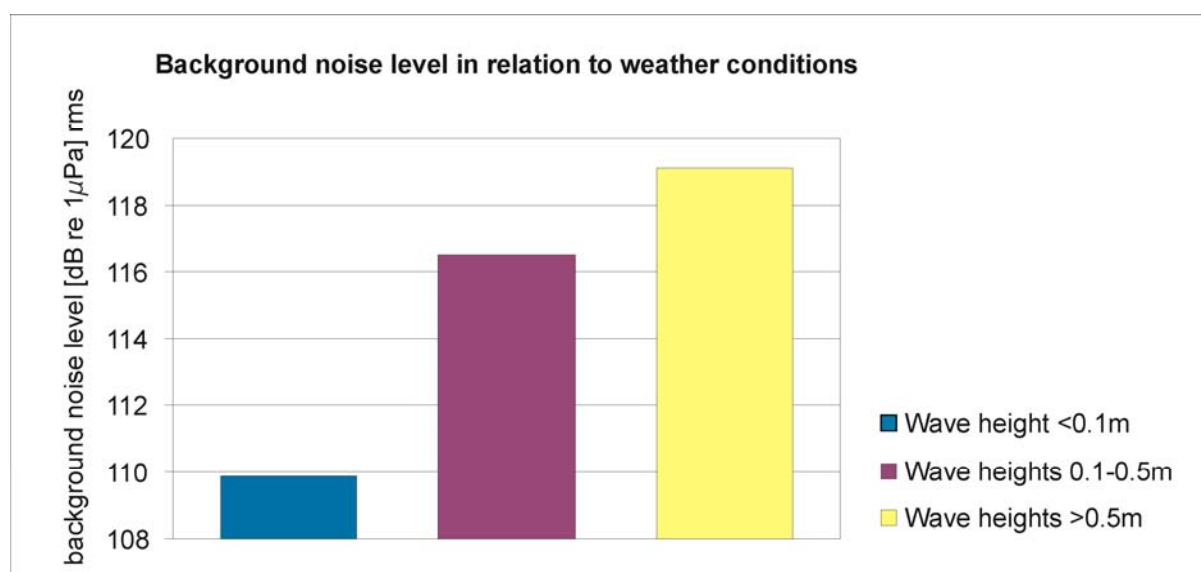

Figure 24: Average background noise at the mesocosm site measured at two different hydrophones at different sea states.

4.1.2 Sound field during playback

Transmission loss

The speaker proved to be reliable and the system was able to produce source pressure levels of about 170 dB re 1 μ Pa peak. As expected, sound transmission was dependent on the water depth which varied with the tides. Transmission loss was in general greater at loudspeaker position 2 compared to position 1 due to the greater water depths at position 2. Sound transmission loss in

shallow waters is highly variable and is influenced by a number of factors such as the acoustic properties of the bottom of the sea and the water surface (Parvulescu 1964). In theory cylindrical spreading (as opposed to spherical spreading in deep waters) is expected and transmission loss is calculated as $10 \log(R)$ where R is the distance from the sound source. But due to the strong variations in shallow water conditions, this formula is only a rough estimation and, if possible, transmission loss should rather be measured than calculated.

In the experiments the transmission loss over a maximum distance of 100 m was measured with four hydrophones. Figure 25 shows the sound pressure values measured at different distances from the sound source while playing back sound from either position 1 or 2. The red line shows the transmission loss that would be expected for cylindrical spreading in shallow waters ($10 \log(R)$) while the green line gives a higher transmission loss of $13 \log(R)$ and the blue line indicates a transmission loss of $15 \log(R)$. The measurements taken during sound production at position 1 were relatively close to the calculated transmission loss of $10 \log(R)$ while the measurements from play back at position 2 pointed to a higher transmission loss of 11 to $13 \log(R)$. The results also show that the sound fields varied with the constantly changing conditions at the field site. Therefore, the behavioural data should be related to the measured sound fields for each trial.

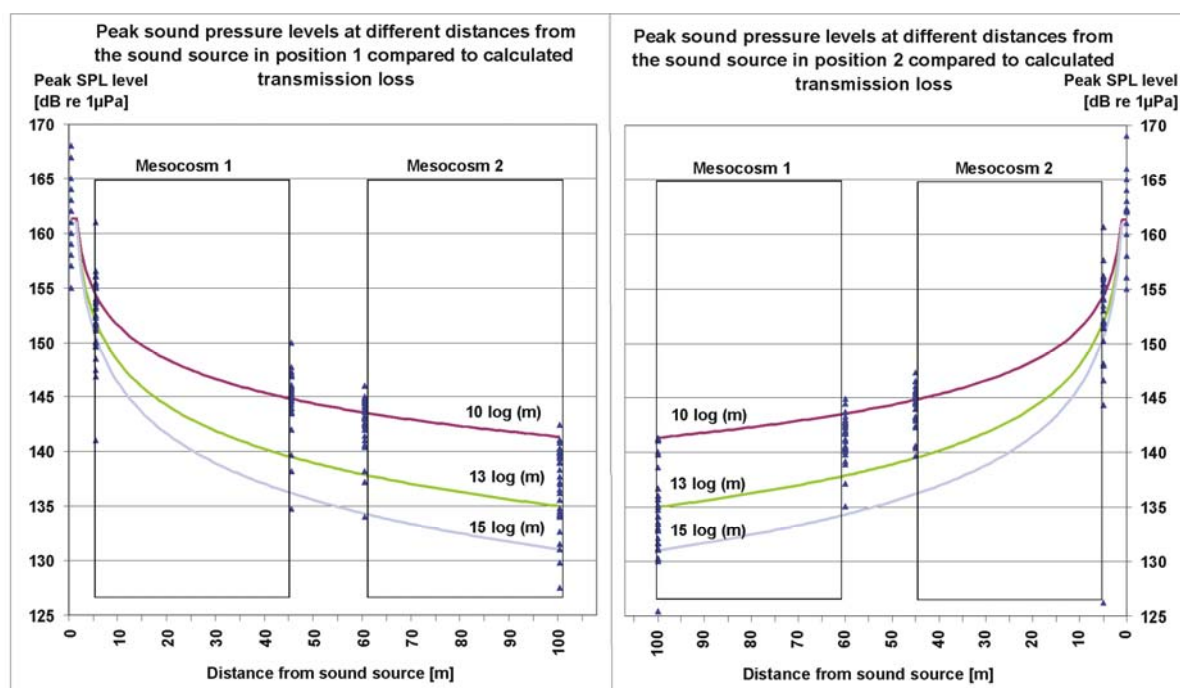

Figure 25: Peak sound pressure levels at different distances from the sound source compared to calculated transmission loss. (Left: Playback from position 1. Right: playback from position 2).

Sound pressure levels in the mesocosms

The playback protocol used three different playback levels differing by 6 dB (highest level, -6 dB, -12 dB). But due to changing tides, and therefore varying water depth, the received sound pressure levels measured at the hydrophones, and therefore experienced by the fish, didn't reflect the produced playback levels. Figure 26 shows the received sound pressure levels at 45 m distance from the sound source arranged in the three source sound pressure level groups but separated by loud-speaker position. It became obvious that the variations in each sound pressure level group were high and that the sound pressure ranges widely overlapped between groups. Figure 26 also shows that the received sound pressure levels were lower (higher transmission loss between sound source and hydrophone) in greater water depths. The concept of having three playback level producing compa-

orable sound fields on different sound levels was therefore abandoned for further evaluation of behavioural data.

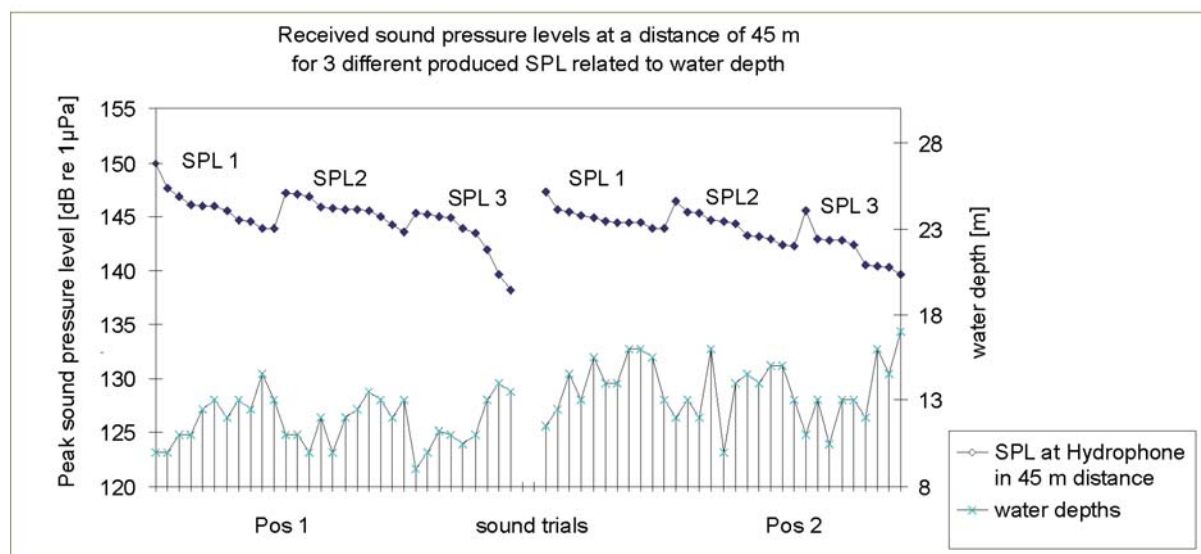

Figure 26: Received peak sound pressure levels in 45 m distance from the sound source. (Data arranged in three playback groups (highest, -6 dB, -12 dB) separately for the two loudspeaker positions).

To provide an impression of the sound fields, the average received sound pressure level at different distances was calculated. Received sound pressure levels were quite different in each mesocosm resembling mid to far ranges from a real pile-driving situation. Further, the fish were exposed to different sound fields by presenting playbacks at three different sound pressure levels. The sound pressure level was monitored simultaneously by hydrophones at distances of about 5, 45, 60 and 100 m from the loudspeaker. Figure 27 provides an overview of the average received sound pressure levels (dB re 1 µPa peak) measured at the four different hydrophones for the three different source levels of playback. The results clearly show higher sound levels in the near mesocosm than in the distant one.

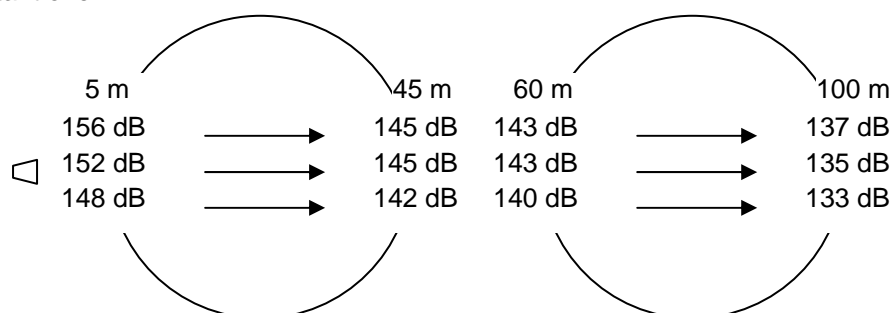

Figure 27: Average sound pressure level measured at four different hydrophones (Trapezoid marks loudspeaker).

Statistical evaluation of sound pressure levels in mesocosms and water depth

To test for the difference in sound fields between the two mesocosms and therefore test for the feasibility of the experimental design the received sound pressure levels were compared and statistically evaluated. Simultaneous measurements of received SPL showed that the mesocosm closest to the loudspeaker (near) was always subject to a higher SPL than the mesocosm more distant from the loudspeaker (far) (Figure 28). The median in the boxplots of Figure 28 were calculated from the minimum and maximum values measured. The higher difference in maximum values is caused by a quicker decrease of sound pressure close to a sound source. The minimum and maximum received SPLs were significantly different between the two mesocosms (Wilcoxon test,

$n = 51$, $p < 0.001$ for both variables). The mean difference between maximum SPL in the two mesocosms was 10.7 dB ($n = 51$, range 4 to 19.1 dB). The mean difference for minimum SPL was 8.29 dB ($n = 51$, range 2.6 to 17.5). Therefore, the experimental design ensured that the acoustic field always differed between near and far mesocosms, providing one important basis for the investigation of behavioural differences.

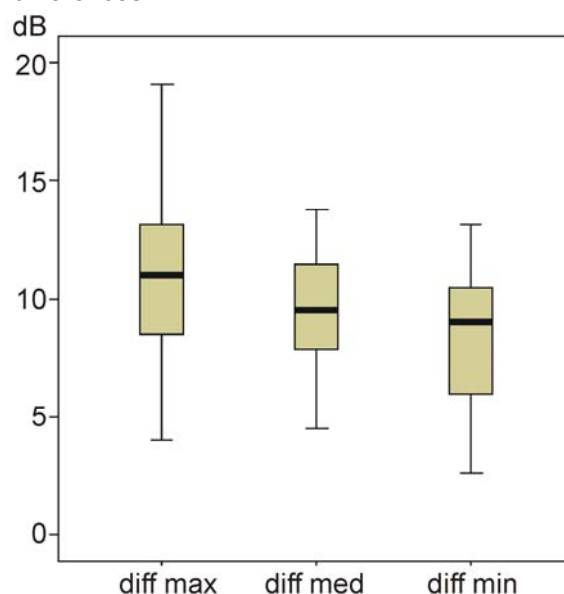

Figure 28: Difference between sound pressure levels in both mesocosms.

There was a significant effect of water depth on received SPL, with shallower water resulting in higher received SPL. However, the difference between near and far mesocosms in maximum and minimum SPL was not significantly correlated with water depth (maximum: $r_s = 0.201$, $p = 0.156$; minimum: $r_s = 0.217$, $p = 0.127$; Spearman rank correlation, $n=51$). Therefore, water depth was not considered further in investigations of behavioural effects.

4.1.3 Particle motion

Sound propagation

Measurements performed at different distances from the loudspeaker (6, 10, 15, 20, 25, 30, 60 and 110 m) showed that the relation between particle acceleration and distance, r , was described by $r^{-0.92}$ at the field site. This result is to be compared with cylindrical spreading ($r^{-0.5}$) and spherical spreading (r^{-1}). The transmission loss coefficient, $r^{-0.92}$, was used to calculate the amplitude of particle acceleration in the range between the sound source and 110 m when sound was played at location 2. The equation for transmission loss was:

$$\text{Sound Level}_{(r_2)} = \text{SL}_{(r_1)} / (r_1/r_2)^{-0.92}, \quad (\text{Eq. 1})$$

where SL is the source level, r_1 corresponds to 1 m and r_2 distance to the sound source.

Ambient noise

The observed levels of ambient noise at the field site showed a relative “quiet” sea in terms of particle acceleration (Table 5). After applying a 10 Hz-high-pass filter an average amplitude was found to be $8.6 \times 10^{-5} \text{ m/s}^2$ (rms), (SD 7×10^{-5}) for the frequency interval of 10 - 300 Hz using data from all measurements. Pronounced variations in the lower frequency region ($< 70 \text{ Hz}$) were observed at different days, most probably due to different sea states (Figure 29). It can on good grounds be assumed that the wave induced noise as well as noise from the mesocosm structure is found in the lower in frequency spectra. But since most of the energy in the piling pulse is in a frequency range of

up to 300 Hz (Figure 17) the change in ambient noise in the lower frequency interval is not expected to influence the fish reception of induced noise to any large extent.

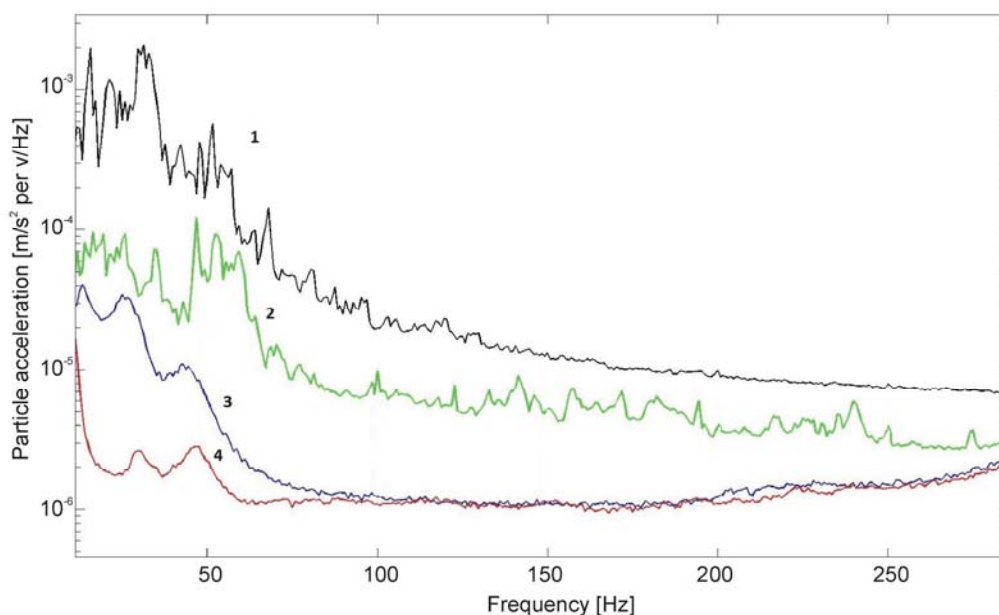

Figure 29: Spectrogram of ambient noise (particle motion) in the sea and the holding tanks: line 1: sole tank, line 2: cod tank, line 3: field site, waves 0.3m, line 4 – field site, waves 0.1 - 0.2m.

Particle motion during trials

Three different sound levels of piling noise (highest, -6 dB and -12 dB) were used during the trials. These differences were not observed in the measured amplitudes of particle acceleration (Kruskal-Wallis ANOVA $n=13$, $\chi^2=2.59$, $p=0.27$). The amplitudes of particle acceleration, recalculated to SL using equation 1, were found to vary between the trials even when the same playback level was used (Table 5). The same effect was observed for sound pressure levels related to variations in sea-level heights, mainly due to the local tide, as described earlier in section 4.1.2. There was no statistical depth dependence found for particle acceleration (Pearson correlation, $p=0.20$), possibly due to a small sample size.

Table 5: Peak particle acceleration during trials, presented as source level (SL 1 m) using calculations of transmission loss as described in the section on sound propagation.

Trial no.	Distance to sensor	Water depth	SL _(1m) (m/s ²) at peak	Ambient (m/s ²) rms
1	6	13	3.1×10^{-2}	3.4×10^{-5}
3	6	12	1.5×10^{-2}	2.7×10^{-5}
8	5	12.5	4.0×10^{-2}	1.6×10^{-4}
10	5	11	3.3×10^{-2}	8.6×10^{-5}
12	4	10.5	3.5×10^{-2}	1.0×10^{-5}
20	7	15	3.1×10^{-2}	2.5×10^{-5}
22	7	10	1.7×10^{-2}	3.6×10^{-5}
24	10	9.5	2.1×10^{-2}	3.4×10^{-5}
25	5	10	4.3×10^{-2}	3.6×10^{-5}
32	5	10	2.3×10^{-2}	4.0×10^{-5}
34	6	10	3.1×10^{-2}	3.5×10^{-4}
36	6	10	2.1×10^{-2}	9.1×10^{-5}
44	6	11	3.7×10^{-2}	8.8×10^{-5}

Ambient levels in the table are given as rms-amplitude, recorded some minutes before playbacks were initiated. Distance to sensor: actual distance between sensor and loudspeaker during each trial, water depth is given relative to the sea floor; sensor depth was 0.9 m above the sea floor.

As previously mentioned, different levels of particle acceleration were recorded during the first set of cod experiments with the sensor being stationary in one position. For an estimation of particle acceleration amplitudes within the mesocosms, an average peak SL particle acceleration of $SL_{(1m)} 2.9 \times 10^{-2} \text{ m/s}^2$ peak was calculated from measured amplitudes (Table 5) with a standard deviation of $SD 9 \times 10^{-3}$. This value was thereafter used with equation 1 to estimate particle acceleration amplitudes within the mesocosms (Figure 30). The results show a sharp gradient in particle acceleration within the near mesocosm (from 6.5×10^{-3} to $8.6 \times 10^{-4} \text{ m/s}^2$ peak) with a more moderate decline within the far mesocosm (from 6.6×10^{-4} to $4.1 \times 10^{-4} \text{ m/s}^2$ peak). This is attributed to the exponential behaviour of particle acceleration as a function of distance.

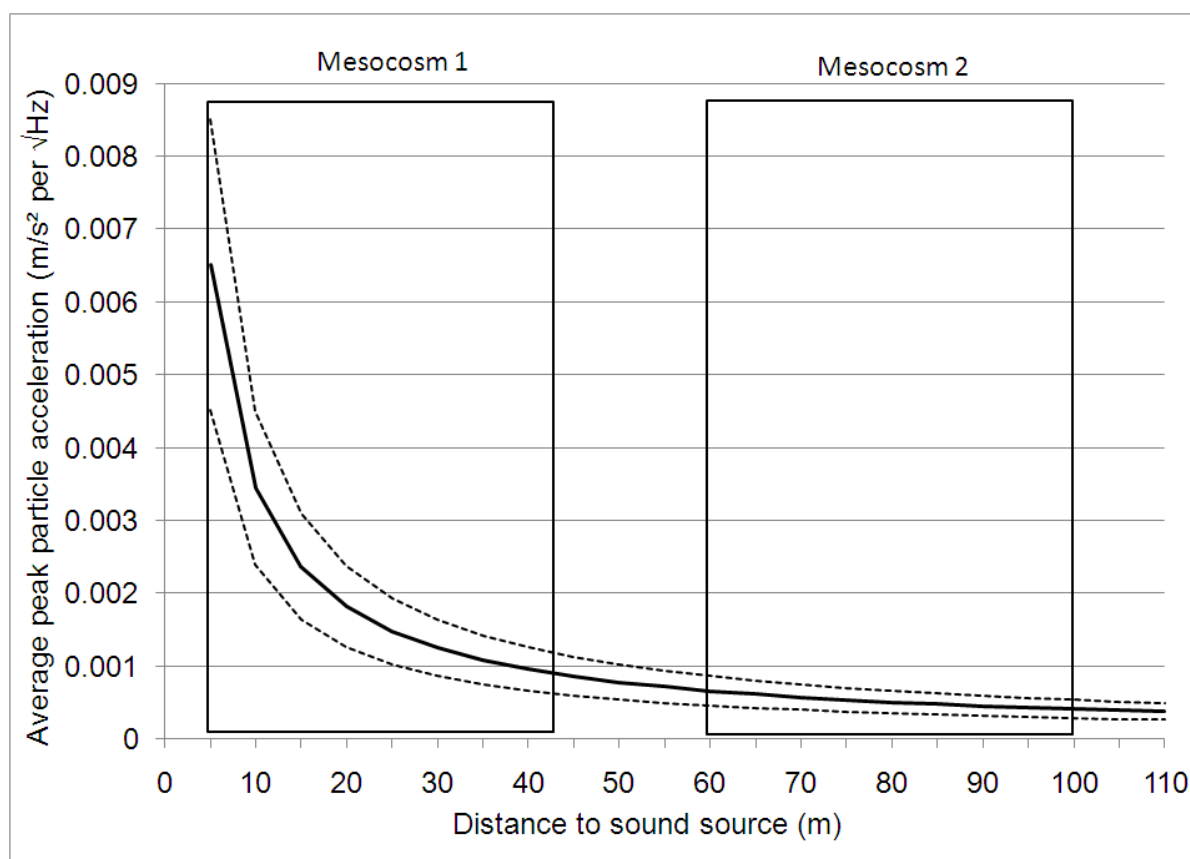

Figure 30: Propagation of particle acceleration at the field site. (Black line: Average, dotted line: standard deviation).

Our conclusion is that even though measurements of particle acceleration were only performed during the first set of cod experiments, the amplitudes (including standard deviation) presented in Figure 30 will be representative for the other two sets of experiments (sole and cod group 2).

Caution has to be taken when comparing a continuous sound of ambient noise with the transient piling pulse. Nevertheless, in an attempt to compare the particle accelerations that the fish were exposed to before, during and after trials, a recorded piling pulse (5 m from loudspeaker, 10 m water depth) of 0.1 second (equivalent to roughly 90 % of the energy in a piling pulse) was cut out from trial 25 (for peak SL see Table 5). The pulse was plotted in a spectrogram together with ambient noise at the field site and from the 5 m cod tank, using the same sample length (0.1 second) (Figure 31). The generated piling pulse was well above both ambient noises in the sea and in holding tank throughout

the spectrum. As a result, the fish was exposed to almost 100 times higher particle acceleration from the loudspeaker than before experiments, both in the tanks and in the sea.

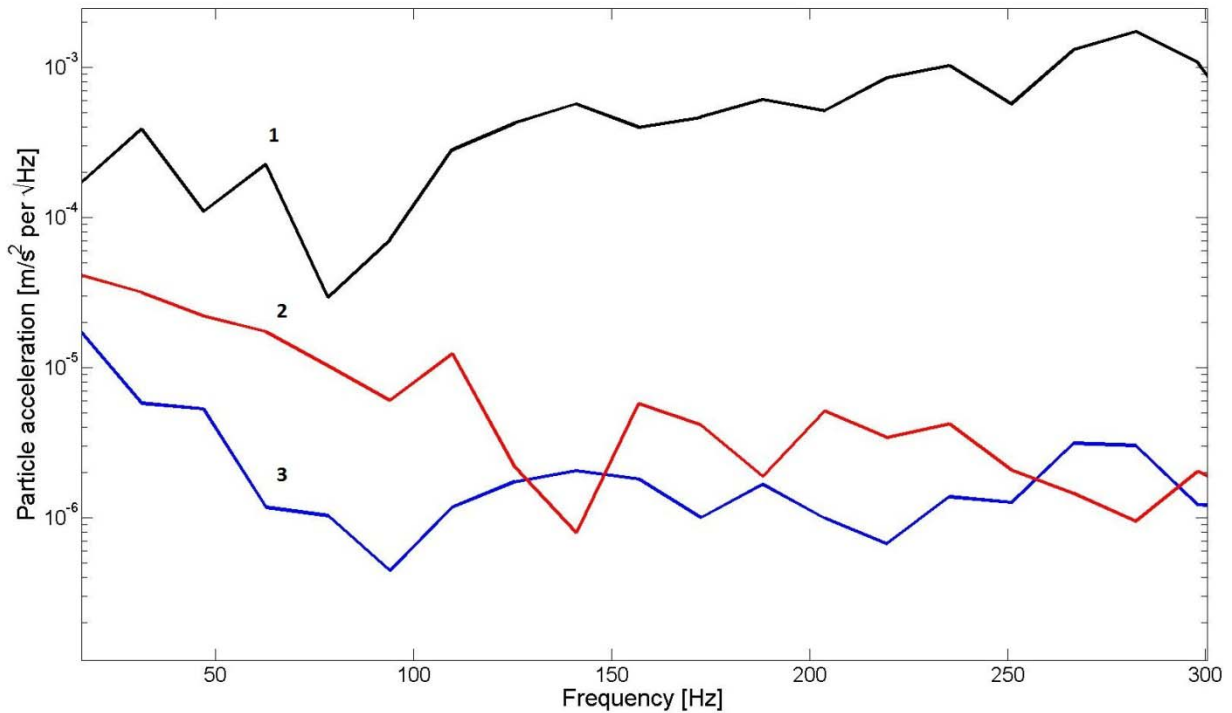

Figure 31: Spectrogram of 0.1 seconds of a recorded piling pulse (1), noise in the 5 m cod tank (2), ambient noise (3).

4.1.4 Current meter data

The current meter collected eight readings per hour continuously from the 25th July to the 22nd September. As expected for the location the current speed was low with an average of 3.1 cm/s and a maximum reading of 17 cm/s. The average temperature was 13.4°C with a maximum of 14°C. For evaluation the data of 12 daylight hours of each experimental day were separated and plotted. Two examples are given in Figure 32 with very similar tidal conditions but rougher weather conditions on the 26th of July. A data summary of the experimental days is given in Appendix Table 1.

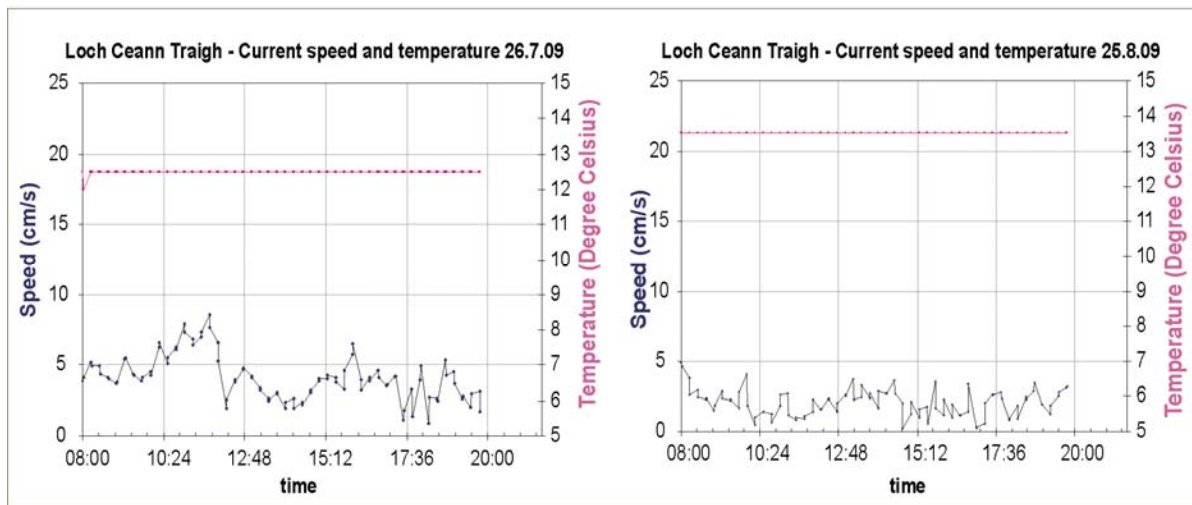

Figure 32: Two examples for current meter data.

4.2 Behavioural experiments

During July to September 2009 a total of 62 experiments were undertaken on 50 fish at the Ardtoe field site. Positional data was gathered from 30 cod in 34 experiments and from 20 sole in 26 experiments. Overall 4,114 positional data points were collected (2,091 for cod and 2,023 for sole). An overview on the experimental trials is given in Table 6.

Table 6: Overview of experimental trials.

Fish / Date	No. of trials	No. of fish	Collected data points
Cod			
24.7.09	6	7	334
26.7.09	6	8	476
1.8.09	3	(5)	197
3.8.09	2	(7)	150
5.8.09	6	7	474
14.9.09	6	5	229
18.9.09	5	3	231
Summary cod	34	30*	2,091
Sole			
19.8.09	6	5	530
21.8.09	6	6	497
23.8.09	4	6	262
25.8.09	4	3	332
27.8.09	6	(6)	402
Summary sole	26	20*	2,023
Overall summary	60	50*	4,114

*due to repetition of experiments some fish were observed twice on different days. These fish (numbers are in brackets) were only counted once in the summary and don't add to the final sum of individual fish.

4.2.1 Overview of behavioural response

Initially, movements of individual fish during a period of 30 minutes (10 minutes before, 10 minutes during and 10 minutes after sound playback presentation) were visually interpreted and sorted in three behavioural response categories to playback groups (stationary, movement throughout, spatial response, defined in chapter 3.13). Two examples of a clear spatial response to sound in sole (Figure 33A) and cod (Figure 33B) are given below. Before playback the individuals showed a relatively constrained spatial distribution (red dots), however, during pile-driving noise playback (green dots) the fishes showed a larger spatial response in distribution. After playback movement (black dots) was constrained to a small area again. The arrows inside the circle indicate the overall direction of movement; the black circles outline the perimeter of the mesocosms. The sole experiment was carried out during incoming tide, water depth of 13 m, light to moderate wind; wave height of 0.05-0.1m. Sound pressure in the mesocosm was 146 - 152 dB re 1 μ Pa; particle acceleration: 6.5 x10³ - 8.6 x10⁻⁴ m/s² peaks. For cod the environmental conditions were outgoing tide, water depth of 11 m, light rain, wind estimated 3-4 ms⁻¹, and waves estimated 0.1 m. Received average sound pressure levels were between 133-143 dB re 1 μ Pa (see Figure 27), particle acceleration: 6.6 x10⁻⁴ - 4.1 x10⁻⁴ m/s² peak.

Kernel probability density function surfaces were plotted for the two examples given in Figure 33 in order to estimate the extent of spatial range before during and after pile-driving noise playback. These plots can be found in the Appendix, Figure 1 to 6. The results clearly highlight stark differences in the use of individual spatial range within 95%, 70% and 50% volume estimates during pile-driving noise playback compared to that observed before and after sound playback.

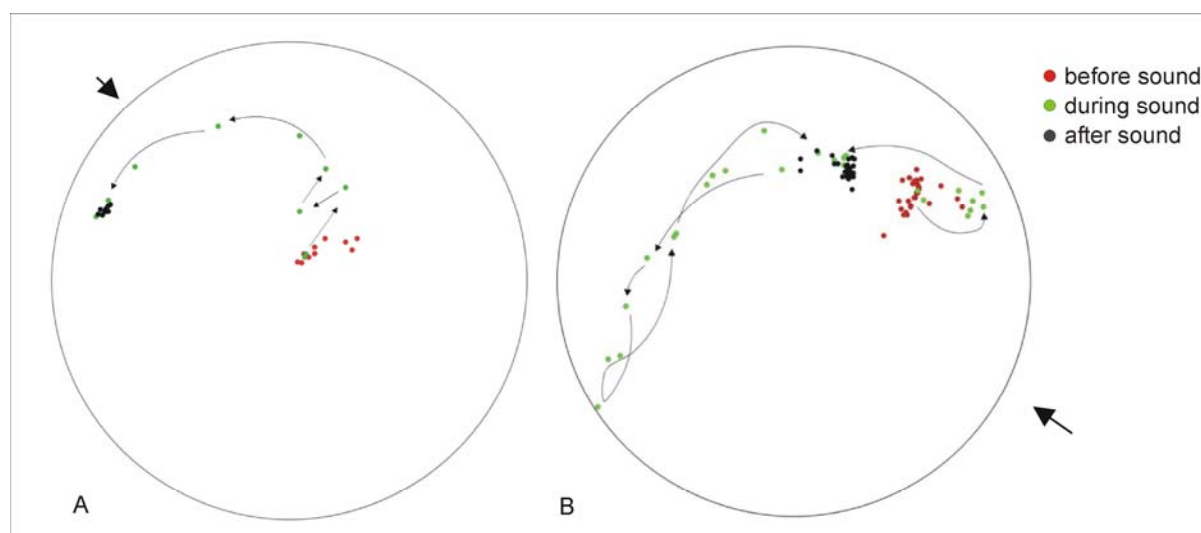

Figure 33: Example output from the VRAP software showing sequential position fixes of a sole (A) and cod (B) in relation to one sound trial (Red dots: movement before sound playback, (green dots: movement during sound playback, black dots: movements after sound playback). The arrows outside the circles indicate the direction of the sound source).

Overall almost half (45%) of the cod and 32% of the sole showed a movement or spatial response to playbacks of pile-driving noise. Figure 34 shows the number of individual observations for cod and sole in the close and distant mesocosm for both fish species. An interesting result was that more fish remained stationary in the mesocosm closest to the sound source, experiencing the highest sound levels (Figure 27), than in the distant one. This was further evaluated by calculating the swimming speed of individual fish (see chapter 4.2.2 on swimming speed). Definition see chapter 3.13.

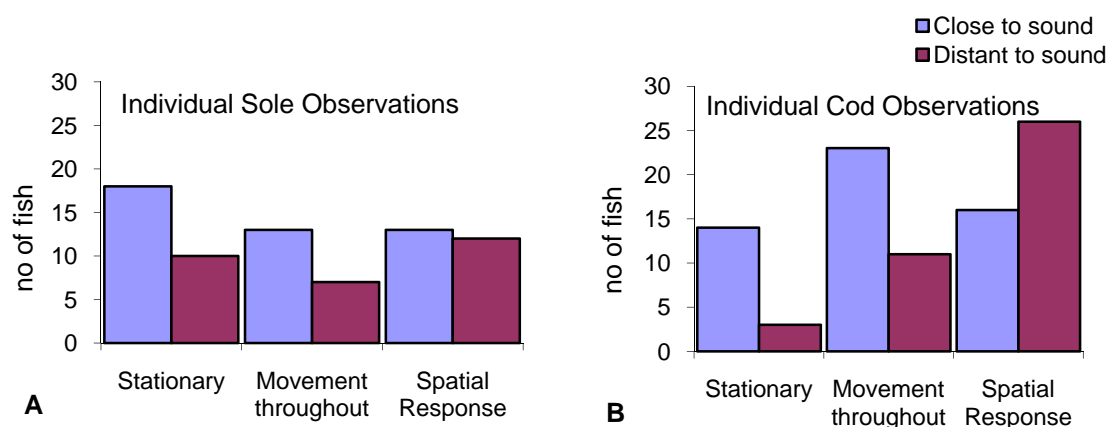

Figure 34: Number of individual movement observations A: sole and B: cod grouped by behaviour type (stationary, movement throughout or spatial response to sound), and split by appropriate mesocosm.

4.2.2 Swimming speed

The swimming speed of different exposure groups was calculated and compared for the periods before, during and after sound. The group of sole exposed to sound for the first time did not show a significant behavioural pattern, but a significant pattern was apparent in the group exposed to sound 2 - 5 times (Figure 35). In the mesocosm closest to the sound source, the swimming speed increased significantly during playback (Wilcoxon matched pairs signed ranks test, $z = -2.166$, $n = 14$, $p=0.03$). The same comparison for subjects in the far mesocosm was not significant (Wilcoxon matched pairs

signed ranks test, $z = -0.7$, $n = 8$, $p=0.484$). In the third group of fish exposed to 27 - 28 playback experiments, swimming speed tended to be higher in the far mesocosm but the small sample size (three fish) precluded statistical testing. All swimming speed figures for sole can be found in Appendix Figure 7.

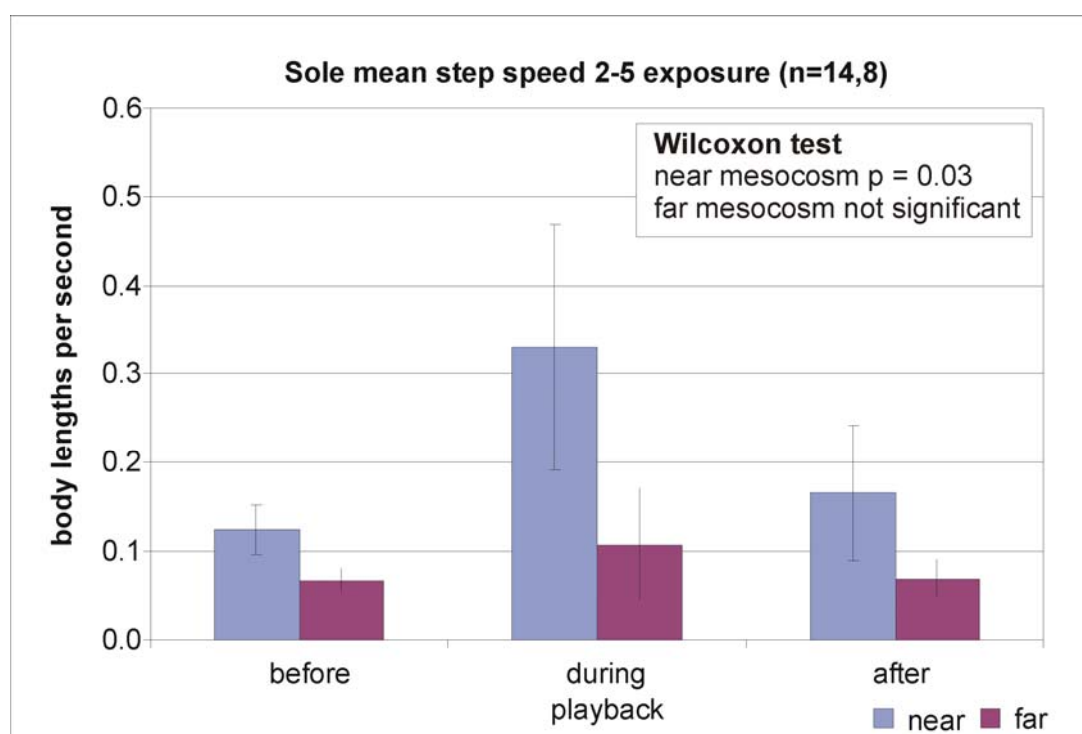

Figure 35: Mean step speed within the periods of trial for sole that experienced sound for 2 to 5 times. (Sound pressure levels in the near mesocosm were between 144 and 156 dB re 1 μ Pa and particle acceleration 6.5×10^{-3} and 8.6×10^{-4} m/s² peak).

During playback the fish tended to be speeding up compared with the single step at the moment when the loudspeaker was switched on. This was more marked in the near mesocosm. In both mesocosms, swimming speed fell from the playback period to the single step when the loudspeaker was switched off (Appendix Figure 8). Neither pattern was statistically significant.

As in sole, the cod in the near mesocosm tended to have higher swimming speeds during playback. The pattern was most pronounced in the group of fish exposed to 3 - 5 playback trials. There was no clear pattern in the far mesocosm (Figure 36). A two-way ANOVA, with mesocosm and period as factors on data from fish exposed to 3 - 5 playback trials, supports this interpretation because while neither factor was significant, the interaction approached significance ($F_{3,1 \text{ df}} = 3.46$, $P=0.071$). The complete results of swimming speed in cod can be found in Appendix Figure 9.

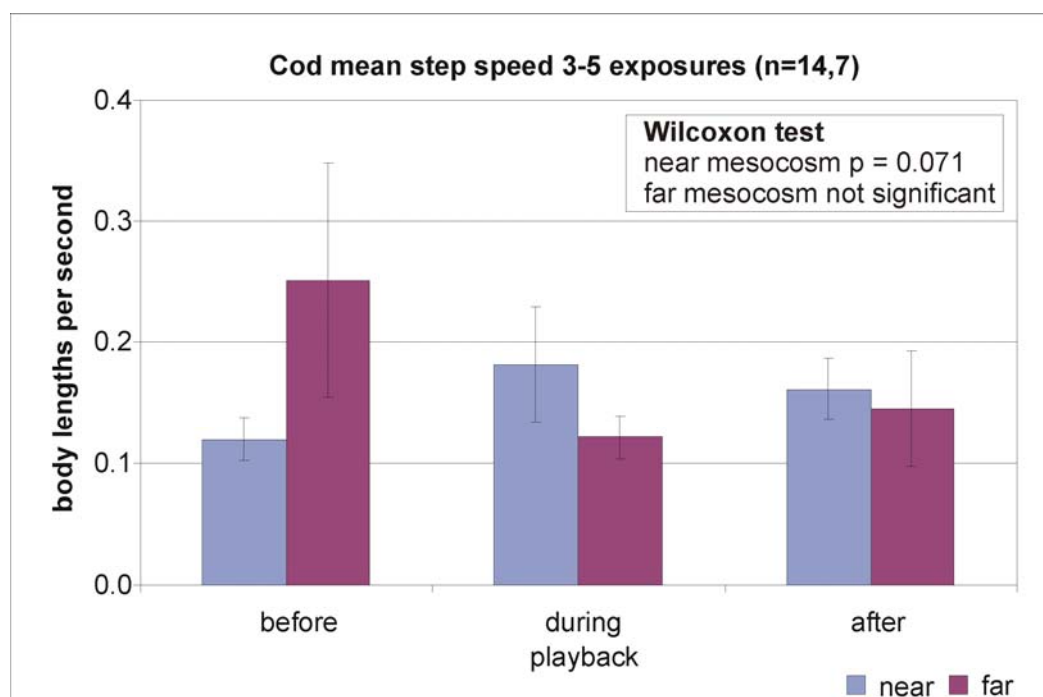

Figure 36: Mean step speed within the periods of trial for cod that experienced sound for 3 to 5 times. (Sound pressure levels in the near mesocosm 140 to 161 dB re $1\mu\text{Pa}$, particle acceleration 6.5×10^{-3} to 8.6×10^{-4} m/s^2 peak).

Freezing response in cod

By comparing the average swimming speed of cod in the periods before, during and after sound with the swimming speed of the step at the moment when the loudspeaker was switched on or off, a more obvious pattern appears (Figure 37). In the mesocosm close to the loudspeaker the speed dropped the moment the loudspeaker was switched on. After this apparent initial freezing reaction the swimming speed increased and dropped again as soon as the sound was switched off. Afterwards the swimming speed remained the same.

Figure 37 shows the four changes: Before to BtoA (BtoTrans), BtoA to During (TranstD), During to DtoA (DtoTrans2), and DtoA to After (Trans2toA). While Before, During and After are average swimming speeds of 10 minute periods the Transition values give the step speed between the last position of one period and the first position of the next period. The difference between the four change periods differed significantly (non-parametric repeated measures 1-way ANOVA; $H = 13.98$, $df = 3$, $P = 0.0029$). Sound pressure levels in near mesocosm were 140 to 161 dB re $1\mu\text{Pa}$, particle acceleration 6.5×10^{-3} to 8.6×10^{-4} m/s^2 peak. Far mesocosm sound pressure levels 133 to 146 dB re $1\mu\text{Pa}$, particle acceleration 6.6×10^{-4} to 4.1×10^{-4} m/s^2 peak.

An analysis of covariance (ANCOVA) was used to establish whether exposure to playback affected response. In the near mesocosm, there was a significant effect of exposure ($F_{3,103df} = 3.17$, $P = 0.027$) and the corrected model closely approached significance ($F_{4,103df} = 2.393$, $P = 0.055$), i.e. it supports the repeated measures one-way AOV (even though the ANCOVA is not a repeated measures design). This suggests that, on this measure, exposure to playback contributes to individual differences between subjects in response to playback.

In the far mesocosm there was no significant effect of the four change periods on swimming speed (non-parametric repeated measures one-way AOV; $H = 2.37$, $df = 3$, $P = 0.499$) and the ANCOVA found no significant effect of exposure ($F_{3,103df} = 3.17$, $P = 0.693$).

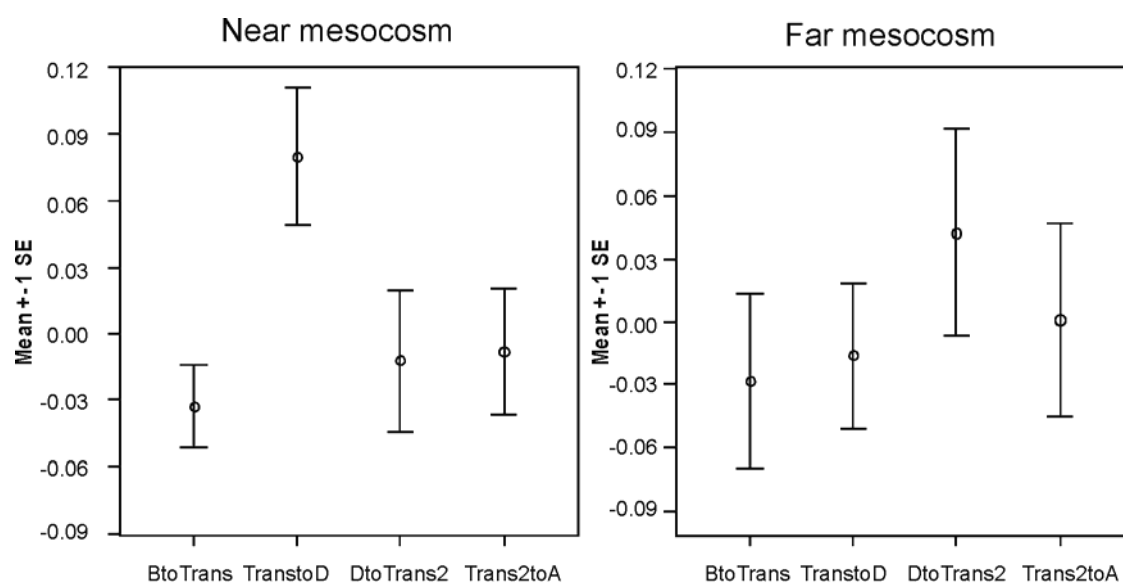

Figure 37: Change in step speed between the variables (Before, BtoD, During, DtoA and After. Explanations see text above).

Response of individual fish

To further investigate in the variability of the reactions and for an in depth analysis of the differences between speeding up and freezing behaviour, the swimming speed of sole and cod was evaluated on an individual basis and the average swimming speed in the three 10 minute periods before, during and after sound presentation were calculated. A reaction was defined as at least a doubling or halving of swimming speed between the periods.

In sole a doubling of speed during sound playback was observed in 24% of the fish, in 13% the speed increased after the sound was switched off. In 11% of observations the fish slowed down drastically during sound presentation which was interpreted as a freezing response (see text in chapter 4.2.1 on spatial distribution). The freezing response in sole was mostly observed in the near mesocosm (six of eight observations). Overall, 48% of sole showed strong changes in swimming speed related to the periods with and without sound playback. Individual reactions appeared over a range of 138 to 156 dB re 1 μ Pa maximum sound pressure level in a mesocosm (particle motion between 6.51×10^{-3} and 4.13×10^{-4} m/s² peak). This includes reactions in the far mesocosm which weren't overall significant and therefore the sound pressure level range is wider than in the statistical evaluation.

In cod 24% of the fish at least doubled their speed, 15% moved much slower during playback (interpreted as a freezing response) and 9% increased their swimming speed after the sound was switched off. Overall, 48% of cod reacted to the sound by changing their swimming speed drastically. Three examples of different behaviour are given in Figure 38 showing that a mixture of individual reactions strongly influences the results of the mean step speed evaluation. This result emphasizes the importance of repeated measures statistical analysis and this contributed to the significant or close to significant reactions found in the near mesocosm even with 11% of sole and 15% of cod showing a freezing reaction. Individual responses in cod were observed at the full sound pressure range (maximum values in each mesocosm) from 135 to 161 dB re 1 μ Pa. This includes reactions in the far mesocosm which weren't overall significant and therefore the sound pressure level range is wider than in the statistical evaluation.

By ranking the rate of movement (in body length s⁻¹) for each individual fish by trial for each 10 minute period (greatest rate of movement compared to least) and comparing the ranking using Chi-

squared analysis (by species and observation period) the individual swimming speed was evaluated. Taking this approach showed that rate of movement was significantly less “before” playbacks compared to “during” and “after” for both cod and sole (Chi-squared values of 10.31, $p < 0.01$ for sole with 2 degrees of freedom and 9.59, $p < 0.01$ for cod with 2 degrees of freedom). A greater rate of movement was also found overall “during” or “after” playback when compared with “before” for both cod and sole (Chi-squared values of 7.82, $p < 0.05$ for sole with 2 degrees of freedom and 9.05, $p < 0.05$ for cod with 2 degrees of freedom). Finally the greatest rate of movement in sole was found “after” playback (chi-squared value of 8.91, $p < 0.05$ for sole with 2 degrees of freedom).

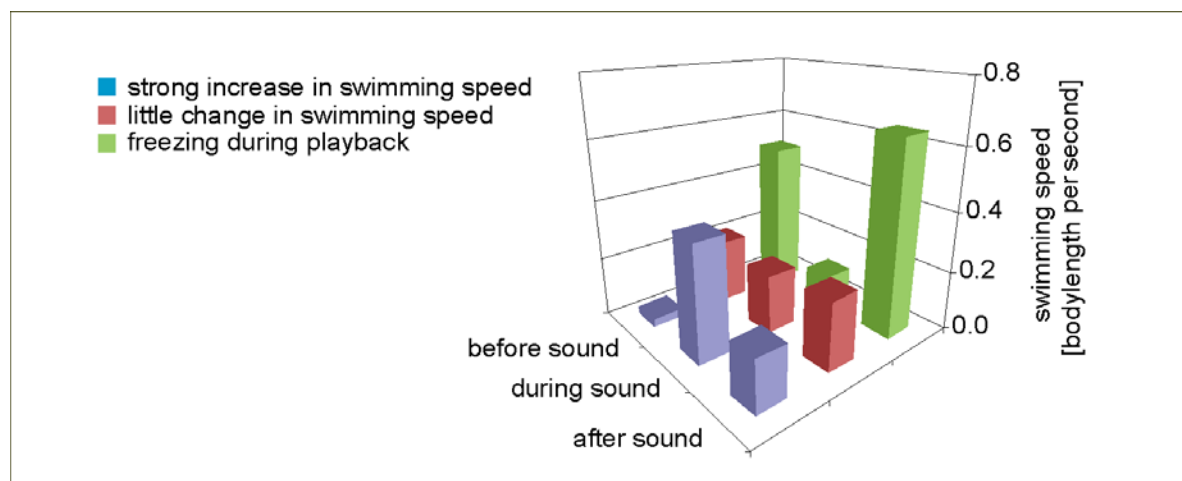

Figure 38: Examples for individual reactions of different cod to sound.

4.2.3 Directional movement

Sole changed their swimming direction in the near mesocosm when the sound was first presented (Figure 39). While the average movement before sound was towards 6.9° (loudspeaker located at 0°) the average swimming direction changed to 250° immediately after the sound was switched on. In later experiments (2 - 5 exposures), in the near mesocosm, the swimming direction remained the same before and after switching the sound on. After considerable exposure (27-28 playbacks) there was even movement towards the sound source but this was based on only 3 individuals. The complete figures can be found in the Appendix, Appendix Figure 10, Appendix Figure 13. In the far mesocosm a directional reaction in sole could not be observed.

In cod there also appeared to be movement away from the sound source when the sound was presented for the first time in the near mesocosm (Figure 40) with three of the five cod moving directly away from the loudspeaker. A reaction was also observed in the far mesocosm - when cod were exposed to 3 - 5 playbacks (Figure 41), they changed their average swimming direction from 5° to 131° .

Last direction before sound

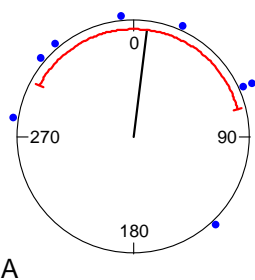

First direction during sound

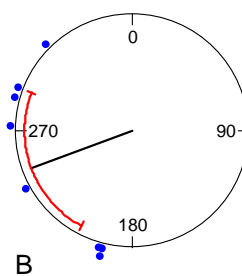
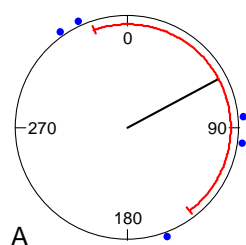

Figure 39: Directional response of sole to the 1st playback in the near mesocosm (8 individuals). Loudspeaker at 0°, sound pressure levels 144 to 156 dB re 1µPa, particle acceleration 6.5×10^{-3} to 8.6×10^{-4} m/s² peak.

Last direction before sound



First direction during sound

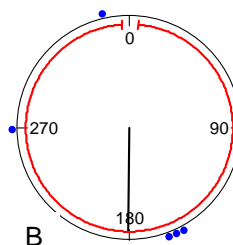
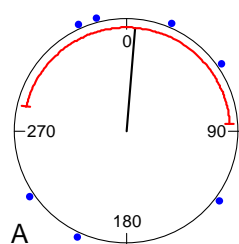

Figure 40: Directional response of cod to 1st playback in the near mesocosm (5 individuals). Loudspeaker at 0°, sound pressure levels 146 to 155 dB re 1µPa, particle acceleration 6.5×10^{-3} to 8.6×10^{-4} m/s² peak.

Last direction before sound



First direction during sound

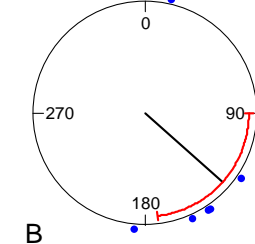

Figure 41: Directional response of cod to 3-5 playbacks in the far mesocosm (7 individuals). Loudspeaker at 0°, sound pressure levels 133 to 145 dB re 1µPa, particle acceleration 6.6×10^{-4} to 4.1×10^{-4} m/s² peak.

4.2.4 Response thresholds

The results show that the sound pressure levels used in the present experiments were high enough to cause significant reactions in cod and sole. Significant changes in swimming speed and changes in swimming direction in sole were observed when the fish were exposed to sound between 144 and 156 dB re 1 μ Pa and particle accelerations levels between 6.51×10^{-3} and 8.62×10^{-4} m/s² peak. Some individual reactions appeared at even lower levels.

Cod reactions in average swimming speed and an initial freezing response were observed in a sound pressure range from 140 to 161 dB re 1 μ Pa (particle motion 6.51×10^{-3} to 8.62×10^{-4} m/s² peak). But some changes in swimming direction in the far mesocosm and some individual reactions at lower sound levels indicate that the threshold for behavioural reactions for some fish might be lower than this range of values.

4.2.5 Habituation

In the overall swimming speed evaluation, sole showed significantly higher swimming speed during playback when exposed to 2 - 5 sound trials. This effect was not observed when exposed to the 27th or 28th playback. In cod the increase in swimming speed was less when exposed to 14 - 19 playbacks compared with exposure to 3 - 6 experiments. A directional response was observed in sole and cod in the near mesocosm when exposed to the sound for the first time. In later exposures a clear directional response away from the sound source was not observed but sole seemed to move into the direction of the sound source during exposure to 27 or 28 playbacks. On an individual basis, a habituation effect in relation to swimming speed with increasing exposures could not be observed.

5 Discussion

We believe that our study provides important insights into the behavioural response of marine fish to pile-driving sound. Both sole and cod showed obvious and, in some cases, significant behavioural responses to pile-driving sound in a coastal environment. Responses were more pronounced in, but not restricted to, the near mesocosm where fish were exposed to higher sound pressure levels. Nearly half of the cod and one third of the sole showed spatial responses to the sound, 48% of the individual fish in both species doubled or halved their swimming speed in relation to the playbacks. Overall in sole a significant increase of swimming speed was observed while in cod the data strongly suggest an increase in swimming speed.

To summarise three clearly different types of reactions by the fish were observed:

- fish increased their overall speed in the 10 min sound exposure period,
- fish slowed down at onset of playback, indicating a freezing response and
- fish sped up after the playback was switched off which was sometimes combined with a freezing reaction during sound.

Additionally directional response away from the sound source was observed in both species when sound was presented for the first time. Statistically significant behavioural responses occurred in cod between 140 and 161 dB re 1 μ Pa peak and in sole between 144 to 156 dB re 1 μ Pa peak (particle motion 6.51 x10⁻³ and 8.62 x10⁻⁴ m/s² peak). In the following sections we discuss the experimental approach and setup, the hydro acoustic data and the behavioural results. We also elaborate on the implications of the results for the environmental management of pile-driving and suggest future studies.

5.1 Did our experimental setup work?

As the results indicate, the setup for controlled behavioural playback experiments worked very well. Most notably, a significant sound pressure difference between the mesocosms close to and distant from the sound source was found, thereby exposing the fish to different sound fields along a gradient. We were also able to clearly simulate a pile-driving signal at a sound pressure resembling relatively large distances from a pile driver. A novelty was the inclusion of particle motion measurements which are of great importance especially to judge the effect of sound on species such as sole that are only sensitive to particle motion (Popper *et al.* 2003).

The extensive scale of the mesocosms and their position within the coastal environment were important for the applicability of the study results to offshore wind farm environment. However with this scale of operation, there was a large amount of maintenance involved in ensuring the set up was suitable for the acoustic studies. This involved extensive cleaning of the mesocosms and re-setting and adding moorings to restructure the underwater pens which caused some delays to the field experiment schedule and provided an ongoing challenge to the team. The majority of marine fouling was removed by cleaning of the mesocosms and our results indicate that any remaining fouling on the net structure did not affect the sound transport through the mesocosm, since the transmission loss that did occur was within the range that could be expected for shallow water conditions (Urick 1983). The base of the mesocosms are in contact with the seabed and whilst the design does work at containing the fish there were some escapees that used the holes dug out by brown crabs getting under the nets. The unpredictable weather conditions also added to the field work challenge and created delays.

The sophisticated experimental plan with four groups of fish that were introduced consecutively into the mesocosms allowed investigation of the reaction of all subjects to the first playback (i.e. the response of naïve fish). A constraint of the VRAP location system meant that each fish tag had to be set to transmit signals at predetermined times. Therefore difficult weather conditions had a significant

influence on the experimental schedule. Sample sizes could be improved with a new generation of fish tags that are able to collect and store data for longer time series and therefore further experiments might allow more flexibility (see www.cefastechnology.co.uk for a description of movement tags).

Owing to the time of the year, the resources available and the short timescale that the project operated within, we were unable to get sufficient numbers of wild-caught cod of an adequate size for the experiments. We therefore used farmed cod as an alternative. There were important advantages in that there was easy access to the fish that were held at the Viking Fish Farms Ltd, Ardtoe Marine Laboratory and the short transport distance to the mesocosm site. Therefore the fish test subjects would have had low stress which can be an important influence on behavioural response of an organism. The fish came from the same stock, had the same life history and known acoustic history. It is unlikely that the farmed cod used in our experiments was less sensitive to sound due to prior noise exposure in the tanks. As our measurements indicate, the ambient noise in the tank in which cod lived most of their life prior to the experiments was relatively low and similar to the ambient noise levels in the mesocosms under most circumstances. In line with this, the cod in the experiments showed clear reactions to the sound and we are therefore confident that we can extrapolate our conclusions to wild stocks. However, the results on wild sole showed clear reactions, even though this species is considered to have relatively poor sensitivity to sound. It is possible that wild cod would show even stronger reactions as those found in this study. We therefore recommend following up experiments with wild-caught cod.

The experimental design didn't allow an investigation into sediment transport that might be of importance for flatfish such as sole (Hawkins pers. comm. 2009). The importance of sediment transport has yet to be assessed, but it is likely to affect only bottom dwelling fish in a restricted area around the pile-driving activity.

5.2 Hydroacoustics

The gradient in sound pressure level between the two mesocosms was a key feature for the success of the playback experiments. The mean difference between the highest values in the two mesocosms was close to 11 dB. Considering that an increase of 6 dB equals a doubling of sound energy an increase of 12 dB would expose the fish to eight times higher sound energy in the near mesocosm compared to the distant one. The presented playbacks sound levels were relatively low and similar to received sound pressure levels at several km distance from the source (OSPAR 2009, Thomsen *et al.* 2006). We see this as an advantage of our design as fish might allocate their behavioural response due to a gradient from relatively high to lower received sound pressure levels and not in reaction to a loud source that provides little alternatives for moving from very loud exposures into quieter zones. Our simulation of pressure experienced at distance is also more relevant when investigating long range avoidance and hence potential population level consequences of exposure to pile-driving sound.

Measurements of particle motion during pile-driving are so far not available. While our study provides the first insights into particle movements during playback of pile-driving sound we have to note here that – in contrast to pressure - particle motion caused by 'real' pile-driving might be quite different from the particle motion produced by a loudspeaker. Particle motion decreases more rapidly with distance from the sound source than sound pressure and it is therefore not clear how far particle motion can be perceived (Bass & Clark 2003). In our experiments a steep decrease in particle motion over the first 30 m was observed (Figure 30) with much slower decrease afterwards so the ability to detect particle motion is likely to be restricted to a relatively small area around a sound source even under natural conditions. Hawkins (2009) speculates that during pile-driving particle motion is transported through the sediment and might then emerge into the water column again at a greater distance from the sound source. If true, this would result in particle motion peaks appearing at

greater distances from the source of pile-driving activity. Measurements of particle motion during pile-driving are urgently needed to test this hypothesis.

As expected, a clear relationship between measured sound pressure and particle motion levels could not be determined in the experiments due to the complicated conditions in the acoustic near-field existing in shallow waters (Parvulescu 1964). Therefore the particle motion measurements were of great importance to determine the acoustic field the fish were exposed to, since they cannot be estimated or calculated from SPL values when close to a sound source and when reflecting boundaries like the sea bed and the water surface are close. Since particle motion measurements from pile-driving are not available, comparisons of our results can only be made with other types of anthropogenic activities. Measured source level (SL_{1m}) particle acceleration from a wind turbine in the Baltic Sea during operation (wind speed 8 m/s) was estimated to be $1.1 \times 10^{-2} \text{ m/s}^2$ (rms) in the frequency interval 2-200 Hz (Sigray *et al.* 2009). This is a half to one third of the average particle acceleration measured in our study ($2.9 \times 10^{-2} \text{ m/s}^2$ peak (10-300 Hz)). Sigray *et al.* (2009) also determined the attenuation of propagation of particle acceleration (in terms of amplitude) to be $r^{-0.7}$, whereas our study found it to be $r^{-0.92}$. Both these results suggest that the character of propagation is described as “between” cylindrical ($r^{-0.5}$) and spherical (r^{-1}) and that the sound propagation is site specific. The ambient noise in the Baltic Sea was measured to be $3.0 \times 10^{-4} \text{ m/s}^2$ (rms) (2-200 Hz) compared to our study where it was $8.6 \times 10^{-5} \text{ m/s}^2$ (rms) (10-300 Hz). These results indicate that the ambient noise with regards to particle motion at the field site was low. This corresponds well with the results from of the ambient sound pressure levels at the field site that had values between 110 dB re $1 \mu\text{Pa}$ (rms) and 119 dB re $1 \mu\text{Pa}$ (rms) depending on weather conditions. Both values are in the medium range although it is difficult to compare broadband levels to 1/3 octave band levels (see Madsen *et al.* 2006, Thomsen *et al.* 2006).

5.3 Behavioural response in cod and sole

To our knowledge, there have been only two other studies performed on the effects of pile-driving noise on fish. Abbot *et al.* (2005, cited in Popper & Hastings 2009a) found no behavioural effects of pile-driving sounds in caged shiner surfperch *Cymatogaster aggregata*, Chinook salmon *Oncorhynchus tshawytscha* (Walbaum) and northern anchovy *Engraulis mordax*. Yet, according to Popper and Hastings (2009), the behavioural analysis was performed after the fish had been removed from test cages and the results are therefore difficult to interpret. Nedwell *et al.* (2003) placed farmed brown trout (*Salmo trutta*) in cages positioned at different distances from vibro and impact pile-driving operations in Southampton harbour and filmed them using close-circuit television monitoring. ‘Startle-reactions’ and ‘Fish activity level’ were investigated prior to and during pile-driving (but not after the event), with activity levels measured by counting the number of times a fish entered the camera’s field of view within a two-minute observation period. The observations revealed no evidence that trout reacted to impact pile-driving at 400 m (average received sound pressure level = 134 dB re $1 \mu\text{Pa}$), nor to vibration pile-driving at close ranges (<50 m; average received sound pressure level not given). However, received sound pressure levels were relatively low compared to our study and the species used has relatively poor sensitivity (for a detailed critical review of the study see Hastings & Popper 2005). Behavioural reactions of fish to other impulsive sounds have been reported, for example seismic airguns at distances of more than 20 km from the source (e.g. Engås *et al.* 1996; see also Slotte *et al.* 2004, Wardle *et al.* 2001, reviews by Popper & Hastings 2009b, a). Yet, extrapolating these results to pile-driving is difficult as the impact sounds differ in certain features e.g. duty cycle, directionality, bandwidth (OSPAR 2009).

Although we found clear reactions to the playback sounds, there was considerable variability across subjects and we were not able to find an obvious relationship between the level of exposure and the extent of the behavioural response. This is not surprising as it has been suggested that response of fish to sound varies with a variety of internal and external factors (e.g. age, sex, condition, season; see (Popper *et al.* 2004, Thomsen *et al.* 2006). Another investigation using playbacks of seven

electronically generated sounds to a variety of species (flounder, *Platichthys flesus*; goldfish, *Carassius auratus*; rockling, *Ciliata mustela*; sand smelt, *Atherina presbyter*; smelt, *Osmerus eperlanus* and dab, *Limanda limanda*) found a graded behavioural reaction with increasing sound pressure levels probably indicative of individual variability in sensitivity to sound disturbance (Nedwell *et al.* 2007b). The variety of responses found in our study is in line with other investigations. For example, observations by Andersson *et al.* (2007) on three-spined stickleback (*Gasterosteus aculeatus*), showed a wide variety of types of reactions of single tones and broadband operational wind turbine noise.

The frequency of the sound broadcast in our experiments fell well within the best hearing range of cod (see Chapman & Hawkins 1973, Offutt 1974) and some of the experimental subjects clearly increased their overall swimming speed during playback. It is reasonable to assume that in a relatively mobile species such as cod there would be more inter-individual differences in swimming speed compared to a more benthic/sedentary species such as sole and therefore a higher sample size might be necessary to demonstrate an increase of swimming speed statistically. Clear directional responses were mostly observed when the sound was presented for the first time, and the higher overall swimming speed during playbacks indicates that the fish tried to swim away from the sound source. Especially close to the sound source, cod would have sensed not only sound pressure but particle motion which is supposed to be an adequate stimulus for directional hearing (Buwalda *et al.* 1983, Hawkins & Sand 1977, Schuijf 1975) and therefore a movement away from the sound source would have been a likely initial reaction.

A clear response to sound is not necessarily directed away from the sound source as it can also be comprised of a vertical movement (Turnpenny & Nedwell 1994). McCauley *et al.* (2000) observed pink snapper (*Chrysophrys auratus*) in a net cage during air-gun shots and the swimming direction was towards the sea bed rather than away from the sound source. This effect was most pronounced during the first exposure while in further experiments the fish reacted less strongly indicating either habituation or hearing loss. Future studies using movement tags could help investigate the vertical movement of fish in response to pile-driving sound.

As described in cod, the individual variations in sole were large as well. Overall, the reactions of sole to the sound were stronger than expected since sole is only sensitive to particle motion which decreases strongly over short distances. In the near mesocosm, where significant reactions were observed sole were exposed to particle acceleration between 6.51×10^{-3} and $8.62 \times 10^{-4} \text{ m/s}^2$ peak, while it was 6.61×10^{-4} to $4.13 \times 10^{-4} \text{ m/s}^2$ peak in the far mesocosm. In other studies carried out on cyprinids, eel and juvenile salmon, strong escape reactions were observed when individuals were exposed to particle accelerations between $3.0 \times 10^{-3} - 1.0 \times 10^{-2} \text{ m/s}^2$ (rms) in the infrasound frequencies (<20 Hz) generated by a sound projector in front of inlets to power plants or other constructions in lakes and rivers (Knudsen *et al.* 1994, Sand *et al.* 2000, Sonny *et al.* 2006). The lowest levels in these studies are comparable with the highest levels sole was exposed to in our experiments and at which significant reactions were observed. Since these infrasound studies focussed on stronger reactions, subtle behavioural reactions might have been missed at lower levels of particle motion similar to those in our experiments. Flatfish such as sole spend much of their time half buried into the sediment. Gibson (1975) observed plaice only spending 6% of their time swimming with higher activity during the day. The higher activity in day time was mostly related to food searching on the seabed (De Groot 1964, Gibson 1976, Verheijen & De Groot 1967). A typical reaction to disturbance in flatfish is to freeze and make itself invisible in the sand (a reaction that made recovery of sole by divers after the experiments very difficult). Therefore, less obvious avoidance reactions but more freezing response was expected in the experiments. This result is of special importance since the particle motion in the experiments was produced by the loudspeaker 2.5 m above the sea bed. In actual pile-driving activities particle motion will be generated not only in the water column but in the sea bed and will travel through the sediment (Hawkins 2009). Therefore

flatfish will most likely be exposed to much higher particle motion than measured in the present experiments. However, the levels of particle motion generated during pile-driving and the distance at which it can be detectable are not known. This is an important gap in knowledge that needs to be addressed in future studies.

To estimate an effect of sound on fish, reaction thresholds need to be determined. These thresholds in combination with sound measurements around a sound source could help to estimate the range at which fish might be affected by the sound. Knudsen *et al.* (1992) defined three different thresholds that are important in investigations of the reactions to sound in fish. While the absolute hearing threshold (in the absence of masking noise) is rather constant, the awareness reaction threshold depends on the physiological state of the fish and the behavioural conditions as well as, for example, the time of the day/year (see also Neproshin 1979). The third threshold is the avoidance response threshold which depends on the present situation of the fish. For example, a fish that is hidden/protected will have a higher avoidance response threshold than a fish that is more exposed (Knudsen *et al.* 1992).

In addition, the reaction of fish to sound most likely depends not only on its hearing ability but on the ability to separate a signal from the background noise (signal to noise ratio). Especially in a relatively noisy environment such as the sea, the ability to discriminate between a signal and the background noise might be more important than the absolute hearing threshold (Hawkins & Chapman 1975). For cod Chapman & Hawkins (1973) determined a signal to noise ratio of 16 dB, i.e. a signal needs to exceed the background level by 16 dB to be detected. Our calculations made it clear that in all cases in the present experiments this level was exceeded but since the pile-driving signals were measured in dB_{peak} and the background noise in dB_{rms} a precise evaluation of the signal to noise ratio at which behavioural responses were triggered cannot be made (see also Madsen 2005). It has to be noted though that there is uncertainty over the issue of signal to noise ratio in behavioural experiments. For example, cod and haddock were expected to react to airgun noise 20 dB above the detection threshold but catch experiments carried out indicated reactions at much lower sound levels (Engås *et al.* 1996). The measurements of particle motion in the near mesocosm showed 10-100 times higher values during playback compared with the ambient noise level and still about 10 times higher values in the far mesocosm which is indicative of a very high signal to noise ratio.

Alternatively reaction thresholds can be given as values above hearing sensitivity as indicated by the audiogram (see Nedwell *et al.* 2007b). For example, Mitson (2000) determined a threshold for avoidance reaction in cod of 30 dB above hearing threshold. Cod can hear sound at 100 Hz above a threshold of about 77 dB re 1µPa (rms) and our lower threshold values for this species (140 dB re 1µPa peak) at least indicates a higher threshold above audiogram as indicated by Mitson (2000). In further studies the rms-values given for background noise and the peak-values given for reaction threshold ranges need to be related to each other more conclusively to produce a complete picture of behavioural thresholds.

Habituation? As observed in both cod and sole, a directional response to the sound was mostly observed when sound was presented for the first time. Also, changes in overall swimming speed were less pronounced when the fish were exposed to a larger number of experiments. Both results point toward habituation to the sound. However, individual swimming speed did not show a clear trend of decreasing strength of reaction, possibly because individuals vary in their speed of habituation? Stress, reduced fitness and masking of biologically important sounds (e.g. mating calls in cod) may still occur even in fish habituated to the sound (see Bejder *et al.* 2009).

5.4 Implications for environmental management

We believe that our study has reduced the uncertainty about the nature and range of behavioural reactions of marine fish to pile-driving noise considerably. We conclude that cod will react to signals simulating pile-driving sound at received sound pressure levels that are indicative of relatively large distances from an operating pile-driver. Figure 42 shows the cod thresholds found here in light of previous sound measurements at various offshore wind farm construction sites (Betke 2008). Based on actual measurements and resulting interpolated normalised peak levels at 750 m, we have modelled received sound pressure levels up to 100 km (= upper limit of reliable modelling) with the lowest and highest transmission loss values documented at offshore wind farm sites to date (15 log (r) and 22 log (r) (see Betke 2008, Madsen *et al.* 2006, Thomsen *et al.* 2006). We then plotted the sound pressure level lower and upper values for which we found behavioural reactions in our experiments (see chapter 4). Looking at our data, reactions would occur at ranges between 7.5 km (cod higher reaction threshold; TL = 22 log (r) and 70 km (cod lower threshold; TL = 22 log (r)). As indicated in Figure 42, at least in theory, behavioural reactions could occur at much longer distances than that.

Yet, the indicated ranges have to be viewed with caution as transmission loss is highly site dependent and behavioural reactions might be very much influenced by the ratio between ambient noise and signal which is site specific as well (see above and for example Nedwell *et al.* 2007a). We also emphasised earlier that behavioural reactions are expected to vary on a continuous scale depending on many internal and external factors. Nonetheless, our study confirms the assessment of Thomsen *et al.* (2006), Thomsen & Judd (in press) that behavioural response of fish to pile-driving sound might happen at relatively large spatial scales.

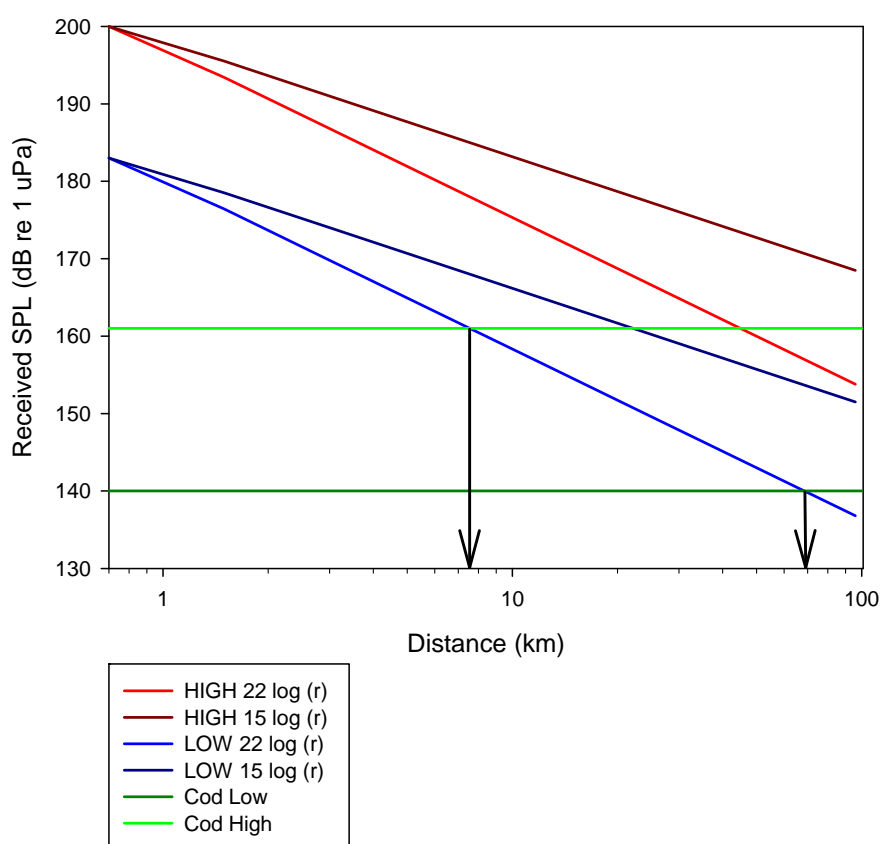

Figure 42: Lower and upper range of behavioural response of both fish species based on the peak levels that elicited a response (Peak sound pressure levels normalised to 750 m, dB re 1 μ Pa, based on 13 measurements from eight sources, see Betke (2008); TL = 22 log (r) and 15 log(r); data < 100 km).

But our study has also immense impact for management of sole. This is the first study that provides threshold ranges for particle motion in sole. Although it is not possible to relate these data to distance ranges around pile-driving activity yet, the data can be used to determine ranges as soon as particle motion measurements during pile-driving are available.

While we are confident that our results indicate pile-driving sounds can have an effect on behaviour, it is difficult to extrapolate from our results the nature of the behavioural reaction of cod and sole to pile-driving sounds. We found alterations of swimming speed, documented a freezing response and could show some movements away from the sound which all might point towards avoidance reactions. Yet, our sample of individuals was not representative of the whole range of age classes and physiological states of the species under investigations. Also, in the real world, the benefits of staying in an area (food, reproduction) might outweigh costs due to sound exposure and reactions might therefore not be that straightforward to interpret (see McGregor 2007). We also found indications of habituation, although our data on this topic is rather limited. Yet, habituation is not necessarily a 'good thing' as there are costs involved as well (see Bejder *et al.* 2009).

In our view, the main implications of our study for management are threefold.

- First, the theoretical concerns rose about the potential effects of pile-driving noise on fish (see Thomsen *et al.* 2006) were well founded. This is an important result. To date, the restrictions and management options (e.g. reduced pile-driving during sensitive periods, sound measurements, and fish surveys) that have been imposed on developers at offshore wind farm construction sites have been due to the precautionary principle. Our study indicates to both regulators and developers that the costs imposed by these measures go some of the way to addressing a real problem.
- Second, and perhaps more concrete, we suggest that our preliminary behavioural thresholds are considered in impact assessments of offshore wind farms in the UK and elsewhere. Cod and sole would then act as model species for fish with good and relatively poor (respectively) sensitivity to underwater sound. The particle motion and SPL values found here can be incorporated into any transmission loss model and compared also with measurements from construction sites during pile-driving, to indicate behavioural response zones (see for example Thomsen *et al.* 2006). Together with data on the ecological importance of the habitat for the different fish species that is gathered during the monitoring phase, the assessment of site specific impacts could be much more thoroughly undertaken than before.
- Third, mitigation measures should be further discussed, developed and applied, especially if these could lead to a reduction of acoustic energy that is emitted into the water column. OSPAR (2009) discusses several promising options. Further developments of mitigation measures could therefore target frequencies that are of relevance for fish as well.

5.5 Future studies and improvement of design

Future studies should comprise controlled exposure experiments with an improved design, as well as empirical investigations at offshore wind farm sites to validate the experimental finding.

Our experimental design could be improved in three ways:

- Using of a real pile-driver to create higher sound pressure levels and realistic particle motion components. This could also be used to investigate sediment transmission of sound / particle motion. However, such a design would require monitoring of received levels and there would be no experimental control over the emitted sound intensity.

- Usage of wild cod stocks to validate findings based on the farmed cod and to provide a better comparison to the sole data.
- Investigations using spawning fish to investigate behavioural reactions at critical reproductive times and analyse effects of pile-driving on calling behaviour.

In addition field studies using catch rates before, during and after pile-driving have proven to be feasible in investigation of cod and seismic surveys. Yet, impact and control areas have to be very carefully designed in order to gain feasible datasets (see OSPAR 2009) for a discussion).

6 Conclusions

Table 7 Overview of the objectives and relevant results of the study.

Objective	Results
Understand the effects of pile-driving sound sources on the behaviour of marine fish	First field relevant experimental proof that pile-driving sound affects the behaviour of cod and sole
Identify the threshold of exposure that lead to behavioural responses	Not a single threshold but range over which behavioural response occurs; cod = 140-161 dB re 1 μ Pa peak; sole = 144-156 dB re 1 μ Pa peak, particle motion between 6.51x10 ⁻³ and 8.62 x10 ⁻⁴ m/s ² peak
Define the characteristics, scale and duration of responses as a function of exposure conditions	Cod = tendency for higher swimming speed, significant freezing response, documented initial avoidance; Sole = significant increase in swimming speed, and initial avoidance
Interpret the results with regard to pile-driving operations in the marine environment	Reduction of uncertainty about behavioural reaction of marine fish to pile-driving sound; Incorporation of results of this study into offshore wind farm EIAs; further development of mitigation measures

As can be seen in Table 7, we were able to achieve all of the objectives of the study. It has to be emphasised that our study is the first that proves behavioural response of marine fish to pile-driving driving at a scale and in circumstances applicable to the coastal/offshore environment where wind farms are located. Yet, instead of one threshold for behavioural response, we found a range of received sound pressure levels at which sole and cod react. This has important implications for management as we believe that any assessment proposing only single thresholds (e.g. Nedwell *et al.* 2007a) should be viewed with caution. We also found a range of reactions with significant differences across the test species indicating that impact assessments providing impacts zones for all marine fish fall short of their objective. Finally, we believe that our investigation has important further implications for management of pile-driving sound, reducing uncertainty on effects and thereby guaranteeing that novel and important industries such as marine wind farms can be implemented with a consideration of reducing the environmental impact/footprint.

7 Acknowledgements

We would like to thank Tim Atack, Jim Treasurer and the staff at Ardtoe Marine Lab. John MacMillan, the staff of FishDive, Craig Burton, Pete Planning and Hugh MacPherson were or great help for the field work and Tony Kenning and the skipper and crew of the FV Contest provided us with sole for the experiments; Harriet Salomonsen from Bangor University did a great job in supporting the field work and helping out wherever a hand was needed. We are also grateful to Klaus Betke from Itap for providing sound samples and advice. Thanks a lot Brigitte Ruiz from COWRIE. At Cefas we would like to thank Allan Emery, Stuart Hetherington, Clare Adams, Joanna Walton and Susana Barquero-Molina for their support. The participation of Stockholm University was funded by the research programme VINDVAL, coordinated by the Swedish Energy Agency and the Swedish Environmental Protection Agency. We would also like to thank the staff at the Department of Underwater Research at the Swedish Defence Research Agency (FOI) for their contribution.

8 References

- Andersson MH, Dock-Åkerman E, Ubral-Hedenberg R, Öhman MC, P. S (2007) Swimming Behavior of Roach (*Rutilus rutilus*) and Three-spined Stickleback (*Gasterosteus aculeatus*) in Response to Wind Power Noise and Single-tone Frequencies. *AMBIO: A Journal of the Human Environment* 36:636-638
- Bass AH, Clark CW (2003) The Physical Acoustics of Underwater Sound Communication. In: Simmons AM, Popper AN, Fay RR (eds) *Acoustic Communication*. Springer Verlag New York, p 404
- Batschelet E (1981) *Circular Statistics in Biology*, Vol. Academic press, London, New York, Toronto, Sydney, San Francisco
- Bejder L, Samuels A, Whitehead H, Finn H, Allen S (2009) Impact assessment research: use and misuse of habituation, sensitisation and tolerance in describing wildlife responses to anthropogenic stimuli. *Marine Ecology Progress Series* 395:177-185
- Betke K (2008) Measurement of wind turbine construction noise at Horns Rev II - Unpublished report submitted to Bioconsult SH, Itap Oldenburg
- Buwalda RJA, Schuijf A, Hawkins AD (1983) Discrimination by the cod of sounds from opposing directions. *Journal of Comparative Physiology A: Neuroethology, Sensory, Neural, and Behavioral Physiology* 150:175-184
- Chapman CJ, Hawkins AD (1973) A field study of hearing in cod, *Gadus morhua*. *Journal of Comparative Physiology A* 85:147-167
- De Groot S (1964) Diurnal activity and feeding habits of plaice. *Rapports et procès-verbaux des réunions - International Council for Exploration of the Sea* 155:48-51
- Engås A, Løkkeborg S, Ona E, Soldal A, V. (1996) Effects of seismic shooting on local abundance and catch rates of cod (*Gadus morhua*) and haddock (*Melanogrammus aeglefinus*). *Canadian Journal of Fisheries and Aquatic Sciences* 53:2238-2249
- Gibson RN (1975) A comparison of field and laboratory activity patterns of juvenile plaice. In: Barnes HB (ed) *Ninth European Marine Biology Symposium*. *European Marine Biology Symposia*, Aberdeen, p 13-28
- Gibson RN (1976) Comparative studies on the rhythms of juvenile flatfish. In: De Coursey PJ (ed) *Biological rhythms in the marine environment*, Vol 4. The Belle W. Baruch Library in marine science. University of South Carolina, p 199-214
- Hastings MC, Popper AN (2005) *Effects Of Sound On Fish Contract 43A0139 Task Order 1*, California Department Of Transportation
- Hawkins AD (2009) The impact of pile driving upon fish. *Proceedings of the Institute of Acoustics Fifth International Conference on Bio-Acoustics*, Loughborough, p 69-76
- Hawkins AD, Chapman CJ (1975) Masked Auditory Thresholds in the Cod, *Gadus morhua* L. *Journal of Comparative Physiology A* 103:209-226
- Hawkins AD, Sand O (1977) Directional hearing in the median vertical plane by the cod. *Journal of Comparative Physiology A: Neuroethology, Sensory, Neural, and Behavioral Physiology* 122:1-8
- Hooge PN, Eichenlaub B (2000) *Animal movement extension to Arcview. ver. 2.0*. Alaska Science Center. Biological Science Office, U.S. Geological Survey, Anchorage, AK, USA.
- Hooge PN, Eichenlaub WM, Solomon EK (2000) Using GIS to analyze animal movements in the marine environment. In: G.H. Kruse, N. Bez, A. Booth, M.W. Dorn, S. Hills, R.N. Lipcius, D. Pelletier, C. Roy, S.J. Smith, Witherell D (eds) *Spatial Processes and Management of Marine Population 17th Lowell Wakefield Fisheries Symposium*, p 37-51
- Hunter E, Aldridge JN, Metcalfe JD, Arnold GP (2003) Geolocation of free-ranging fish on the European continental shelf as determined from environmental variables. *Marine Biology* 142:601-609
- Janik VM (2009) Acoustic communication in delphinids. In: Naguib M, Janik VM (eds) *Advances in the Study of Behaviour*, Vol 40. Academic Press, Burlington p123-157
- Jones KMM (2005) Home range areas and activity centres in six species of Caribbean wrasses (Labridae). *Journal of Fish Biology* 66:150-166
- Knudsen FR, Enger PS, Sand O (1992) Awareness reactions and avoidance responses to sound in juvenile Atlantic salmon, *Salmo salar* L. *Journal of Fish Biology* 40:523-534
- Knudsen FR, Enger PS, Sand O (1994) Avoidance responses to low frequency sound in downstream migrating Atlantic salmon smolt, *Salmo salar*. *Journal of Fish Biology* 45:227-233

- Madsen PT (2005) Marine mammals and noise: problems with root mean square sound pressure levels for transients. *Journal of the Acoustical Society of America* 117:3952-3957
- Madsen PT, Wahlberg M, Tougaard J, Lucke K, Tyack P (2006) Wind turbine underwater noise and marine mammals: implications of current knowledge and data needs. *Marine Ecology Progress Series* 309:279-295
- McCauley RD, Fewtrell J, Duncan AJ, Jenner C, Jenner M-N, Penrose JD, Prince RIT, Adhitya A, Murdoch J, McCabe K (2000) Marine seismic surveys: a study of environmental implications. *APPEA Journal* 2000:692-708
- McGregor PK (2007) Designing experiments to test for behavioural effects of sound International Conference on the Effects of Noise on Aquatic Life, Nyborg Denmark
- Mitson RB (2000) ICES Cooperative Research Report 209: Five Years On. - ICES Fisheries Acoustic Science & Technology Working Group, Haarlem, Netherlands, p 7
- Mueller-Blenkle C, Jones EG, Thomsen F, Elepfandt A, Lüdemann K, Kafemann R, Johnstone ADF, Reid DG (Submitted) Behavioural reactions of cod (*Gadus morhua*) to low frequency sound and implications for marine environmental management. *ICES Journal of Marine Science*
- Nedwell JR, Parvin SJ, Edwards B, Workman R, Brooker AG, Kynoch JE (2007a) Measurement and interpretation of underwater noise during construction and operation of offshore windfarms in UK waters, Report for COWRIE, Newbury, UK
- Nedwell JR, Turnpenny A, Langworthy J, Edwards B (2003) Measurements of underwater noise during piling at the Red Funnel Terminal, Southampton, and conservations of its effect on caged fish, Subacoustics LTD. Report 558 R 0207.
- Nedwell JR, Turnpenny AWH, Lovell J, Parvin SJ, Workman R, Spinks JAL, Howell D (2007b) A validation of the dBht as a measure of the behavioural and auditory effects of underwater noise - Subacoustech Report Reference: 534R1231 to Chevron Ltd, TotalFinaElf Exploration UK PLC, Department of Business, Enterprise and Regulatory Reform, Shell UK, ITF, JNCC, Subacoustech, Southampton
- Neproshin AY (1979) Behavior of the Pacific mackerel, *Pneumatophorus japonicus*, when affected by vessel noise. *Journal of Ichthyology* 18:695-699
- Offutt GC (1974) Structures for the detection of acoustic stimuli in the Atlantic codfish, *Gadus morhua*. *Journal of the Acoustical Society of America* 56:665-671
- OSPAR (2009) Overview of the impacts of anthropogenic underwater sound in the marine environment, OSPAR Convention for the Protection of the Marine Environment of the North-East Atlantic (www.ospar.org)
- Parvulescu A (1964) Problems of Propagation and Processing. In: Tavolga WN, Popper AN, Fay RR (eds) *Marine Bio Acoustics Vol 1*, p 87-100
- Popper AN, Fay RR, Platt C, Sand O (2003) Sound Detection Mechanisms and Capabilities of Teleost Fishes. In: Collin SP, Marshall NJ (eds) *Sensory Processing in Aquatic Environments*. Springer Verlag, New York, p 3-38
- Popper AN, Fewtrell J, Smith ME, McCauley RD (2004) Anthropogenic sound: Effects on the behavior and physiology of fishes. *Marine Technology Society Journal* 37:35-40
- Popper AN, Hastings MC (2009a) The effects of anthropogenic sources of sound on fishes. *Journal of Fish Biology* 75:455-489
- Popper AN, Hastings MC (2009b) The effects of human-generated sound on fish. *Integrative Zoology* 4:43-52
- Righton D, Kjesbu OS, Metcalfe J (2006) A field and experimental evaluation of the effect of data storage tags on the growth of cod. *Journal of Fish Biology* 68:385-400
- Righton D, Mills C (2006) Application of GIS to investigate the use of space in coral reef fish: a comparison of territorial behaviour in two Red Sea butterflyfishes. *International Journal of Geographical Information Science* 20:215-232
- Sand O, Enger PS, Karlsen HE, Knudsen F, Kvernstuen T (2000) Avoidance Responses to Infrasound in Downstream Migrating European Silver Eels, *Anguilla anguilla*. *Environmental Biology of Fishes* 57:327-336
- Schuijf A (1975) Directional hearing of cod (*Gadus morhua*) under approximate free field conditions. *Journal of Comparative Physiology A: Neuroethology, Sensory, Neural, and Behavioral Physiology* 98:307-332
- Seaman DE, Powell RA (1996) An Evaluation of the Accuracy of Kernel Density Estimators for Home Range Analysis. *Ecology* 77:2075-2085
- Sigray P, Andersson MH, Fristed T (2009) Partikelrörelser i vattnet vid ett vindkraftsverk - Akustisk störning. Rapport 5963-7, Naturvårdsverket. ISBN 978-91-620-5963-7.pdf

- Slotte A, Hansen K, Dalen J, Ona E (2004) Acoustic mapping of pelagic fish distribution and abundance in relation to a seismic shooting area off the Norwegian west coast. *Fisheries Research* 67:143-150
- Sonny D, Knudsen FR, Enger PS, Kvernstuen T, Sand O (2006) Reactions of cyprinids to infrasound in a lake and at the cooling water inlet of a nuclear power plant. *Journal of Fish Biology* 69:735-748
- Thomsen F, Judd A (in press) Assessing and managing the potential effects of pile driving sounds on marine fish from an UK perspective. *Marine Pollution Bulletin*
- Thomsen F, Lüdemann K, Kafemann R, Piper W (2006) Effects of offshore wind farm noise on marine mammals and fish, biola, Hamburg, Germany on behalf of COWRIE Ltd, Newbury, UK
- Turnpenny AWH, Nedwell JR (1994) The effects on marine fish, diving mammals and birds of underwater sound generated by seismic surveys. - Consultancy Report FCR 089/94, Fawley Aquatic Research Laboratories Ltd.
- Tyack PL, Clark CW (2000) Communication and acoustic behavior of dolphins and whales. In: Au W, Popper AN, Fay R (eds) *Hearing by Whales and Dolphins-Springer Handbook of Auditory Research Series*. Springer, New York, p 156-224
- Urick R (1983) *Principles of underwater sound*, Vol 1. McGraw Hill, New York
- Verheijen FJ, De Groot SJ (1967) Diurnal activity pattern of plaice and flounder (pleuronectidae) in aquaria. *Netherlands Journal of Sea Research* 3:383-390
- Wardle CS, Carter TJ, Urquhart GG, Johnstone ADF, Ziolkowski AM, Hampson G, Mackie D (2001) Effects of seismic airguns on marine fish. *Cont Shelf Res* 21:1005-1027
- Worton BJ (1987) A review of models of home range for animal movement. *Ecological Modelling* 38:277-298

9 Appendix

Appendix Table 1: Data summary current speed and temperature at experimental days

	current speed [cm/s]			Temperature [°C]			readings
	average	Min	max	average	Min	max	
24.7.09	3.85	0.50	7.46	12.6	12.0	13.0	96
26.7.09	4.13	0.88	8.55	12.5	12.0	12.5	96
28.7.09	3.31	1.27	5.34	12.5	12.5	12.5	96
1.8.09	3.22	0.44	5.20	13.0	13.0	14.0	96
3.8.09	4.33	3.15	5.97	13.0	13.0	13.0	96
5.8.09	3.68	0.99	5.66	13.0	13.0	13.0	96
19.8.09	2.90	0.89	6.67	13.5	13.5	13.5	96
21.8.09	2.94	1.02	6.80	13.5	13.5	13.5	96
23.8.09	3.03	0.65	5.82	13.5	13.5	13.5	96
25.8.09	2.07	0.23	4.86	13.5	13.5	13.5	96
27.8.09	2.42	0.76	4.11	13.5	13.5	13.5	96
14.9.09	3.02	0.54	4.77	13.5	13.5	13.5	96
18.9.09	2.33	0.11	7.11	13.5	13.5	13.5	96
20.9.09	2.26	0.12	6.92	13.5	13.5	13.5	96

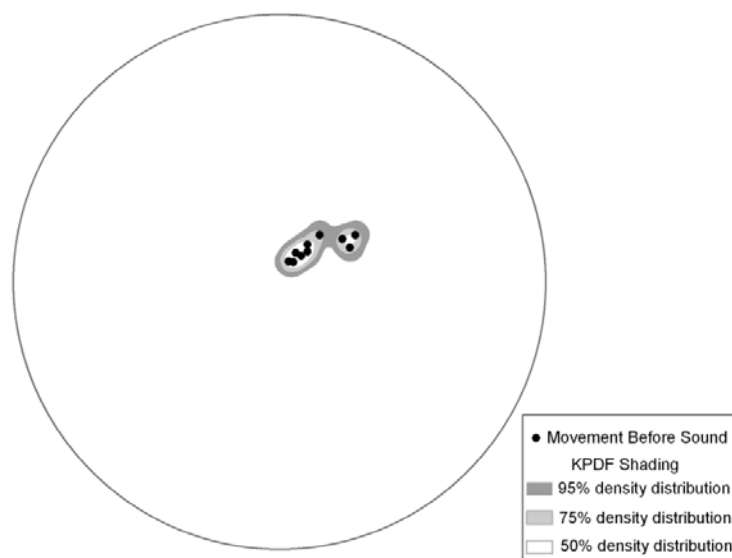

Appendix Figure 1: Kernel probability density function surfaces of an individual sole, showing the range of movement before sound exposure. Experiment carried out on the 25th of August in the near mesocosm. The sound pressure level inside the mesocosm was between 146 and 152 dB re 1 μ Pa the particle acceleration from 6.5×10^{-3} to 8.6×10^{-4} m/s² peak. The experimental conditions were incoming tide, water depth 13 m, light to moderate wind, waves estimated 0.05-0.1m.

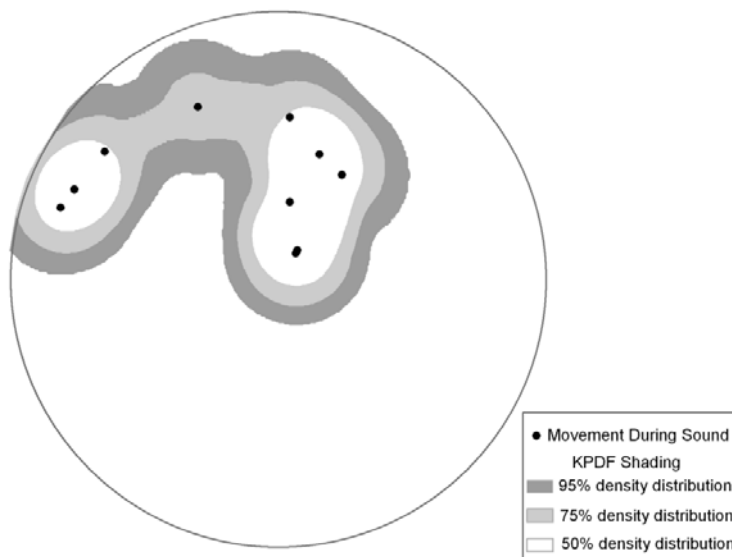

Appendix Figure 2: Kernel probability density function surfaces of an individual sole, showing the range of movement during sound exposure. Experiment carried out on the 25th of August in the near mesocosm. The sound pressure level inside the mesocosm was between 146 and 152 dB re 1 μ Pa the particle acceleration from 6.5×10^{-3} to 8.6×10^{-4} m/s² peak. The experimental conditions were incoming tide, water depth 13 m, light to moderate wind, waves estimated 0.05-0.1m.

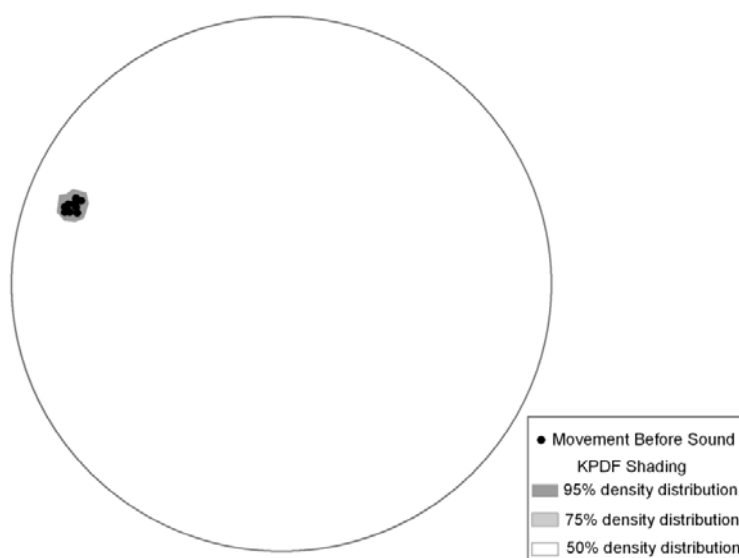

Appendix Figure 3: Kernel probability density function surfaces of an individual sole, showing the range of movement after sound exposure. Experiment carried out on the 25th of August in the near mesocosm. The sound pressure level inside the mesocosm was between 146 and 152 dB re 1 μ Pa the particle acceleration from 6.5×10^{-3} to 8.6×10^{-4} m/s² peak. The experimental conditions were incoming tide, water depth 13 m, light to moderate wind, waves estimated 0.05-0.1m.

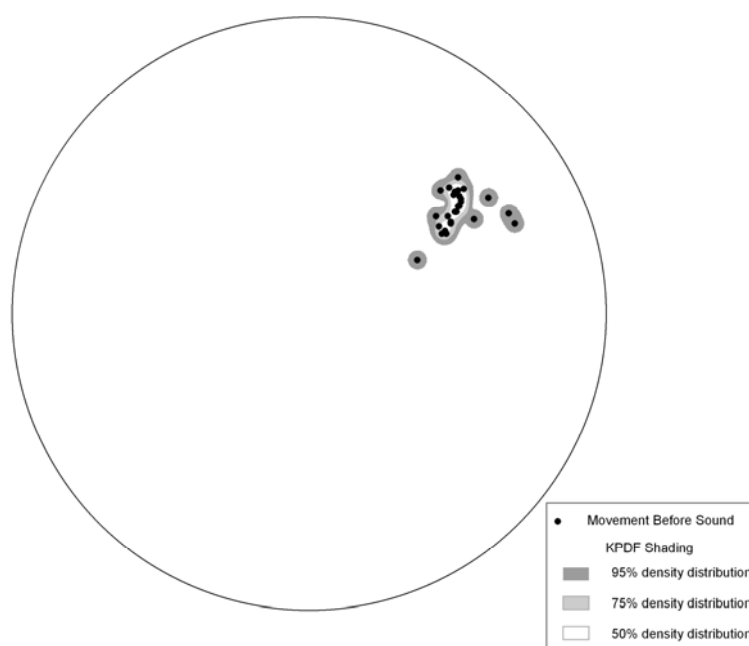

Appendix Figure 4: Kernel probability density function surfaces of an individual cod, showing the range of movement before sound exposure. Observations were obtained in the distant mesocosm. Average received sound pressure level 133 - 143 dB re 1 μ Pa (see Figure 13), particle acceleration from 6.6×10^{-4} to 4.1×10^{-4} m/s² peak. Weather conditions: outgoing tide, water depth 11 m, light rain, wind estimated 3-4ms⁻¹, waves estimated 0.1 m).

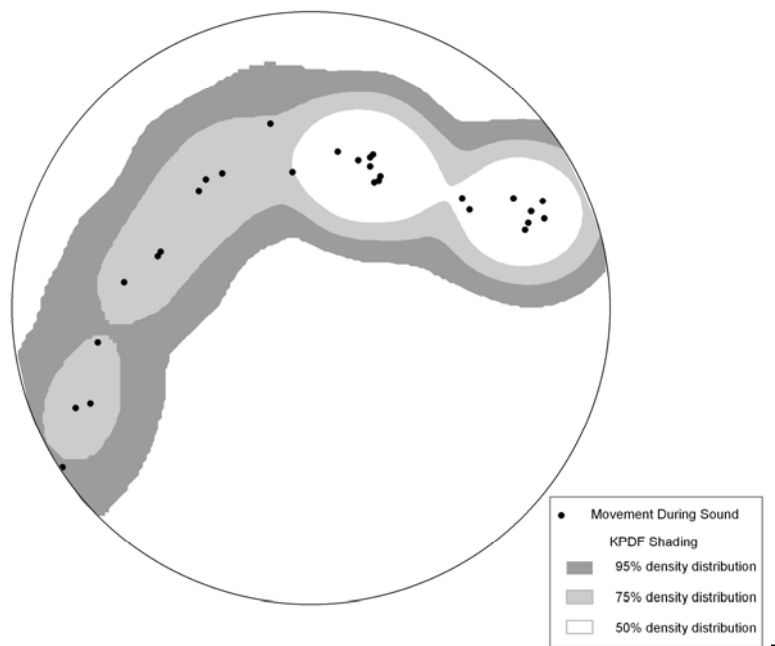

Appendix Figure 5: Kernel probability density function surfaces of an individual cod, showing the range of movement during sound exposure. Observations were obtained in the distant mesocosm. Average received sound pressure level 133 - 143 dB re 1 μ Pa (see Figure 13), particle acceleration from 6.6×10^{-4} to 4.1×10^{-4} m/s² peak. Weather conditions: outgoing tide, water depth 11 m, light rain, wind estimated 3-4ms⁻¹, waves estimated 0.1 m).

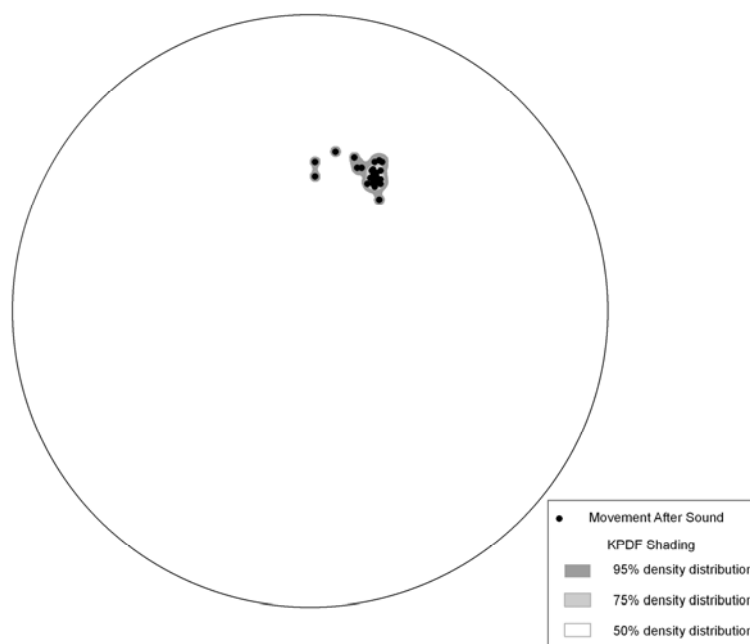

Appendix Figure 6: Kernel probability density function surfaces of an individual cod, showing the range of movement after sound exposure. Observations were obtained in the distant mesocosm. Average received sound pressure level 133 - 143 dB re 1 μ Pa (see Figure 13), particle acceleration from 6.6×10^{-4} to 4.1×10^{-4} m/s² peak. Weather conditions: outgoing tide, water depth 11 m, light rain, wind estimated 3-4ms⁻¹, waves estimated 0.1 m).

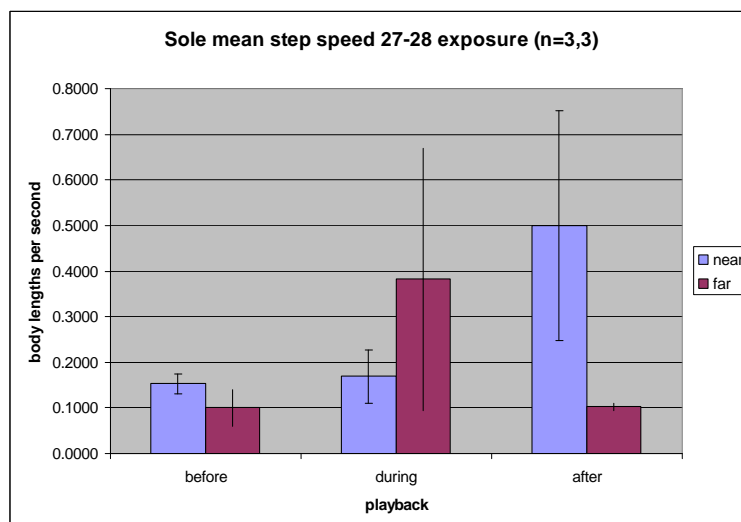
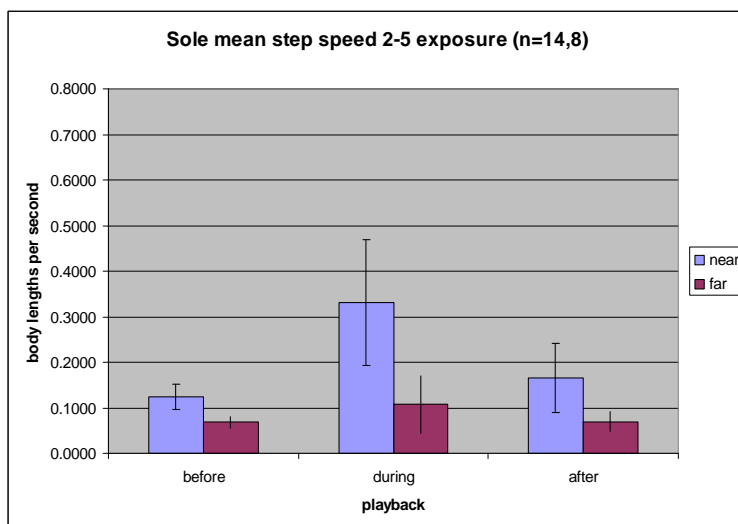
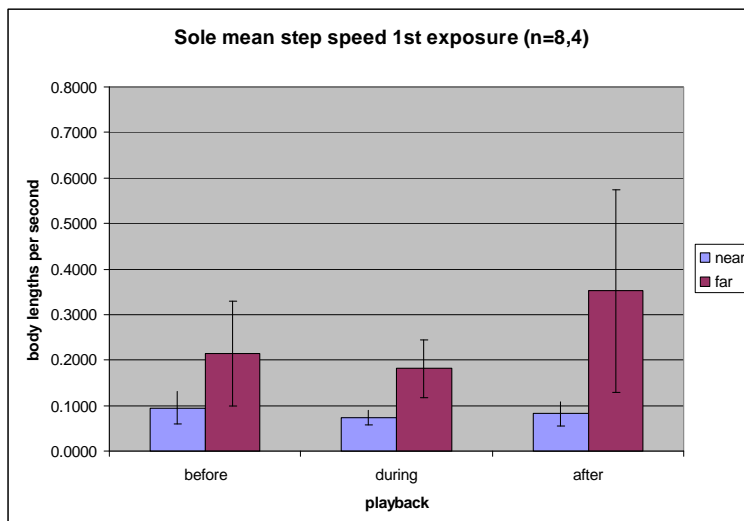

Appendix Figure 7: Mean step speed within the periods of trials for sole exposed to different numbers of playback in the near and far mesocosm.

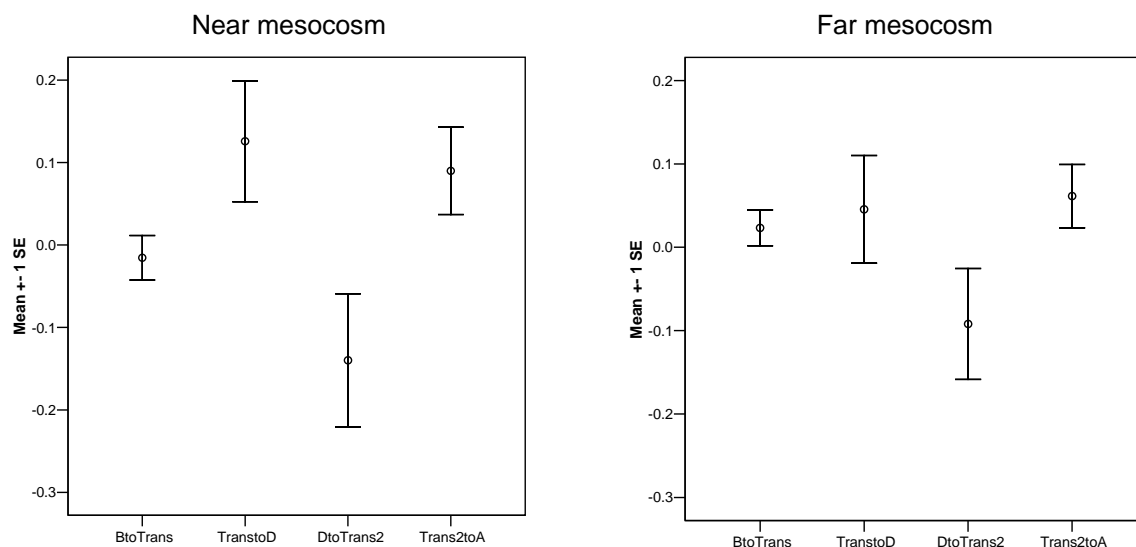

Appendix Figure 8: Change in step speed between the variables Before, BtoD, During, DtoA, After. This gives 4 changes: Before to BtoA (*BtoTrans*), BtoA to During (*TranstoD*), During to DtoA (*DtoTrans2*), and DtoA to After (*Trans2toA*) in sole. In both mesocosms there is a suggestion of speed fall *During* to *DtoA*, but there is no significant effect of transition in either mesocosm: (non-parametric repeated measures 1-way AOV; near: $H = 2.42$, $df = 3$, $P = 0.489$; far: $H = 1.96$, $df = 3$, $P = 0.581$). Sound pressure level in the in the near mesocosm between 144 and 156 dB re $1\mu\text{Pa}$, particle acceleration from 6.5×10^{-3} to $8.6 \times 10^{-4} \text{ m/s}^2$ peak) and in the far mesocosm between 132 and 146 dB re $1\mu\text{Pa}$, particle acceleration from 6.6×10^{-4} to $4.1 \times 10^{-4} \text{ m/s}^2$ peak).

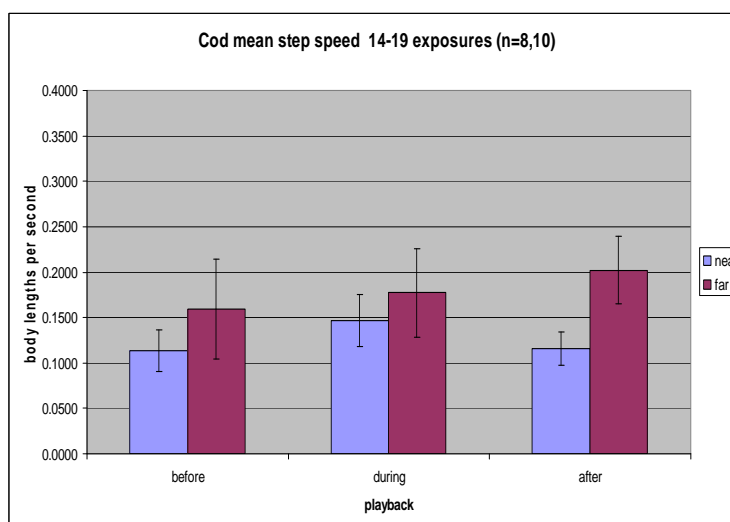
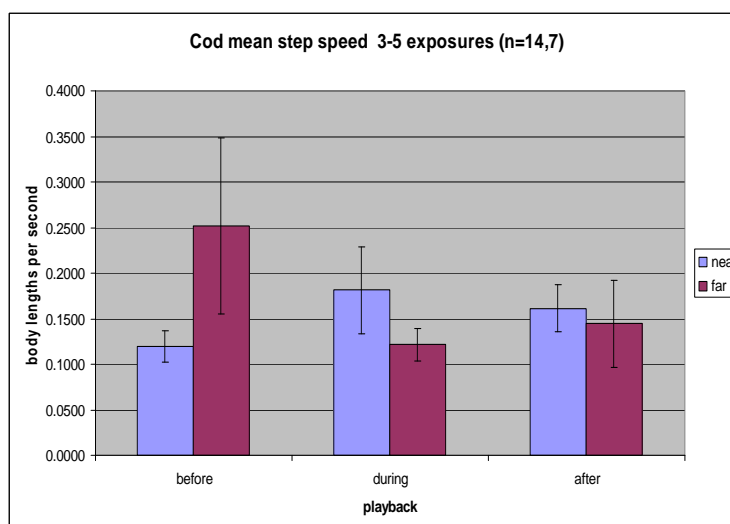
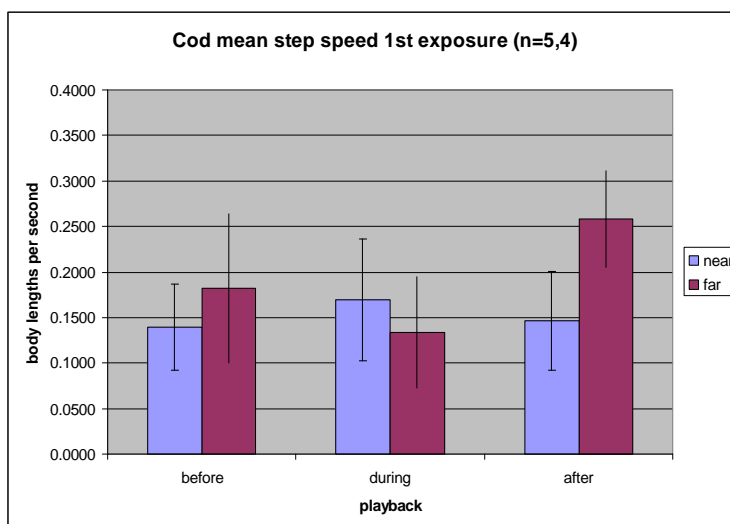

Appendix Figure 9: Mean step speed within the periods of trials in cod exposed to different numbers of playback in the near and far mesocosm.

Sole step direction circular statistics relative to speaker position (0°) in nearest mesocosm to sound source.

Directional response to 1st playback (8 individuals)

Last direction before sound

First direction during sound

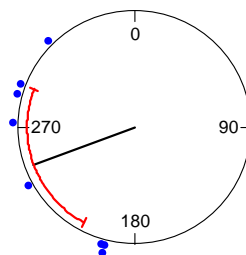
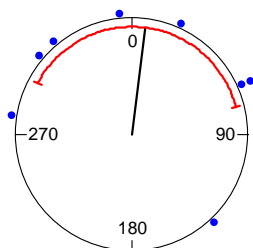

Directional response to 2 – 5 playbacks (14 individuals)

Last direction before sound

First direction during sound

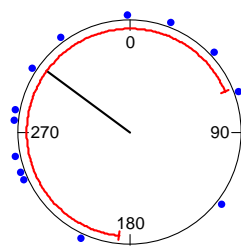
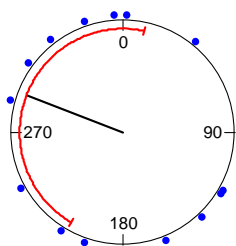

Directional response to 27 – 28 playbacks (3 individuals)

Last direction before sound

First direction during sound

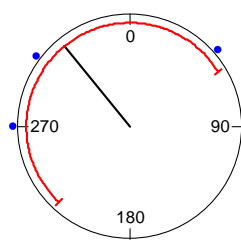
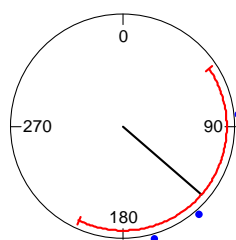

Appendix Figure 10: Directional response of sole to different numbers of playback exposure in the near mesocosm. The loudspeaker is at 0° The sound pressure levels the fish were exposed to reached 144 to 156 dB re 1µPa, the particle acceleration 6.5×10^{-3} to 8.6×10^{-4} m/s² peak.

Sole step direction circular statistics relative to speaker position (0°) in furthest mesocosm to sound source.

Directional response to 1st playback (4 individuals)

Last direction before sound

First direction during sound

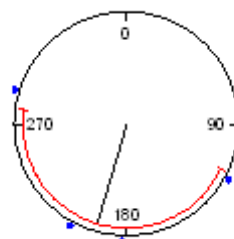
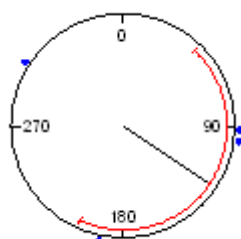

Directional response to 2 – 5 playbacks (8 individuals)

Last direction before sound

First direction during sound

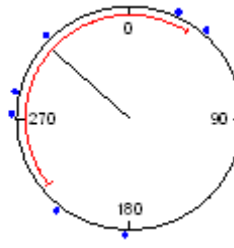
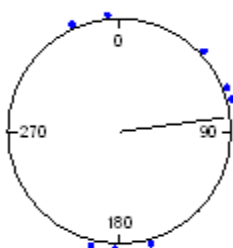

Directional response to 27 – 28 playbacks (3 individuals)

Last direction before sound

First direction during sound

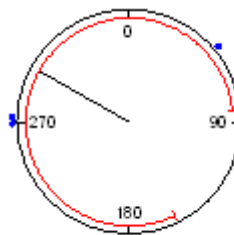
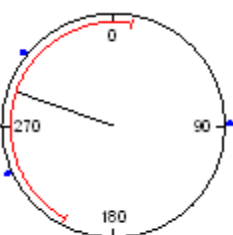

Appendix Figure 11: Directional response of sole to different numbers of playback exposure in the far mesocosm. The loudspeaker is at 0° The sound pressure levels the fish were exposed to reached 132 to 146 dB re 1µPa, the particle acceleration 6.6×10^{-4} to 4.1×10^{-4} m/s² peak.

Cod step direction circular statistics relative to speaker position (0°) in nearest mesocosm to sound source.

Directional response to 1st playback (5 individuals)

Last direction before sound

First direction during sound

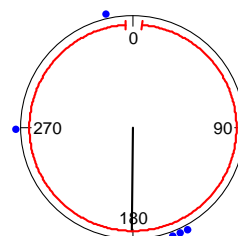
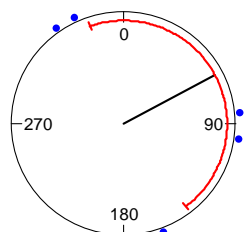

Directional response to 3 - 5 playbacks (14 individuals)

Last direction before sound

First direction during sound

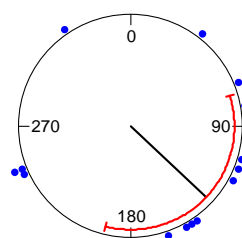
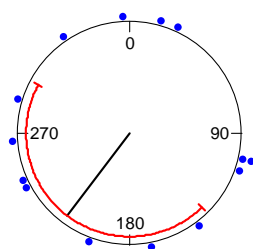

Directional response to 14 – 19 playbacks (8 individuals)

Last direction before sound

First direction during sound

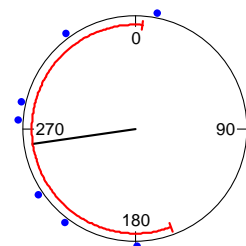
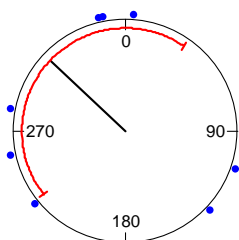

Appendix Figure 12: Directional response of cod to different numbers of playback exposure in the near mesocosm. The loudspeaker is at 0° The sound pressure levels the fish were exposed to reached 140 to 161 dB re 1µPa, the particle acceleration 6.5×10^{-3} to 8.6×10^{-4} m/s² peak.

Cod step direction circular statistics relative to speaker position (0°) in furthest mesocosm to sound source.

Directional response to 1st playback (4 individuals)

Last direction before sound

First direction during sound

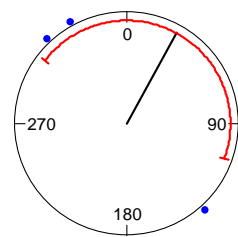
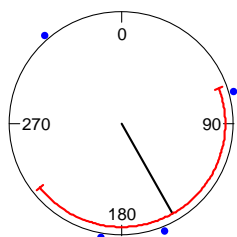

Directional response to 3 - 5 playbacks (7 individuals)

Last direction before sound

First direction during sound

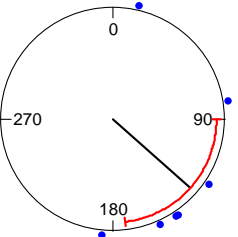
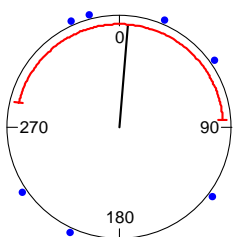

Directional response to 14 – 19 playbacks (10 individuals)

Last direction before sound

First direction during sound

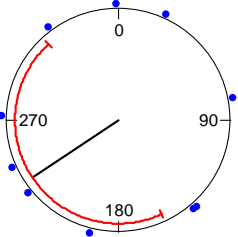
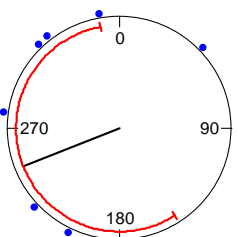

Appendix Figure 13: Directional response of cod to different numbers of playback exposure in the far mesocosm. The loudspeaker is at 0° The sound pressure levels the fish were exposed to reached 133 to 146 dB re 1µPa, the particle acceleration 6.6×10^{-4} to 4.1×10^{-4} m/s² peak.