

COWRIE ENG-01-2007

Assessment and costs of potential engineering solutions for the mitigation of the impacts of underwater noise arising from the construction of offshore windfarms

Georg Nehls, Klaus Betke, Stefan Eckelmann & Martin Ros

September 2007

This report has been commissioned by COWRIE Ltd



© COWRIE Ltd, 2007

Published by COWRIE Ltd.

This publication (excluding the logos) may be re-used free of charge in any format or medium. It may only be re-used accurately and not in a misleading context. The material must be acknowledged as COWRIE Ltd copyright and use of it must give the title of the source publication. Where third party copyright material has been identified, further use of that material requires permission from the copyright holders concerned.

ISBN-13: 978-0-9554279-4-7

ISBN-10: 0-9554279-4-0

Preferred way to cite this report:

Nehls, G., Betke, K., Eckelmann, S. & Ros, M. 2007. Assessment and costs of potential engineering solutions for the mitigation of the impacts of underwater noise arising from the construction of offshore windfarms. BioConsult SH report, Husum, Germany. On behalf of COWRIE Ltd.

Copies available from:

www.offshorewind.co.uk

E-mail: cowrie@offshorewind.co.uk

Contact details:

Georg Nehls, BioConsult SH, Brinckmannstr. 31, 25813 Husum, Germany,
Email: g.nehls@bioconsult-sh.de, Web: www.bioconsult-sh.de

Klaus Betke, ITAP GmbH, Marie-Curie-Str. 8, 26129 Oldenburg, Germany,
Email: betke@itap.de, Web: www.itap.de

Stefan Eckelmann, F+Z Baugesellschaft mbH, Kanalstr. 44, 22085 Hamburg, Germany
Email: stefan.eckelmann@bilfinger.de, Web: www.fz-bau.de

Martin Ros, MENCK GmbH, Am Springmoor, 24568 Kaltenkirchen, Germany
Email: martin.ros@menck.com, Web: www.menck.com

Table of Contents

LIST OF TABLES AND FIGURES	IV
EXECUTIVE SUMMARY	VI
GLOSSARY	VII
ACRONYMS	VII
UNITS.....	VII
1. INTRODUCTION AND SCOPE OF WORK.....	1
2. DEFINING THE PROBLEM.....	2
2.1 PHYSICAL AND TECHNICAL ASPECTS	2
2.1.1 <i>Units and definitions</i>	2
2.1.2 <i>Measurements from offshore construction sites</i>	4
2.1.3 <i>Scaling up of noise emissions with pile dimensions</i>	7
2.2 RESPONSES OF MARINE ANIMALS TO NOISE EMISSIONS.....	10
2.3 SETTING TARGETS FOR NOISE MITIGATION	12
2.3.1 <i>Avoiding physical damage</i>	13
2.3.2 <i>Mitigating disturbance</i>	13
3. METHODS TO REDUCE UNDERWATER NOISE.....	14
3.1 CHARACTERISATION OF THE ACOUSTIC EFFICIENCY.....	14
3.2 MODIFICATION OF THE PILING HAMMER	15
3.2.1 <i>Theory and construction principle</i>	15
3.2.2 <i>Experimental results</i>	17
3.2.3 <i>Possible technical realisation</i>	19
3.3 BUBBLE CURTAIN	20
3.3.1 <i>Theory and construction principle</i>	20
3.3.2 <i>Experimental results</i>	24
3.3.3 <i>Possible technical realisation</i>	28
3.4 PILE SLEEVES	29
3.4.1 <i>Theory and construction principle</i>	29
3.4.2 <i>Experimental results</i>	32
3.4.3 <i>Possible technical realisation A: Inflatable pile sleeve</i>	35
3.4.4 <i>Possible technical realisation B: Telescopic tube</i>	40
3.5 ASSESSMENT AND NEED FOR FURTHER DEVELOPMENT.....	42
4. RECOMMENDATIONS	44
5. REFERENCES.....	46

List of Tables and Figures

Figure 2-1. Typical underwater sound pressure impulse of a pile driving stroke	Page 3
Figure 2-2. Sound spectra of a pile stroke, measured with different bandwidths	4
Figure 2-3. Spectra for some of the of pile driving operations listed in Table 2-1	6
Figure 2-4. Lower limiting frequency of propagation as a function of water depth	7
Figure 2-5. Noise level as a function of blow energy	8
Figure 2-6. Underwater noise measurement at FINO2	8
Figure 2-7. Peak and SEL levels as a function of pile diameter	9
Figure 2-8. Hearing thresholds of marine mammals and noise from pile driving	11
Figure 3-1. Two hypothetical mitigation measures with different frequency characteristics ..	15
Figure 3-2. Simplified model of hammering	15
Figure 3-3. Spectra of rectangular impulses of different lengths	16
Figure 3-4. Relative stroke force, measured with sensors on the pile	17
Figure 3-5. Peak levels with a steel cable as a "cushion" between hammer and pile	17
Figure 3-6. Third octave spectra from different phases of the steel cable experiment	18
Figure 3-7. Spectra of a single-acting double-acting pile drivers	18
Figure 3-8. Backscattering length of a gas bubble in water	20
Figure 3-9. Resonance frequency of an air bubble in water as a function of diameter	21
Figure 3-10. Sound attenuation after equation 3.1 for various bubble sizes	22
Figure 3-11. Rise velocity of air bubbles in water	23
Figure 3-12. Bubble drift due to current and confined bubble curtain	24
Figure 3-13. Bubble curtain setup by Würsig et al.	24
Figure 3-14. Bubble curtain ring and confined bubble curtain	25
Figure 3-15. Two-ring bubble curtain system	25
Figure 3-16. Test setup by Vagle	26
Figure 3-17. Bubble curtain system with three stacked rings	26
Figure 3-18. Sound attenuation versus frequency for some bubble curtains	27
Figure 3-19. Confined bubble curtain; construction sketch	28
Figure 3-20. Sound wave encountering an impedance change	29
Figure 3-21. Sound wave passing through a layer with different impedance	30
Figure 3-22. Sound level reduction obtained with layers containing air	31
Figure 3-23. Level reduction with imperfect sound absorption inside the pile sleeve	31
Figure 3-24. Pile sleeve test setup	32
Figure 3-25. Foam-coated steel tube in measurement position	33
Figure 3-26. Pile sleeve made of 5 mm rubber	33
Figure 3-27. Results of the pile sleeve experiment	34
Figure 3-28. Double-wall pile sleeve model	34
Figure 3-29. Results of double-wall pile sleeve experiment	35

Figure 3-30. Inflatable noise mitigation system, side view	37
Figure 3-31. Pile guiding frame with winches. Angular guiding frame	38
Figure 3-32. Pile guiding frame with winches. Half-round guiding frame	38
Figure 3-33. Top view of hose curtain	39
Figure 3-34. Telescopic pile sleeve	40
Table 2-1. Underwater peak levels and SELs measured during pile driving works	5
Table 2-2. Hammer sizes suggested by a pile driver manufacturer	9
Table 2-3. Predicted level increment for increase of pile diameter from 4 m to 6.5 m	10
Table 2-4. Predicted underwater noise levels for driving large piles	10
Table 3-1. Results from bubble curtain operations	27
Table 3-2. Predicted sound levels with and without mitigation.....	43

Executive Summary

This report reviews the possibilities to mitigate the noise arising from pile driving for the construction of offshore windfarms. It analyses mitigation measures which have been applied in related projects and assesses their applicability to offshore pile driving. Based on this, suggestions for new mitigation measures are made. The report identifies two methods which are promising to be both applicable and effective in reducing underwater noise arising from offshore pile driving. Both methods are considered to be generally compatible to the working processes at sea. Although further engineering work would be needed, they could be brought into practice within a few months.

Based on measurements of offshore pile driving, noise emissions of large piles are estimated to reach peak levels of 201-205 dB re 1 μ Pa and sound exposure levels SEL of 175-178 dB re 1 μ Pa at a distance of 500 m. Noise produced from offshore pile driving may be harmful and disturbing to marine wildlife. From literature data it is inferred, that physical impairment may occur above levels (SEL) of 180 dB re 1 μ Pa. As a first proxy for disturbance of marine mammals, the report refers to a level of 140 dB re 1 μ Pa.

Mitigation measures have so far mainly focussed on bubble curtains, which are made up from air bubbles released at the seafloor around a source of noise. Bubble curtains may efficiently reduce underwater noise but it is considered to be impossible to install bubble curtains in the offshore environment at great water depths and tidal currents. The main reason for this is the slow ascent rate of the bubbles resulting in large installation accounting for currents and water depths.

Attempts to mitigate noise from pile driving by prolonging the duration of the blows of the piling procedure through modification of the pile driver were rejected at this stage. As a prolongation of the blows may result in a loss of piling energy this may impair the success of the piling. However, further research on this method is recommended.

Two new methods are described in detail which are considered to be effective and practicable to construct a permanent noise barrier around the piles made up from foam or air: First, an inflatable piling sleeve which can be permanently mounted below the piling gate at the construction platform. The sleeve is meant to be released after insertion of the pile into the piling gate and inflated to a 50 mm layer of air during the piling operation. The sleeve is expected to reach an attenuation of 20 dB broadband. Second, a telescopic double-wall steel tube with an interspace filled with foam. The tube is constructed in several segments to reduce the height when released on the seafloor underneath the piling gate. The pile is inserted into the tube which is lifted to full length during the piling operation. A 100 mm foam layer is calculated to reach an attenuation of 15 dB broadband. Both methods are considered to be compatible to the piling process and costs are roughly estimated to reach about 20,000 € per pile in the inflatable sleeve and about 25,000 € per pile in the telescopic tube. The construction of the telescopic tube are lower than in the inflatable sleeve but overall costs are expected to be higher as handling at sea demands some extra time of the construction process. In this respect, there appears to be an advantage of the inflatable sleeve which would result in very little interference in the piling process. The attenuation from these methods is considered to be high enough to achieve a substantial reduction of the impacts on marine wildlife. Calculated radii of physical damage may be reduced by more than 90 % and radii of disturbance by two-third.

Suggestions for further investigations and towards the development of a programme for reducing underwater noise from pile driving are presented.

It is concluded, that noise mitigation measures offer good opportunities to reduce the impacts of underwater noise arising from the construction of offshore windfarms. For the offshore industry, noise mitigation may prove to be beneficial as their application may allow construction works in areas and times when restrictions are needed to protect sensitive species.

Glossary

Hammer	Synonym for pile driver
Monopile	Construction principle for offshore wind turbines or other offshore buildings. The turbine is erected on a single pile rather than e.g. on a tripod
Pile	Steel tube of several metres diameter used as a foundation for wind turbines and other offshore structures
Pile driver	Device used to drive piles into the sediment to provide foundation support for buildings or other structures. In this study, the term is used for impulse pile drivers only, not for e.g. vibration pile drivers

Acronyms

FINO	<i>Forschungsplattformen in Nord- und Ostsee</i> = Research Platforms in the North and Baltic Seas. Measurement platforms in German waters funded by the Federal Ministry for the Environment (BMU)
PSD	<i>Power Spectrum Density</i> . Sound spectrum, i.e. a representation of sound level versus frequency, where the "bin width" of the spectral values is 1 Hz. See section 2.1.1 for details
PTS	<i>Permanent Threshold Shift</i> . Permanent hearing damage caused by very intensive noise or by prolonged exposure to noise
SEL	<i>Sound Exposure Level</i> . Sound level of a single sound event averaged in a way as if the event duration was 1 s. Used here for comparing sound levels of pile strokes, independent of the number of strokes per minute
TTS	<i>Temporary Threshold Shift</i> . Temporary reduction of hearing capability caused by exposure to noise

Units

dB	<i>Decibel</i> . Unit to express the magnitude of physical quantities that vary over a large range; mainly used in electronics and in acoustics. The magnitude is described relative to a reference value. Often the resulting dB number is called <i>level</i> . Example: The sound level in dB is $20 \log_{10}(p/p_0)$, where p is the actual sound pressure and p_0 the reference pressure, which by international agreement is $1 \mu\text{Pa}$ for underwater sound
Hz	<i>Hertz</i> . Frequency unit. 1 Hz means 1 cycle per second. In acoustics often used with prefix "k" (kilo): 1 kHz = 1000 Hz
kg	<i>Kilogram</i> . Mass unit. 1 kg = 2.2046 pounds
J	<i>Joule</i> . Energy Unit. Used in this report to specify the impact energy of a pile driver. Large pile drivers reach values of more than 1000 kJ
kg/m ³	<i>Kilogram per cubic metre</i> . Density unit. Example: Water has a density of approximately 1000 kg/m ³
m	<i>Metre</i> . Length unit. 1 m = 3.2808 ft = 39.37 inches. Example: 10 mm (millimetre) = 1 cm (centimetre) = 0.3937 inches
m/s	<i>Metre per second</i> . Velocity unit. Example: The speed of sound in water is approximately 1500 m/s
Pa	<i>Pascal</i> . Pressure unit. 1 Pa = 10^{-5} bar = 145.04×10^{-6} psi. Used also in acoustics to describe sound pressure. A tone with a sound pressure of 1 Pa means that the

pressure in the medium (e.g. water or air) oscillates by $\pm 1 \text{ Pa}$ around the mean ambient pressure

ton

Mass unit. 1 metric ton = 1000 kg = 2204.6 pounds

1. Introduction and scope of work

As offshore wind farming makes progress in Europe, there is concern that the installation of offshore turbines may also have adverse effects on marine wildlife (Madsen et al. 2006, Thomsen et al. 2006). Most offshore turbines in European waters are based on monopile foundations. This means, that large steel piles with a diameter of at present 2 to 4.5 metres and a weight of up to 400 tons are driven into the seabed using large hydraulic piling hammers. The noise emitted into the sea is considered to be harmful and disturbing to marine mammals and fish. Dolphins and porpoises rely primarily on echolocation for orientation and food search, thus underwater noise may be harmful (if not lethal) to these protected animals and may impair their feeding abilities as well as their social communication. The noise emitted by construction work of large monopile foundation may possibly cause physical damage to both marine mammals and fish in the vicinity and disturbance in the larger surroundings. However, although much work on zones of physical damage (e.g. Ketten & Finneran 2004, Southall *et al.* 2007), as well as on behavioural responses (Kastelein *et al.* 2005, Kastelein *et al.* 2006, Lucke *et al.* 2007) has been done in the last years, many uncertainties about the effects of noise from underwater pile driving remain especially concerning the displacement of marine mammals from their native habitats. Noise emissions increase with growing size of the foundations as well as with increasing water depths. Thus, the tendency in offshore wind farming towards larger turbines, greater distances to the shore and consequently greater water depths may increase noise emissions and the adverse effects on marine wildlife.

As a consequence, noise mitigation measures are sought in order to reduce sound pressure below values harmful to marine mammals and fish. Sound propagation can be reduced by barriers of a medium that differs in density from the main sound transporting medium. In a dense and nearly incompressible medium such as water, a barrier would most efficiently consist of a highly compressible medium of low density. Consequently, in all attempts to mitigate underwater noise, air barriers have been constructed around the noise sources. So-called "bubble curtains" have been in use for a long time in order to prevent underwater structures from damage and also first attempts to protect marine mammals have brought bubble curtains into practice (e.g. Würsig et al. 2000). Bubble curtains are created by releasing air at the bottom of the seabed so that a "wall" of bubbles rises to the water surface between the noise source and the object to be protected. In order to cope with larger structures and ocean/sea currents, several techniques as bubbler manifold releasers and confined bubble curtains have been developed to provide a closed curtain around the source of noise emissions. Recent research has been directed towards the development of fixed barriers such as coated tubes and towards modification of the piling hammer (Schultz von Glahn *et al.* 2006, Elmer *et al.* 2007). However, the inevitable questions towards all noise mitigation measures are, whether they are applicable to large piles, greater water depths and harsh offshore conditions.

In order to assess the efficacy of existing options to reduce underwater noise emitted from pile driving activities, COWRIE has commissioned BioConsult SH, ITAP, MENCK and F+Z to carry out a desk-based study with the following aims:

- Assess the efficacy of existing, "off the shelf", engineering solutions in reducing underwater noise from pile driving activities in the marine environment.

- Research bespoke engineering approaches to reducing such underwater noise levels.

- Evaluate the cost of such approaches.

- Identify shortcomings/ strengths of the existing methods and make recommendations for further research or work. Such further work might include the commissioning of designs or solutions from manufacturers.

- Considering the availability, cost and effectiveness of available techniques, make recommendations for a programme for reducing underwater noise from pile driving activities at offshore windfarms and, if possible, deliver a methodology for such a programme capable of commercial implementation.

The aim of the study is to analyse existing noise mitigation methods according to their efficacy and applicability in offshore construction work and to recommend an engineering solution for offshore windfarm constructions with special emphasis on larger structures and greater water depths.

In this report we will give an analysis of noise emissions from underwater construction works and a first evaluation of noise mitigation methods. Based on this analysis, a selection of noise mitigation methods will be made. The selected methods will be analysed in detail regarding their costs, their implementation in the construction process of monopiles at sea and their efficacy with respect to the protection of marine wildlife.

2. Defining the problem

2.1 Physical and technical aspects

2.1.1 Units and definitions

In sound engineering, the "strength" of a sound is specified by its *level* in decibels (dB). However, a single dB value is not always a sufficient characterisation. In particular this is the case for impulsive sounds like pile driving strokes. Useful values are:

- Equivalent continuous sound pressure level
- Sound exposure level (SEL)
- Peak level

These parameters, as well as some problems concerning frequency spectra, are discussed below.

Equivalent continuous sound pressure level. This is probably the most common quantity in noise control. It is also called time-averaged level. Usually it is abbreviated L_{eq} and is defined as

$$L_{eq} = 10 \log \left(\frac{1}{T} \int_0^T \frac{p(t)^2}{p_0^2} dt \right) \text{ dB} \quad (2.1)$$

where $p(t)$ is the sound pressure, p_0 the reference pressure of 1 μPa and T the averaging time. As a numerical recipe, equation 2.1 reads "square observed sound pressure values, average them (i.e. multiply each p^2 by time step dt , add up all products and divide sum by T), divide by p_0^2 and apply 10 log to obtain result in dB."

Sound exposure level. It is obvious that for non-continuous sound like pile driving impulses, the L_{eq} not only depends on the averaging time and on the intensity of the impulses, but also on the intervals in between them. Hence a better suitable quantity for comparing noise from pile drivers is the sound exposure level or SEL. In this report, the symbol L_E is used for the SEL. It is defined slightly different from the L_{eq} :

$$L_E = 10 \log \left(\frac{1}{T_0} \int_{T_1}^{T_2} \frac{p(t)^2}{p_0^2} dt \right) \quad (2.2)$$

The averaging start and stop times T_1 and T_2 are chosen arbitrarily, but in a way that the sound event lies in between T_1 and T_2 , see Figure 2-1. T_0 is 1 second. That is, the *SEL is the level of a continuous sound with 1 s duration and the same sound energy as the impulse*. It equals the "energy level" (in dB re 1 $\mu\text{Pa}^2\text{s}$) sometimes found in literature. The L_E is more difficult to measure directly than the L_{eq} , but there is a simple relationship between the two quantities:

$$L_E = L_{eq} - 10 \log \frac{nT_0}{T} \quad (2.3)$$

where n is the number of events (e.g. pile strokes) within the observation time T . As above, $T_0 = 1$ s. Applying equation 2.3 to an L_{eq} measurement yields the average L_E of n events. Note: The SEL function implemented in sound level meters works according to equation 2.3, but with a fixed value of $n = 1$.

Peak level. Impulsive sounds can have moderate L_{eq} or L_E values, but very high instantaneous pressure peaks though, which might be harmful to the auditory system. A measure for these is the peak level. Contrary to L_{eq} and L_E , there is no averaging:

$$L_{peak} = 20 \log (|p_{peak}| / p_0) \quad (2.4)$$

where p_{peak} is the highest observed sound pressure (may also be the most negative). An example is shown in Figure 2-1.

Some authors prefer the *peak-to-peak level*, which considers not only the highest absolute peak, but both minimum and maximum sound pressure. It is a relatively uncommon value in sound engineering. At some distance from an underwater sound source, after the signal has been reflected several times at the sea bottom and the sea surface, the magnitudes of the positive and negative maximum are almost equal. Thus

$$L_{peak-to-peak} = L_{peak} + 6 \text{ dB} \quad (2.5)$$

is an adequate approximation for converting between peak levels and peak-to-peak levels. In the example in Figure 2-1, the difference between them is 5.8 dB.

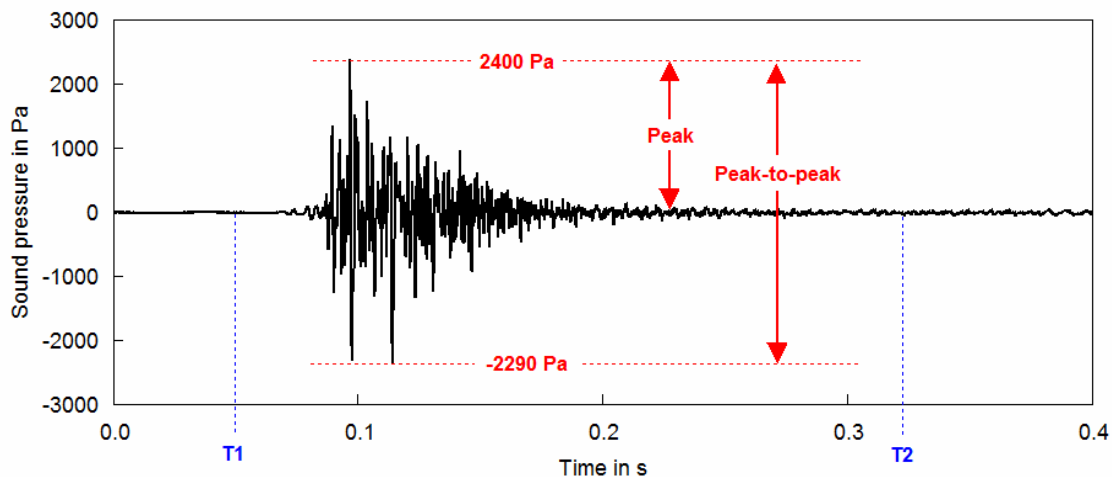

Fig. 2-1. Typical underwater sound pressure impulse of a pile driving stroke in several hundred metres distance. T_1 and T_2 are explained in the definition of the sound exposure level, see equation 2.2. The peak level in this example is $20 \log(2400/10^{-6})$ dB = 187.6 dB, whereas the peak-to-peak level is $20 \log((2400+2290)/10^{-6})$ dB = 193.4 dB.

Spectra. So far only broadband values have been considered, but the distribution of sound energy along the frequency axis is of interest as well. In principle, a spectrum is produced by feeding the sound signal through a number of adjacent filters and computing the L_{eq} or L_E level at each filter output. One difficulty with spectra is that the resulting levels depend on the frequency resolution of the analysis. Figure 2-2 shows some examples. Although the levels differ considerably, none of the curves is "wrong"; the wider the filters, the more sound energy is gathered in each of them and the higher the levels.

In order to avoid these difficulties, often a standardized bandwidth of 1 Hz is used. The result is called *power spectrum density (PSD)* or *spectral level*. Formally, levels in a given spectrum with Bandwidth B_1 can be converted to Bandwidth B_2 (e.g. $B_2 = 1$ Hz) by

$$L_{B_2} = L_{B_1} + 10 \log (B_2/B_1) \quad (2.6)$$

Spectral levels, however, are only meaningful for "continuous", "smooth" spectra (Urick 1983, p.14), like underwater ambient noise for example. Narrow peaks in the spectrum by contrast cause problems, since their "true" and thus biologically relevant levels are adulterated by the normalisation to 1 Hz bandwidth. The difficulties are much less pronounced with third octave spectra (the bandwidth of a third octave spectrum is not constant, but approximately $f/4$, where f is the band centre frequency. Standardised centre frequencies are 1 Hz, 1.25, 1.6, 2, 2.5, 3.15, 4, 5, 6.3, 8, 10, 12.5, and so on).

Furthermore, spectral levels cannot be compared with hearing thresholds, because they do not fit the auditory system's bandwidth for loudness integration (the so-called critical bands). It is unknown for most species, but one third octave appears to be a realistic approach at least for marine mammals (Thomsen *et al.* 2006). For these reasons, third octave spectra are preferred by the authors wherever possible. A frequency resolution of a third octave is also adequate for the issue of this study.

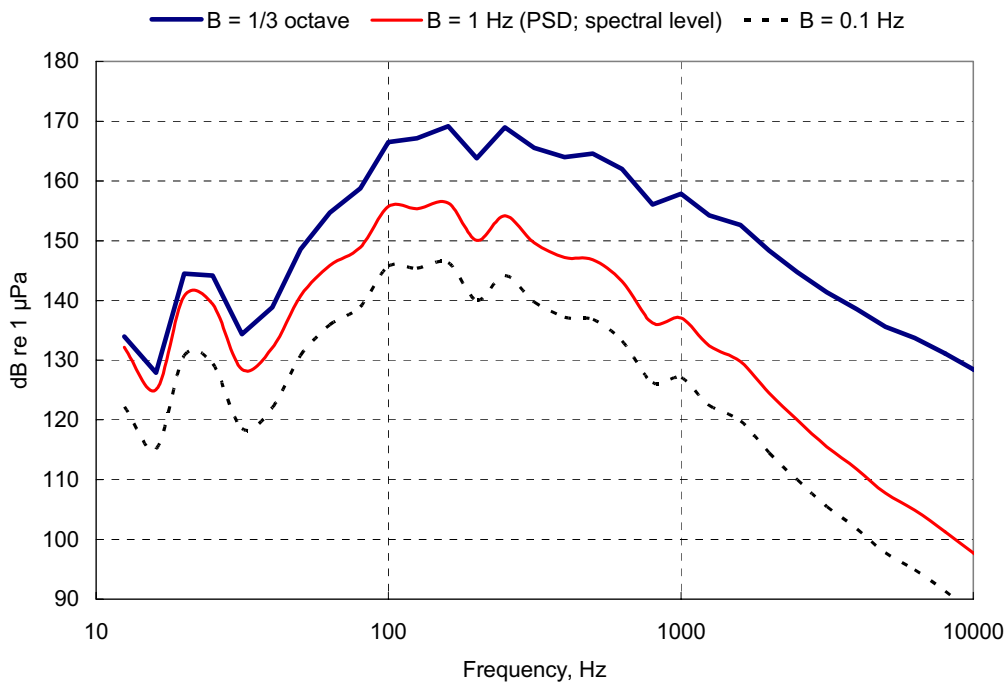

Fig. 2-2. Spectra of sound exposure level (SEL) of a pile stroke, measured with different bandwidths

2.1.2 Measurements from offshore construction sites

Table 2-1 lists several measurements of underwater sound during offshore pile driving works. Figure 2-3 shows the respective sound spectra of four cases. Highest sound pressures are reached in low frequencies from 100 to 300 Hz, with the exception of the port constructions, where the maximum is near 400 Hz for unknown reasons. Similarly, sound spectra from North Hoyle construction works peaked around 200 Hz (Nedwell *et al.* 2003).

Table 2-1. Underwater peak levels and SELs measured during pile driving works, ordered by pile diameter. Normalised values in column 9 and 10 were computed according to $L_{norm} = L_{measured} + 10 \log(20/H) + 15 \log(R/500)$, where H is the actual depth and R the measurement distance.

Project	2 Pile diameter, m	3 Water depth, m	4 Measuring depth, m	5 Measuring distance, m	6 Blow energy, kJ	7 Peak level, dB re 1 µPa	8 SEL, dB re 1 µPa	9 Peak level normalised to 500 m distance and 20 m depth, dB re 1 µPa	10 SEL normalised to 500 m distance and 20 m depth, dB re 1 µPa	11 Remarks
Jade port construction works, Germany, 2005	0.9	11	5	200	70-200	188	162	187	161	1
Jade port construction works, Germany, 2005	1.0	11	5	340	70-200	190	164	190	164	2
FINO 1, Germany, 2003	1.6	30	10	750	80-200	192	162	191	161	3, 4
SKY 2000, Germany, 2002	3.0	21	5	260	200	?	170	n/a	165	3, 4
FINO 2, Germany, 2006	3.3	24	5	530	300	190	170	188	168	1, 4
Amrumbank West, Germany, 2005	3.5	23	10	850	550	196	174	198	176	1, 4
North Hoyle, UK, 2003	4.0	7-11	5	955	450	192	155?	199	162?	5, 9
Scroby Sands, UK, 2003	4.2	1-8	<5	500	?	194	?	199	?	6, 9
Kentish Flats, UK, 2005	4.3	3	2	243	400	189	?	193	?	7, 9
Barrow, UK, 2005	4.7	15-20	5?	500	?	198	?	199	?	7, 9
Burbo Bank, UK, 2006	4.7	<10	5?	500	?	190	?	193	?	8, 9

Remarks: 1. ISD *et al.* 2007 – 2. ITAP, unpublished data – 3. CRI *et al.* 2004 – 4. Research or measurement platform – 5. Nedwell *et al.* 2003. SEL not reported, but extracted graphically from figure 21 and adjusted for blow rate of 35/minute – 6. Nedwell *et al.* 2003. Data read from figure 33 – 7. Parvin *et al.* 2006a – 8. Parvin *et al.* 2006b – 9. Peak levels calculated from reported peak-to-peak values by subtracting 6 dB

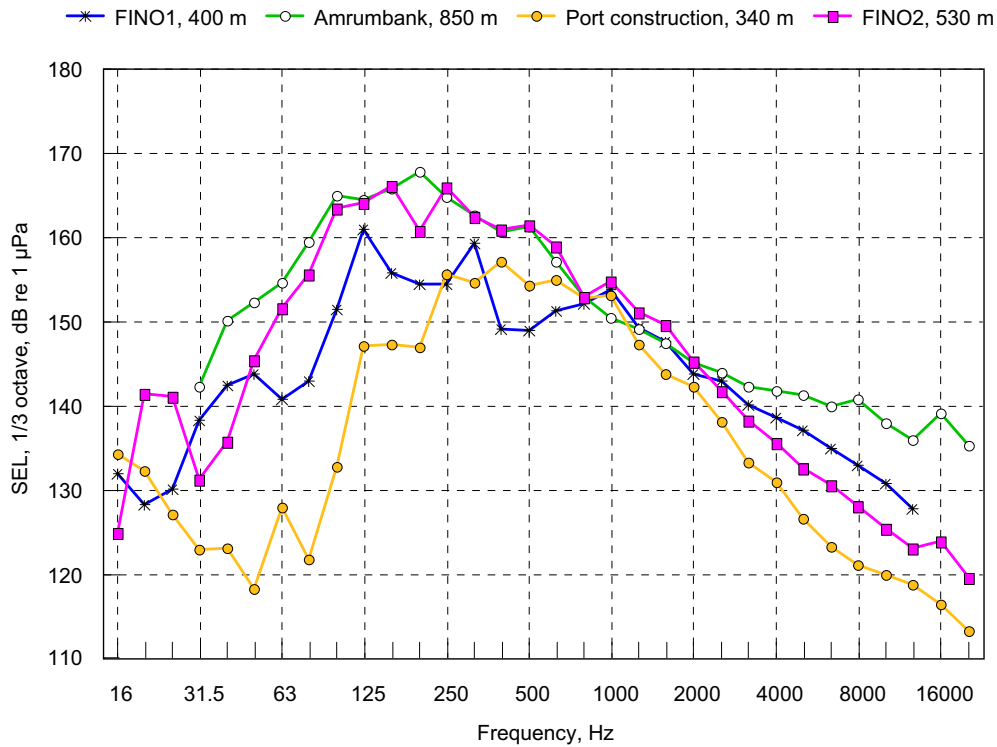

Fig. 2-3. Spectra for some of the of pile driving operations listed in Table 2-1

Normalisation to standard distance. Data from Table 2-1 were obtained from measurements at different water depths and at different distances to the source. For better comparability, values were normalised at a distance of 500 m and a water depth of 10 m:

$$L_{500m} = L_{measured} + 10 \log(20/H) + 15 \log(R/500) \quad (3.1)$$

These values are listed in columns 9 and 10 in Table 2-1. The presumed relation of noise level and distance to the source of $15 \log(R)$ is based on measurements in the North Sea and the Baltic Sea at about 2500 m distance (ISD *et al.* 2006).

A considerably stronger attenuation up $30 \log(R)$, as published by Nedwell *et al.* (2003) and Parvin *et al.* (2006a) probably results from lower depths of the respective measurements. In shallow water, sound at lower frequencies is much more attenuated than expected from geometric transmission loss and sound propagation is only possible above a certain frequency. According to Urick (1983, p. 175) the lower limiting frequency can be calculated by the following formula:

$$f_0 = \frac{c_{water}}{4h} \sqrt{\frac{1}{1 - (c_{water} / c_{bottom})^2}} \quad (3.2)$$

In this equation, h is the water depth, c_{water} and c_{bottom} are the sound velocities in water and in the sediment. Sound velocity in water c_{water} is approx. 1500 m/s and c_{bottom} usually somewhat larger. The lower limiting frequency in shallow water <10 m may well lie below the sound maximum of piling work (Figure 2-4). Attenuation of noise emitted from piling will be higher than average in shallow waters.

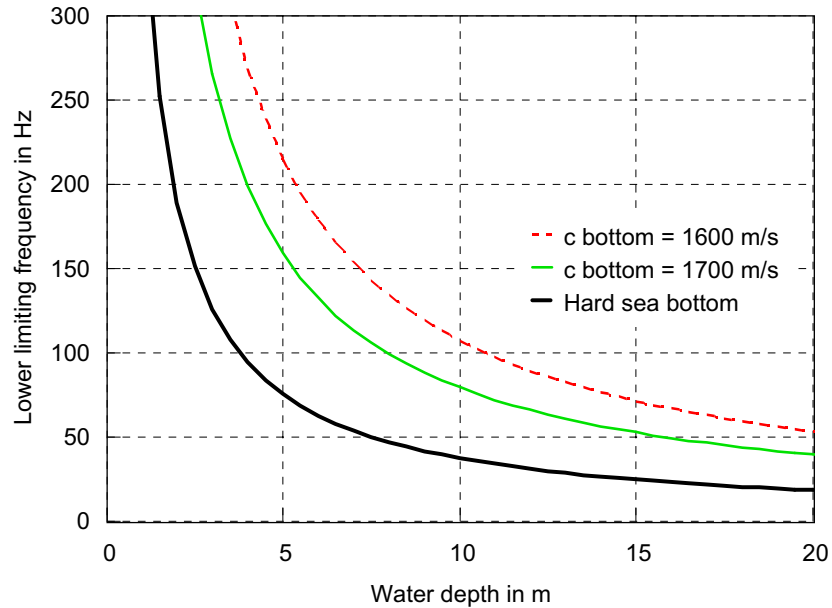

Fig. 2-4. Lower limiting frequency of propagation as a function of water depth, after equation 2.8. Sound below this frequency is attenuated much stronger than the maximum geometric transmission loss $20 \log(R)$.

As a consequence of the difficulties to obtain precise values on sound propagation in different water depths, we will not refer to the source level calculated from measurements in greater distance but calculate all values to a standard of 500 m from source. The error in transferring values from distances of 250 m or 1000 m to 500 m will be little affected by differing assumptions on noise propagation whereas an extrapolation to a distance of 1 m at source may differ in the order of several 10 dB.

2.1.3 Scaling up of noise emissions with pile dimensions

The amount of sound emitted from a tube or pile depends on the size of the radiating surface and on the vibration amplitude of this surface. When the pile diameter increases, the radiating surface increases, but as long as the pile driver energy is not raised, the amplitude decreases, since the available exciting force now has to excite a larger number of surface elements. Hence a larger diameter alone does not necessarily lead to an increase of noise. However, the force on the pile increases, because a larger pile causes a stronger friction force in the sediment, and this effect causes a somewhat higher sound level, but this part of the radiated sound is difficult to estimate.

A simple but physically reasonable assumption is that noise emissions are proportional to blow energy. Expressed in dB this means that the noise level increases by $10 \log(E_2/E_1)$ if the blow energy is increased from E_1 to E_2 .

Unfortunately there are few measurements of the relation of blow energy and noise emission. Experiments by Schultz-von Glahn *et al.* (2006) indicated a somewhat steeper increase of about $13 \log(E_2/E_1)$ for frequencies from 100 Hz to 1000 Hz, which is the range of the highest emissions in pile driving. At higher frequencies, there is a steeper increase of noise emissions in relation to blow energy (Fig. 2-5). A further measurement is shown in Figure 2-6. The observed level increase of 1 dB after a raise of blow energy from 250 kJ to 300 kJ is also in accordance with $13 \log(E_2/E_1)$.

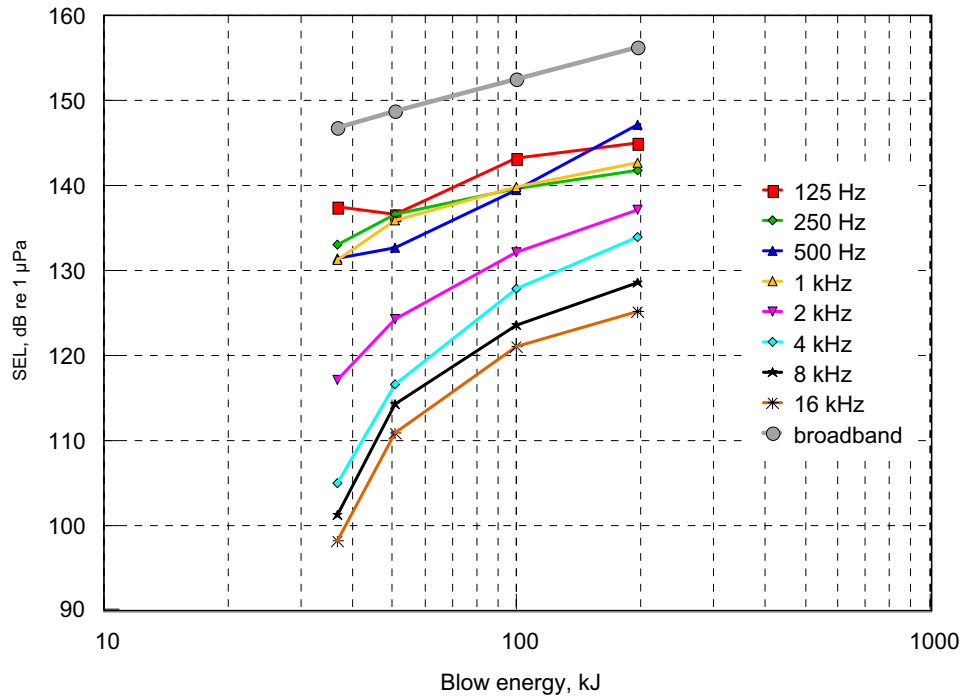

Fig. 2-5. Underwater level as a function of blow energy, produced by a drop hammer (MENCK MHF 10-20) on a 2.2 m pile in 500 m distance. Energies were 37 kJ (minimum setting for this pile driver), 50 kJ, 100 kJ and 200 kJ (Schultz-von Glahn *et al.* 2006).

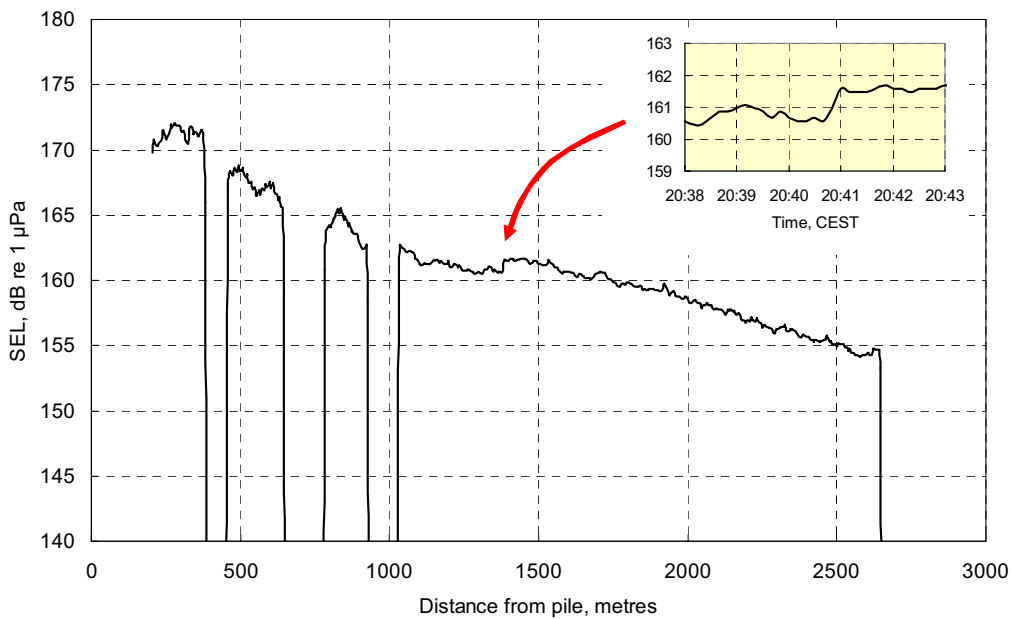

Fig. 2-6. Underwater noise measurement at FINO2 (see Table 2.1) while drifting away from the construction site with a speed of about 0.5 m/s. At 20:41, the blow energy was raised from 250 kJ to 300 kJ, causing a level increase of about 1 dB. The pile driver was an IHC S-500 hydraulic hammer (ISD *et al.* 2007).

There is no rule of thumb for the required pile driving energy as a function of pile diameter. Beside the pile diameter, the sediment properties are crucial. A further criterion is mechanical fatigue. At maximum blow energy, the wear of a pile driver is high. It can be more economical to utilise a large pile driver and operate it to only 2/3 of its maximum power. Furthermore, fatigue due to the pile driving process has significant impact on the pile's lifetime. The pile is

less stressed if, for example, 600 kJ blows are applied with a 1900 kJ hammer rather than with an 800 kJ hammer. This is due to the lower impact velocity of the larger hammer. Pile driver sizes suggested by MENCK are listed in Table 2-2.

An over-dimensioned pile driver also produces less noise due to the lower impact velocity. The principle is similar to a drop hammer. A measurement with a drop hammer is shown in Section 3 of this report.

Table 2-2. Hammer sizes suggested by a pile driver manufacturer

Pile diameter	Suggested pile driver (maximum blow energy)
Up to 4.5 m	550 kJ
Up to 5.2 m	800 kJ
4.7 m to 6.5 m	1900 kJ

In order to estimate how the different factors lead to a relation between pile dimension and noise emission, Figure 2-7 computes the available data of pile size and noise emissions both as peak level and as SEL level. The slope of the regression based on SEL levels is 2.3 dB/m and thus a little lower than the value of 2.4 dB/m for the peak level, however, sample size is rather small. Assuming a quadratic relation of pile diameter on noise emission of $40 \log(D2/D1)$, Parvin *et al.* (2006a) calculate the level increase from 4 to 6.5 m diameter. Although the approaches are different, the results are rather similar (Table 2-3).

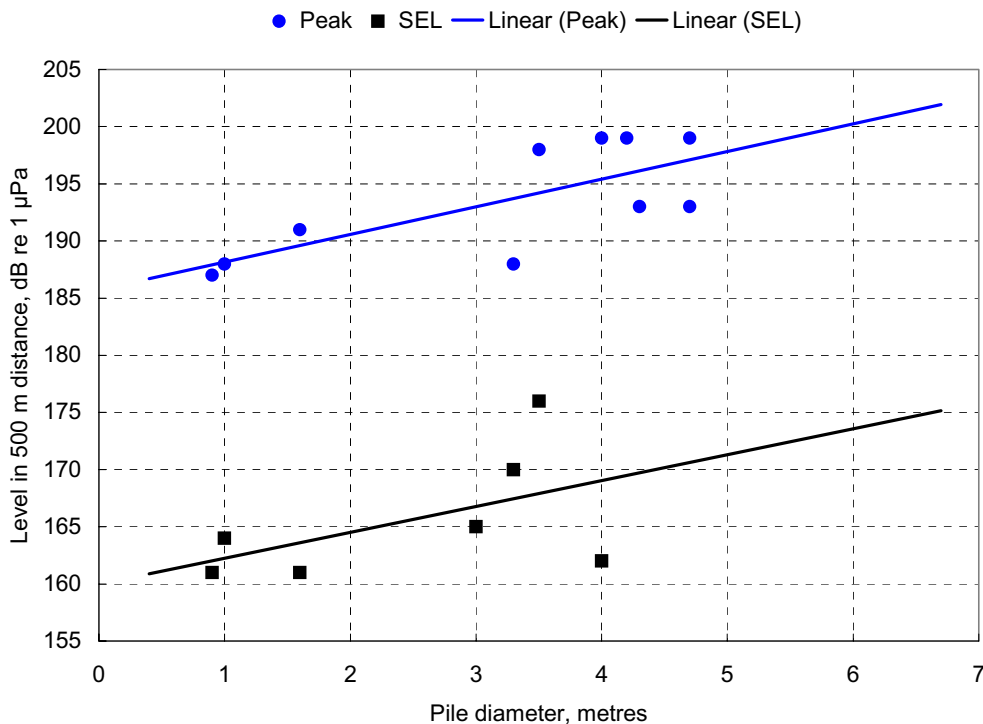

Fig. 2-7. Peak and SEL levels from Table 2.1 as a function of pile diameter

Table 2-3. Predicted level increment for increase of pile diameter from 4 m to 6.5 m

Approach	Increase of broadband level when increasing pile diameter from 4 m to 6.5 m
Parvin <i>et al.</i> (2006a), sound pressure $\sim D^2$	8.4 dB
Regression for peak level from Figure 2-7	6.0 dB
$L_2 = L_1 + 13 \log(E_2/E_1)$ and increase of blow energy from $E_1 = 400$ kJ to $E_2 = 1200$ kJ	6.2 dB

Finally, based on data from Figure 2-7, noise emissions of a pile with a diameter of 6.5 m are estimated (Table 2-4). The higher values in Table 2-4 refer to the calculation of Parvin *et al.* (2006a), the lower value to calculations with our own data. It has to be mentioned that due to a number of uncertainties, the values may vary by ± 5 dB.

Table 2-4. Predicted underwater noise levels for driving large piles

Quantity	Level in 500 m distance for a 6.5 m pile in 20 m deep water
Peak level	201-204 dB re 1 μ Pa
Sound exposure level (SEL)	175-178 dB re 1 μ Pa

2.2 Responses of marine animals to noise emissions

About 9 whale and dolphin and 2 seal species regularly occur in British waters and can be expected within the round 2 windfarm areas (BMT Cordah 2003):

- Harbour porpoise
- Bottlenose dolphin
- Common dolphin
- Risso's dolphin
- White-beaked dolphin
- Striped dolphin
- Atlantic white-sided dolphin
- Minke whale
- Cuvier's beaked whale
- Grey seal
- Harbour seal

The most abundant species are the harbour porpoise and the harbour seal and these species are often taken into focus when evaluating the impacts of anthropogenic noise on marine mammals.

Hearing of marine animals and their use of sound is well adapted to the physical properties in their environment. Sound plays a vital role for marine mammals. Their hearing is highly specialised to receive information on their environment, predators and prey. They communicate acoustically, and odontocetes (Toothed whales) even echolocate using ultrasound clicks (Evans 1998). Fishes use hearing for acoustic communication, the detection of predators and prey, and also to learn about their acoustic scene (reviewed in Popper *et al.* 2003). Sound production and vocal communication is widespread among teleost fish species (reviewed in Zelick *et al.* 1999). Other biotic taxa also respond to marine noise, but existing knowledge is poor compared to that concerning marine mammals and fishes.

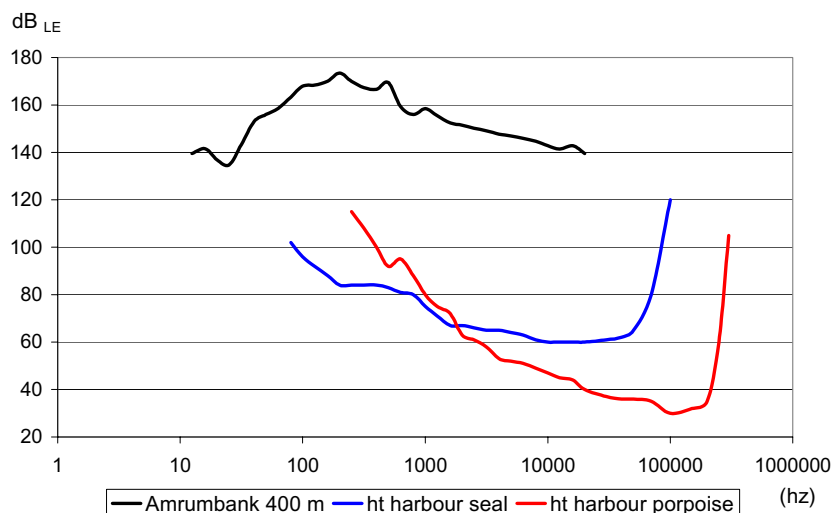

Fig. 2.8. Hearing thresholds of harbour porpoise and harbour seal and noise from underwater pile driving. Sources: Noise emissions (SEL) from pile driving at Amrumbank (North Sea, Germany) (ISD *et al.* 2007). Hearing thresholds: lower values from data compiled by Thomsen *et al.* (2006).

As outlined above, noise from offshore pile driving reached highest levels in the low frequencies (100 to 1000 Hz), whereas hearing abilities of marine mammals reached the optimum in high frequencies above 10000 Hz (Fig. 2.8). However, in the range of their best hearing abilities noise from pile driving may still be 80 to 100 dB above the hearing threshold (Fig. 2-8) and thus be audible over large ranges. Most fish species have their best hearing ability in the range of 30 Hz to 3 kHz (Fay 1988, Nedwell *et al.* 2004).

Anthropogenic noise can adversely influence the distribution, habitat use and behaviour of marine animals and even cause physical harm. The impact depends on the source level, sound radiation, characteristics of noise (pulsed, continuous), hearing abilities and motivation of the animal. Investigating potential effects of noise on marine animals, often the radii are assessed within which different acoustic effects are expected. Usually, four zones of noise impact are differentiated (Richardson *et al.* 1995):

- the zone of physical impairment through hearing loss or injury
- the zone of masking
- the zone of responsiveness and
- the zone of audibility

The zones are usually illustrated as circles indicating the distance from the noise source. However, little data are available so far to relate a certain strength and characteristic of a noise source with the extension of the zones concerned. Estimating the extent of the largest zone, the **zone of audibility**, the hearing threshold of a species is compared with the strength of an acoustic signal and if the signal exceeds both the hearing threshold and the level of ambient noise, audibility is inferred. However, hearing thresholds of marine mammals are not easy to measure and there are considerable differences between the data from different studies. For e. g., values given in literature for the hearing threshold of harbour porpoises in the zone of best audibility vary by about 40 dB (e.g. Thomsen *et al.* 2006, but see Southall *et al.* 2005). Zones of audibility derived from these values would vary accordingly.

In the **zone of responsiveness** animals often avoid a sound stimulus or abandon their social or feeding behaviour, but apart from disturbance or displacement from certain area, a variety of further responses are possible (Hildebrand 2006, Thomsen *et al.* 2006). Animals may respond to any signal from anthropogenic noise which is audible to them but research on how a response can be related to certain characteristics of a signal is still in an early stage (Kastelein *et al.* 2005, Kastelein *et al.* 2006, Lucke *et al.* 2007). As a response may not only depend on the strength of a signal but also on various further variables such as signal duration, ambient

noise conditions in a given area and the disposition of the animals, there are no general rules in estimating the extension of this zone, although it can be assumed, that the extent of this zone must be related to the strength of the signals.

In the **zone of masking**, man-made noise interferes with the detection of sounds which have a biological significance for marine animals. These sounds can be masked by noise in similar frequency bands (Madsen *et al.* 2006, Thomsen *et al.* 2006). Because of the short duration of the ramming operation and because the noise emissions are in much lower frequencies than echolocation, masking might be considered to be a less significant problem in offshore pile driving signals.

The innermost **zone of physical impairment** has been described by several studies measuring directly TTS (Temporary Threshold Shift) which is the mildest – because reversible – form of physical impairment (Richardson *et al.* 1995) and this may eventually be the most robust estimates of the responses of marine mammals to anthropogenic noise. However, the degree of a physical damage will depend on several properties of sound: the received energy content, peak pressure, signal duration, spectral type, frequency (bandwidth), duty cycle, directionality, and signal rise time. Thus, an accurate outline of this zone based on a single parameter of the noise source is not possible.

Regarding the impacts of offshore pile driving on marine mammals, both the zone of physical impairment and the zone of responsiveness are considered as especially relevant. Information on both zones or effects is needed to be able to recommend a certain degree of attenuation through mitigation measures. Based on other publications from their research team cited therein, Parvin *et al.* (2006) infer sound levels and extension of these zones in relation to the hearing threshold of marine animals. The so-called dB_{ht} scale adds per frequency a given value specific to the hearing threshold. For marine mammals, Parvin *et al.* (2006) expect behavioural impacts from a value of $90 \text{ dB}_{\text{ht}}$ onwards and predict auditory injury from a value of $92 \text{ dB}_{\text{ht}} L_{\text{eq}}$ onwards. This approach, which has been applied in a variety of impact assessments on offshore windfarms, seems to be questionable and neither behavioural impacts nor auditory injury data were presented which could underpin this approach. As mentioned above, data on hearing thresholds differ considerably between studies. A general addition of a given value to the hearing threshold is also problematic, as this would not set any limits to noise in the range where hearing abilities are low, especially in the lower frequencies where noise from pile driving is highest. However, the range between audibility and discomfort or ear damage gets narrower in the higher and lower frequencies where the hearing abilities decrease. So-called curves of equal loudness follow closely the hearing threshold at low sound pressures but become flat as sound pressure increases. A frequency weighting thus seems not to be applicable at high sound pressures (s.a. SMRU 2007). Richardson *et al.* (1995) already discussed a similar “80 dB above threshold” criterion in relation to the onset of PTS but state that the available data do not allow for solving the uncertainties involved with it. As no studies have been published thereafter which could form a base for estimating zones of injury or disturbance, frequency weighting is at present not considered to be feasible. In defining critical sound levels of SURTASS LFA sonar signals, reference has been made to the hearing thresholds of marine mammals, however, only to identify the most sensitive frequency and no frequency weighting has been done after this (SURTASS 2007). Although frequency weighting is considered to be useful in estimating the range of audibility and thus be relevant also to estimate responses of marine animals, the usefulness of this concept in relation to physical impairment appears to be questionable.

2.3 Setting targets for noise mitigation

Noise mitigation has been considered predominantly to safeguard marine mammals, but also fish. Noise mitigation may fulfil two tasks: First, to avoid physical damage and death to marine animals; second, to avoid or reduce disturbance to marine animals and maintain the significance of an impact area for marine animals. As noise mitigation measures will affect both the time and financial budgets of any piling operation, an important question remains, at which level of noise should they be implemented and what are the targets of noise mitigation? It is outside the scope of this report to develop criteria for the implementation of noise mitigation measures and in general it is recommended to decide on the basis of the EIA of a given project

whether, and to what extent, noise mitigation or other measures are required to safeguard marine mammals and other marine wildlife. Areas with large numbers of marine mammals and sites within or close to marine reserves may be treated differently from sites of comparatively low numbers of sound-sensitive species. In the following a brief discussion on some criteria when to implement noise mitigation measures is provided.

2.3.1 Avoiding physical damage

Pulses or continuous noise may lead to reversible or permanent damage to marine mammals' hearing abilities. At very high sound pressure levels, damage may not only occur to ears but to any tissue or can cause the death of animals. Direct measurements are available from several species of marine mammals on Temporary Threshold Shift (TTS) from which a Permanent Threshold Shift (PTS) can be inferred. For data on other physical damage it is referred to Richardson *et al.* (1995). Ketten & Finneran (2004) have summarized recent findings on the onset of TTS and PTS and formulated the following recommendations at which levels TTS and PTS have to be considered:

TTS:

Cetaceans: 183 dB SEL pulses, 224 dB peak pressure

Pinnipeds: 163 dB SEL pulses, 204 dB peak pressure

PTS:

Cetaceans: 215 dB SEL, 230 dB peak pressure

Pinnipeds: 210 dB peak pressure

These data may be taken as a base for delineating impact areas. Pending the development of new criteria for acoustic effects, and following current US National Marine and Fisheries Sciences regulations, Madsen *et al.* (2006) likewise define the zone of injury for the cetaceans as any area where the sound level is 180 dB re 1 μ Pa (RMS) or higher, which is rather similar to the values given by Ketten & Finneran (2004). However, the value from Madsen *et al.* (2006) of ≥ 190 dB re μ Pa (RMS) for pinnipeds is higher than the approach of Ketten & Finneran (2004). The reason for choosing a higher value for pinnipeds than for cetaceans is not clear. Underwater hearing abilities are better in cetaceans than in pinnipeds at high frequencies but the situation is reversed at lower frequencies (Fig. 2-8). As noise from pile driving and other anthropogenic noise sources is strongest in the lower frequencies, the sensitivity of pinnipeds may not necessarily be lower. For SURTASS LFA sonar signals, which have a ping duration of about 1 minute, 180 dB have been defined as risk criteria for marine animals in general (SURTASS 2007). In a note to the Washington State Department of Transport, Popper and co-workers (2006) criticize the 180 dB criteria as lacking a scientific basis and being too low for fish. According to their research they propose that interim criteria to prevent fish from physical damage for pile driving should be set at an SEL level of 187 dB re: 1 μ Pa²s and a peak sound pressure level of 208 dB re: 1 μ Pa in any single strike.

Recent data indicate that noise levels proposed by Madsen *et al.* (2006) may be exceeded during pile driving operations in a range of at least some hundred meters and they recommend a safety zone of about 2 km. Own calculations (Tab. 2-4) lead to a radius of 500 m where a sound level of 180 dB SEL may be reached when driving large piles and a safety zone of 1-2 km appears to be justified. If marine mammals are to be expected in this area noise mitigation measures are recommended. Alternatively, marine mammals may be deterred from the area by either a soft start procedure or by using Acoustic deterrents (e.g. SMRU 2007).

2.3.2 Mitigating disturbance

Responses of marine mammals to anthropogenic noise are complex and cannot be easily related to a single characteristic as sound level, frequency or duration. Hildebrand (2006) expects that

behavioural responses may be influenced by hearing sensitivity, behavioural state, habituation or desensitization, age, sex and presence of offspring of marine mammals as well as by the location of exposure and proximity to a shoreline. Richardson *et al.* (1995) report avoidance reactions of marine mammals exposed to continuous sounds above 120 dB and concludes that marine mammals would avoid areas with continuous levels above 140 dB. Other studies reported behavioural responses to higher noise levels but little is known so far about the onset. Behavioural responses have been observed at moderate received levels: Kastelein *et al.* (2005) experimentally tested the reaction of harbour porpoises in a floating pen to different signals with frequencies around 12 kHz. They found aversive responses at received levels (L_{eq}) of 97 – 111 dB and described these levels as discomfort thresholds. Similar experiments with captive harbour seals resulted in discomfort thresholds at (L_{eq}) 107 dB (Kastelein *et al.* 2006). They conclude, that the discomfort zone should not coincide with ecological important areas for marine mammals. Noise measurements from offshore pile driving (Tab. 2-1) indicate that these values would be exceeded in a distance of several kilometers at similar frequencies as in the experiments. However, the test tones used in the studies were mainly narrowband and at high frequencies, thus a direct comparison to noise emitted from offshore pile driving is not possible. Lucke *et al.* (2007) report behavioural reaction of a harbour porpoise to impulsive sounds (< 500 Hz) at received pressure levels above 160 dB. The difference to the experiments of Kastelein *et al.* (2005) is likely to reflect the frequency-dependent hearing abilities of marine mammals (Fig. 2-8).

To date, the only available study on effects of offshore pile driving on the behaviour of marine mammals is a study conducted during the construction of the Danish offshore windfarm Horns Rev. Based on POD data, Tougaard *et al.* (2003) report changes in behaviour and attendance of harbour porpoises lasting until about 4.5 hours after the termination of a ramming operation and behavioural effects were recorded up to a distance of 15 km. At this distance, sound pressure (peak to peak) was somewhat higher than 160 dB (Tougaard *et al.* 2007). Very limited data about the response of harbour seals at sea are available. As seals do not rely on acoustic orientation they possibly might be more tolerant to disturbance by underwater noise even though their hearing abilities are good in the low frequencies where noise is strongest.

The available data indicate, that noise from offshore pile driving will be audible against ambient noise over large distances of several 10 kilometres and a first study indicated that behavioural responses may occur in a range of 10 to 20 km at least. This corresponds to an area of 314 to 1260 km² and might thus affect a high number of marine mammals. Unlike in estimating physical damage, it appears to be very important to consider the frequency of noise emissions when estimating the area where disturbance may be relevant. To date, no recommendations for threshold levels to prevent or mitigate disturbance have been recommended, which could be applied to noise emissions from offshore pile driving have been published. Referring to the data presented by Tougaard *et al.* (2007), a reduction of underwater noise below 160 dB (peak) at low frequencies (< 1000 Hz) can be expected to reduce behavioural responses and disturbance. A corresponding SEL level would be approximately 135 dB which is close to the level of 140 dB proposed by Richardson *et al.* (1995) for continuous sounds. At higher frequencies noise levels should be considerably lower. As a first proxy, we will refer to a noise level of 140 dB SEL as disturbance radii to illustrate the effects of noise mitigation measures. However, more work needs to be done in order to develop scientifically sound recommendations.

3. Methods to reduce underwater noise

3.1 Characterisation of the acoustic efficiency

In waters with depths greater than about 10 m, the sound level of pile driving noise decreases by 4-6 dB when the distance from the sound source is doubled. At high sound frequencies and large distances, the decrease is stronger due to the sound absorption in water. In very shallow water it is also higher because of the lower limiting frequency of the propagation channel (see figure 2-4). However, in general, a decrease by 5 dB per distance doubling is a useful rule of thumb. That means, if the noise of construction works can be lowered by 5 dB, the radii of the zones where injury, TTS and disturbance of marine mammals have to be expected, are reduced

to one half and the corresponding areas to one fourth. A reduction of 10 dB would reduce all radii to 1/4, and so on.

The efficacy of noise mitigation measures is often specified by a single number, i.e. the broadband attenuation in dB. This number is only valid for a specific type of sound, e.g. pile driver noise, since both source level and attenuation are a function of frequency. The single-number attenuation value mainly reflects the minimum attenuation that is reached at a certain frequency.

Single-number descriptors are handy but not always sufficient. Figure 3-1 shows two hypothetical noise mitigation measures. Method A reduces any sound by 5 dB, regardless of the frequency. Method B provides a high reduction by 40 dB above 1000 Hz and no attenuation below. Method A has a single-number value of 5 dB, while method B, when applied to pile driver noise, yields little more than 0 dB and thus appears worse than A. Method A is the better one to avoid injury in the vicinity of the pile driver, but in order to avoid disturbance at larger distances to species with good high-frequency hearing capability, B might be better. Hence besides the broadband value, frequency-dependant values are useful to evaluate the effect of a noise reduction technique.

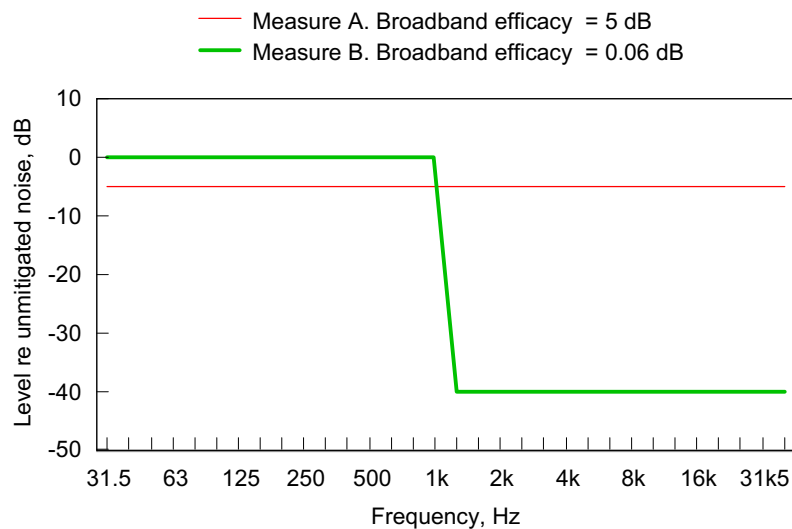

Fig. 3-1. Two hypothetical noise mitigation measures with different sound reduction versus frequency. When applied to pile driver noise, method B yields a poor single-number value though it might be the better one for avoiding disturbance to marine mammals at larger distances from the construction site.

3.2 Modification of the piling hammer

3.2.1 Theory and construction principle

The physical principle of this approach is to prolong the impact time of the pile hammer, which results in a lower noise level.

A simple model of hammering is shown in Figure 3-2. The hammer with mass m hits the pile at velocity v . After the impact, hammer and pile move downwards together, making the pile penetrate a distance s within the impact time T . The velocity decreases and reaches zero after this time. This causes a (negative) acceleration (a) and thus, because $F = m \cdot a$, a force (F) on the pile during time (T). The shorter T , the higher the force. For further simplification, a constant acceleration is assumed after the impact; this results in a constant force during impact time T . Typical values for T are 2 to 5 ms.

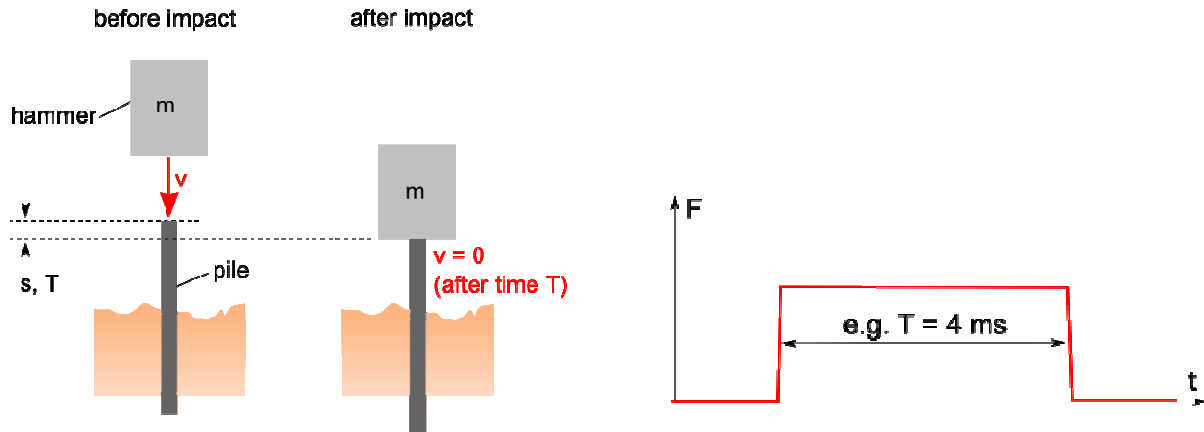

Fig. 3-2. Simplified model of hammering. The hammer hits the pile with velocity v . After the impact, hammer and pile move downwards together a distance s within time T . The velocity is reduced to zero within this time. This means a (negative) acceleration and, because force = mass times acceleration, a force F acting on the pile for a time period T .

Basically, the sound radiated by the pile is the linear filtered excitation signal; the excitation is the rectangular force vs. time function. From measured frequency spectra of pile driving blows (e.g. Figure 2-2 and 2-3), the idealised filter (or radiation) function in Figure 3-3 was derived. It has an 18 dB/octave slope below 100 Hz and 6 dB/octave above 300 Hz.

Figure 3-3 also shows spectra for rectangular impulses of different length T . The longer the impulse, the more the spectrum is squeezed towards lower frequencies. Since these low frequency components are radiated less strong, the sound level is lower if the impact time is longer.

The time function of a real hammer stroke is not exactly rectangular, but rather bell-shaped to rectangular. This results in a spectrum with less distinct zeros at frequencies $1/T$, $2/T$ etc. than in Figure 3-3. However these differences are negligible for this estimate of the overall level reduction.

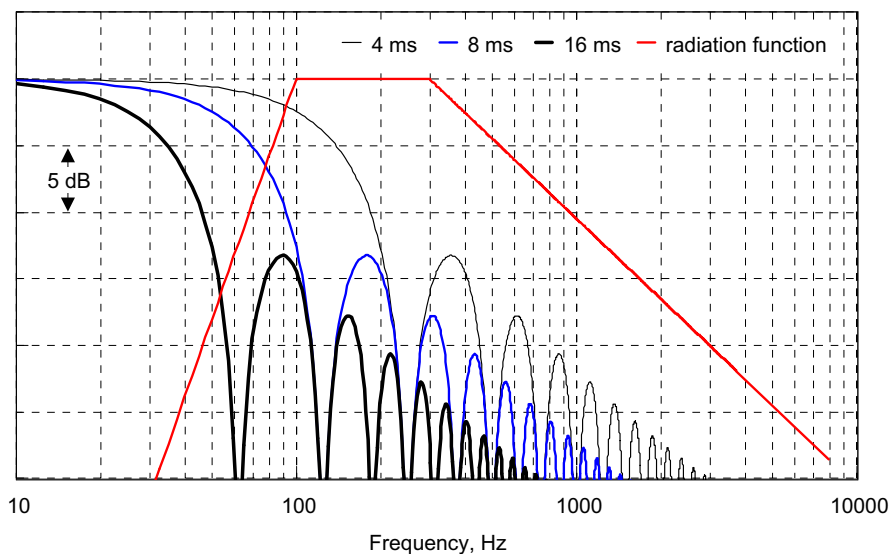

Fig. 3-3. Spectra of rectangular impulses of different lengths and assumed radiation function of the pile

The computed level reduction for an increase of impact time from 4 ms to 8 ms is approximately 8 dB. For 16 ms, the level decreases by 13 dB. It is apparent, however, that

penetration depth s , impact time T , and force F are not independent of each other. If an increase of T is accomplished by some technical means, the force decreases. This lower exciting signal effects an additional sound reduction of 3-6 dB. By numerical simulation of the stroke, Elmer (2007) predicts a total noise reduction of 10-13 dB for a doubling of impact time.

Often the loss of force can be tolerated, since in terms of penetration depth, it is compensated for to a certain extent by the longer duration. But in many other cases, the pile driver's maximum power is needed to overcome the pile friction in the sediment. In these cases, an increase of T without loss of force would also require a larger pile driver, i.e. a larger hammer mass.

In principle, an increase of impact time can be achieved by a spring or a specially shaped pile cap acting as a spring, or by a layer of relatively soft material between hammer and pile. A similar effect is obtained with a drop hammer, where contrary to the double-acting pile drivers used in offshore construction, the hammer is accelerated by gravity only with no additional acceleration by a hydraulic mechanism. The same noise reduction effect emerges if an over-dimensioned double-acting pile driver is operated considerably below its maximum power.

3.2.2 Experimental results

Soft layer between hammer and pile. During construction of the FINO2 research platform, a steel cable was put between hammer and pile. A first evaluation shows that with this soft layer, the force impulse is prolonged by a factor of two. The height still reaches about 80% of the "hard" stroke (Figure 3-4), which is higher than theory predicts (Elmer 2007). The average bow energy was approximately 300 kJ. It is not clear whether it was lower for the first two or three blows of the trial, since the pile driver operator started with a "careful", low setting. However, these first few blows are not well documented; the pile driver's log file only states average values over a number of blows.

Peak levels before, during and after the experiment are presented in Figure 3-5. At the beginning of the trial, the level is 5-7 dB lower than without the steel cable. After a couple of blows, it rises to the same or higher value. SEL spectra in Figure 3-6 show a similar effect. It is possibly because the cable is forged flat, and after a number of blows, it acts as a "washer" and improves the mechanical coupling between hammer and pile. The experiment is still under evaluation.

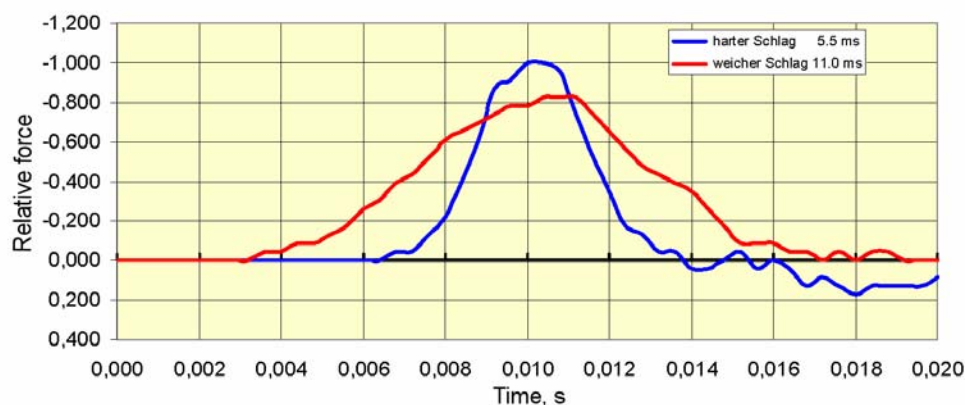

Fig. 3-4. Relative stroke force, measured with sensors (strain gauges) on the pile. Blue curve: "hard" stroke, red curve: "soft stroke" (blow no. 3; see Figure 3-5) with steel cable ring between hammer and pile (Elmer 2007)

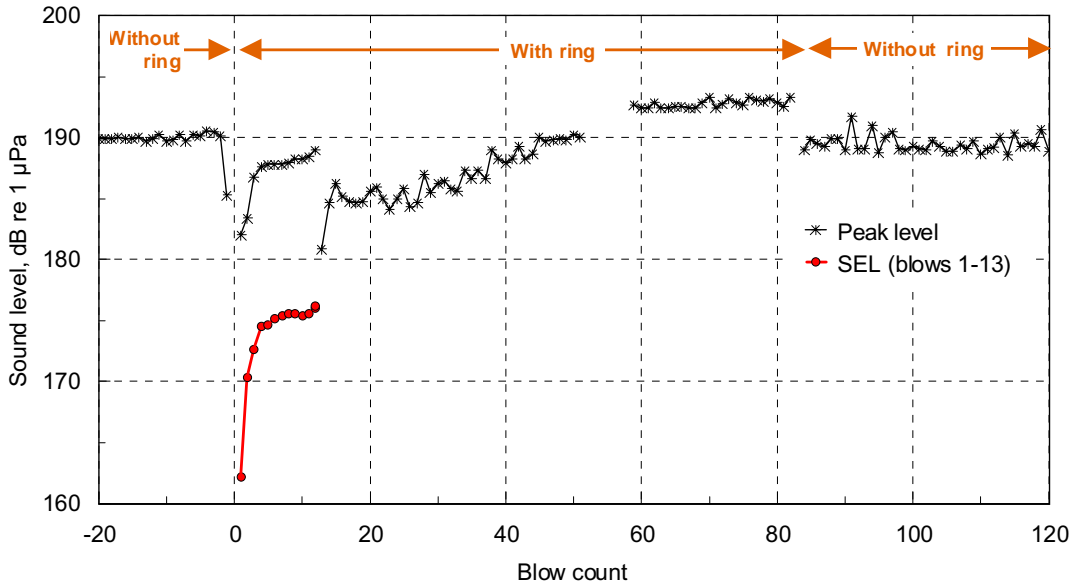

Fig. 3-5. Steel cable ring as a "cushion" between hammer and pile (Elmer 2007; measurement by ITAP). The diagram shows peak levels recorded before, during and after the experiment, as well as SELs for the first 13 strokes. The measurement was made at 530 m distance from the pile. Blows 52 to 58 were not recorded, because they fell into the autonomous measurement system's reboot procedure, which occurred at fixed time intervals.

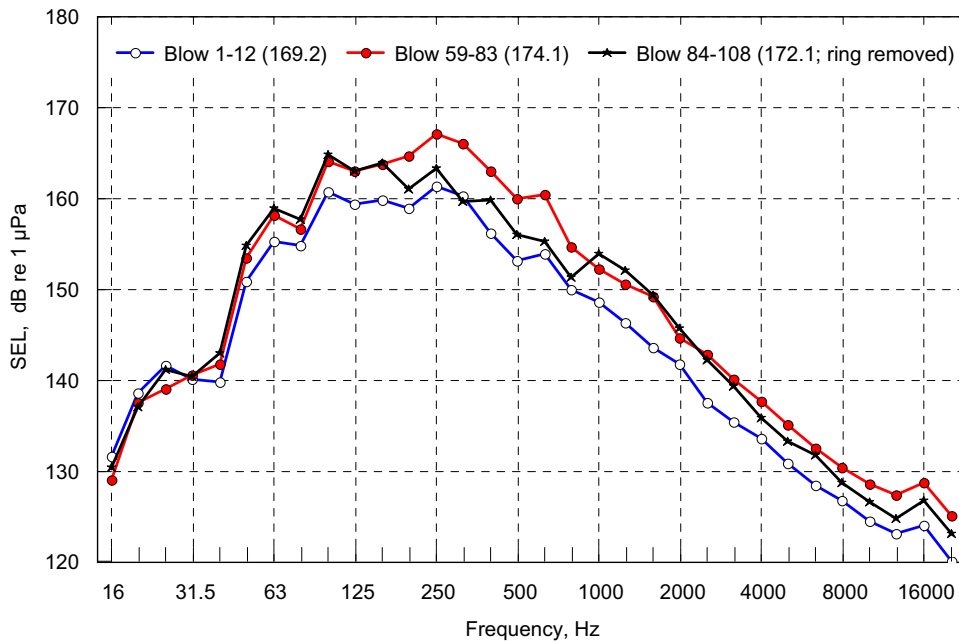

Fig. 3-6. Third octave spectra recorded during different phases of the steel cable experiment. Values in brackets are SEL totals.

Drop hammer. Figure 3-7 shows the underwater sound spectrum of a 200 kJ drop hammer on a 2.2 m pile (Schultz-von Glahn *et al.* 2006) compared to two double-acting hammers. Measured levels were normalized by adding $13 \log(200/E) + 10 \log(10/H) + 15 \log(R/500)$, where E is the blow energy in kJ, H the water depth in m and R the measurement distance from the pile in m. The single-acting pile driver produces significantly less noise in the frequency range of the spectral maximum, resulting in a 10 dB lower sum level.

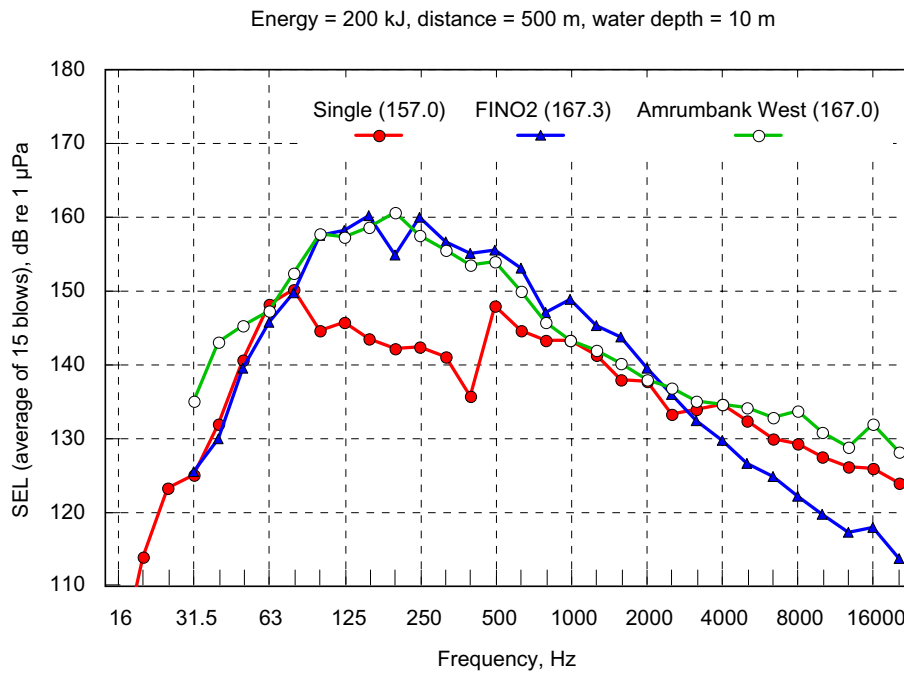

Fig. 3-7. Spectra of pile strokes produced with a single-acting pile driver (drop hammer) and with two double-acting pile drivers. Levels are normalised to equal blow energy, distance and water depth. Values in brackets are SEL totals.

3.2.3 Possible technical realisation

A modification of the pile hammer is – at first glance -a promising noise mitigation method, since it would not require time-consuming installation procedures on site. However, although a noise reduction of 10 dB or more by enhancing the stroke duration is possible in theory, the construction of a specially shaped hammer or pile cap in order to prolong the impact by a factor of 2 or more is considered problematic by MENCK's engineers.

Nylon cushions and other materials have been used on land to reduce airborne noise (Shepherd *et al.* 2006), but these components absorb energy which is difficult to dissipate in a pile driver in closed construction, as they are common in offshore works. This also applies to the steel rope used in the experiment described in section 3.2.2. At present, a both efficient and durable cushion seems to be infeasible. The approach is not abandoned, but further research is necessary.

The major shortcoming of these methods is that the prolongation of the impact time is associated with a loss of force on the pile. The industry expressed some concern that this may be in conflict with the success of pile driving. The difficulty could be overcome with a larger pile driver that provides some reserves, but this is hardly practicable. A 1900 kJ pile driver now used to install large monopiles has a weight of nearly 300 tons and a further increase could exceed the limits of cranes and carriers that are in use today.

A drop hammer is also not a feasible solution for large offshore installations. While the experiment in section 3.2.2 showed some noise reduction, the largest drop hammer currently available has a blow energy of less than 400 kJ, which is only one fifth of modern double-acting hydraulic hammers which are needed to drive large piles. In principle it is possible to construct a larger drop hammer pile driver, but the ratio of energy to weight is even worse than for double-acting hammers.

3.3 Bubble curtain

3.3.1 Theory and construction principle

Theory. The construction of a bubble curtain is simple: A tube ring with small holes is fixed to the sea bottom and air is pressed into the ring, so that bubbles ascend to the sea surface and form a “curtain”. The sound attenuation of a bubble curtain is based on the physical process of sound scattering and on the resonance of oscillating bubbles. For a particular frequency, an air bubble in water appears to a sound wave like an obstacle that is much larger than the actual bubble. The *backscattering length* can exceed that of a rigid sphere with the same diameter as the bubble by a factor of 100 (Figure 3-8).

The resonance frequency is a function of bubble diameter; the first resonance frequency f is defined by $ka = 0.0136$, where k is the wave number $2\pi f/c$ (c is the speed of sound) and a the bubble radius. The resonance frequency as a function of bubble size is shown in Figure 3-9. Though the sound attenuation of a bubble curtain is difficult to predict, it follows from the above that the efficacy can be optimised by matching the bubble size to the sound spectrum.

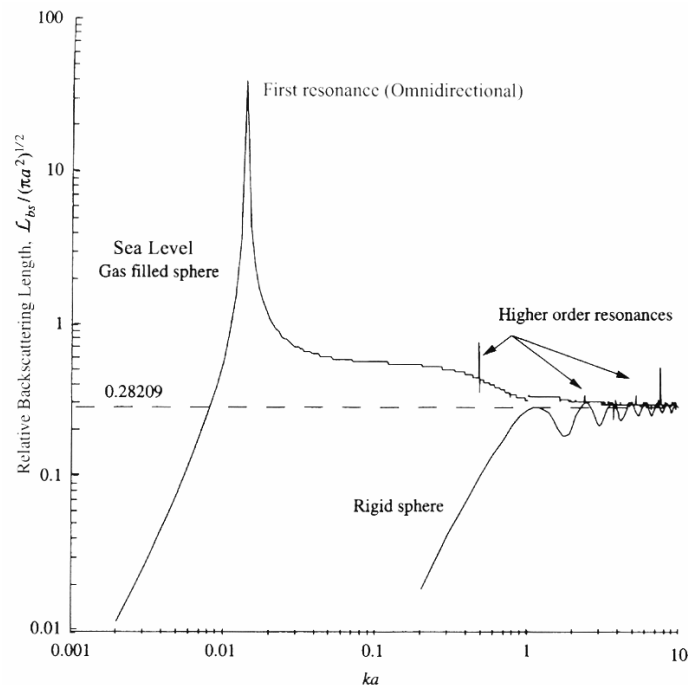

Fig. 3-8. Backscattering length of a gas bubble in water compared to that of a rigid sphere (Medwin 2005, fig. 6.12)

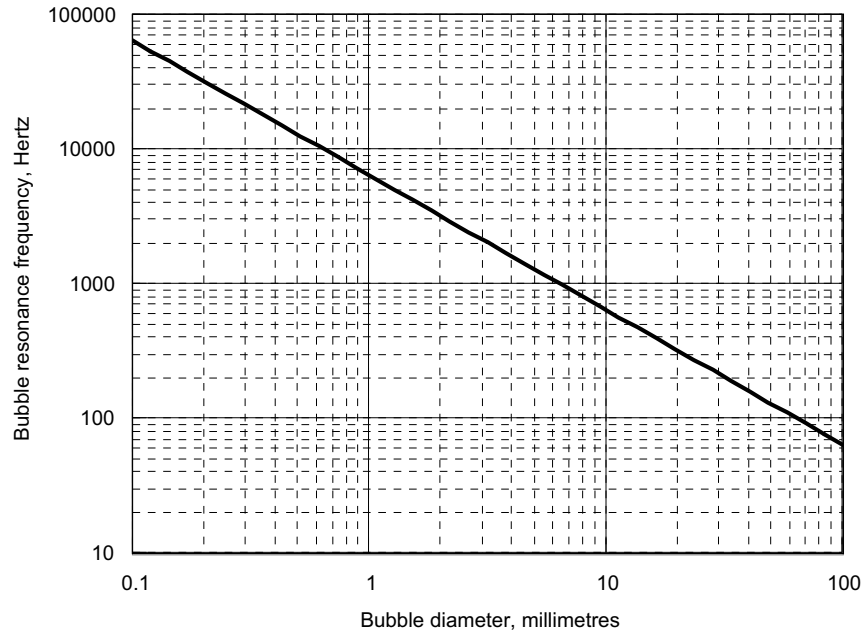

Fig. 3-9. Resonance frequency of an air bubble in water at sea level as a function of diameter

The spatial attenuation due to bubbles of one size is (Medwin 2005, p.196)

$$= 4.34 N \tag{3.1}$$

where is the attenuation in dB per m thickness of the bubble curtain, N is the number of bubbles per m³ and is the *extinction cross-section*,

$$\sigma = \frac{4\pi a^2 (\delta / \delta_r)}{[(f_R / f)^2 - 1]^2 + \delta^2} \tag{3.2}$$

where a is the bubble radius, f_R is the resonance frequency shown in Figure 3-9 and is the *total damping constant*, which is the sum of $\delta_r = k a$ plus terms for thermal and viscous damping. The ratio $\delta / \delta_r = 1$ is difficult to estimate, but computing the attenuation after equation 3.1 with $\delta / \delta_r = 1$ already provides some basic insights. Figure 3-10 suggests that the bubble curtain should contain a certain percentage of relatively large bubbles in order to achieve good noise reduction at frequencies below 1 kHz, where the maximum sound emission of pile driving occurs.

The calculation also indicates that fewer but larger bubbles are possibly more efficient than very many bubbles in the mm range. At 1 kHz, for example, one 10 mm bubble provides the same absorption as about 7000 bubbles of 2 mm diameter and requires 10 times less air volume. However, a precise theory would have to take into account that bubbles of 1 mm and larger are not exact spheroids but have an ellipsoidal shape and, amongst other issues, that the bubble volume is inversely proportional to the water depth.

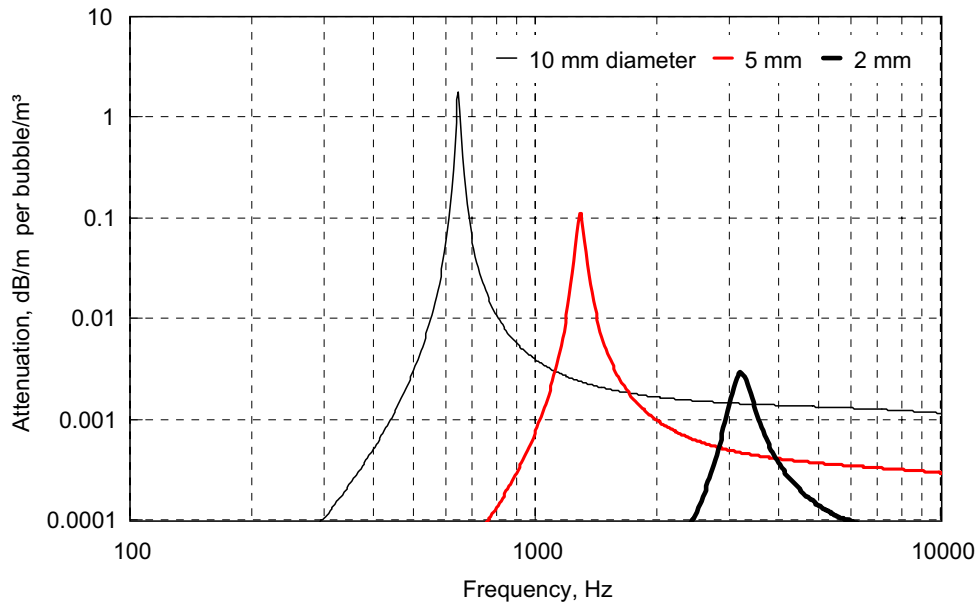

Fig. 3-10. Sound attenuation after equation 3.1 for various bubble sizes

Design aspects. No gaps or holes must be in the bubble curtain. This is not a specific demand for bubble curtains, but applies to all kinds of noise screens. In a model representation, the surface area A of a sound screen can be divided into two parts, one with perfect sound attenuation, i.e. this part of the surface radiates no sound at all, and the other part A_{loss} with no attenuation, as if it was not covered by the sound screen. The total attenuation in dB is then given by $10 \log (A_{\text{loss}}/A)$. A sound screen with perfect attenuation, i.e. an infinite dB value, but with a hole of 10% of the whole surface, would thus have an attenuation of only 10 dB. A bubble curtain (or some other noise barrier) with a 5% hole could reach an attenuation of 13 dB at most.

Furthermore, if a noise source is completely enclosed, as it should be the case here, the efficacy of a sound barrier is principally reduced, because the sound level inside the enclosure is higher than without the enclosure. This point is addressed again in section 3.4.1.

The sound attenuation in dB of a bubble curtain is proportional to its thickness. One can assume some geometric spreading of the bubbles on their way to the water surface and hence a certain thickness. If the bubbles emanate from a tube on the sea floor with a single row of holes, there will be a thin section near the bottom. This leakage is likely to cause a significant loss of efficacy of the whole bubble curtain, similar as holes in the curtain do.

Single air bubbles of 2 mm diameter and larger rise to the water surface with a final velocity of not more than 0.3 m/s (Leifer *et al.* 2000), see Figure 3-11. Bubbles with radii above 7.5 mm move slightly faster, up to 0.4 m/s, but are not always stable and tend to subdivide into smaller bubbles.

Although an intense bubble production will cause an upwelling water flow, this does not much increase the rise velocity. An inquiry to Hydrotechnik Lübeck GmbH, a manufacturer of pneumatic oil barriers, which are installed by utilising the bubble-induced current, revealed that even with a strong air conditioning compressor and a high release of air, a rise velocity of 0.3 m/s is a realistic estimate.

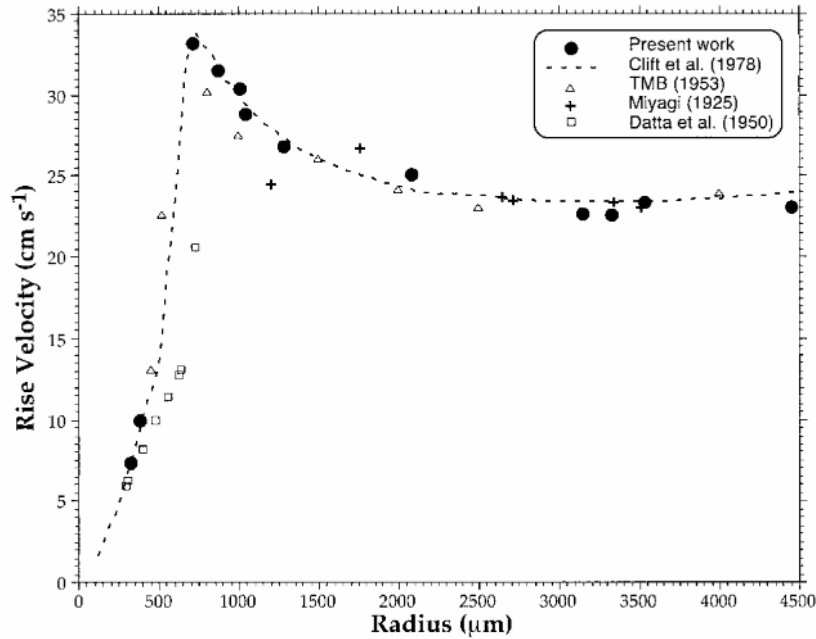

Fig. 3-11. Rise velocity of air bubbles in water at 20°C as a function of bubble size (Leifer *et. al* 2000)

Tidal currents of 1 m/s are not uncommon even in open waters of the North Sea. Under such conditions, bubbles emanating at 20 m depth would drift off about 70 m before they reach the surface (Figure 3-12). To make sure that the pile is closely enshrouded by bubbles at any time, the bubble curtain would have to be extended by this value against the tidal current and total circumference of the bubble curtain would exceed 200 m. As a consequence, much higher capacities of air conditioning compressors, energy supply and related equipment would be needed and growing difficulties would be faced to keep the bubble curtain closed. This seems not to be practicable, so precautions to keep the bubbles in place are required. One approach is a bubble curtain confined with a sleeve of fabric or other appropriate material (Figure 3-12). A second method is a vertically stacked array of bubble rings; worked out examples are shown in Figures 3-15 and 3-17. Both methods have been brought into practice at different projects.

A confined bubble curtain is probably the more efficient solution, since a bubbler manifold also requires multiple compressor capacity. In a current of 1 m/s, the bubblers would have to be stacked quite dense with more than one ring per metre depth, which might render this approach impracticable. A main problem with the confined curtain is that the sleeve presents a large flow resistance to the water current and measures will be necessary to prevent it from being pressed against the pile. A system as shown in Fig. 3-14 using a simple water permeable fabric is thus considered not to be applicable at significant currents without major modifications.

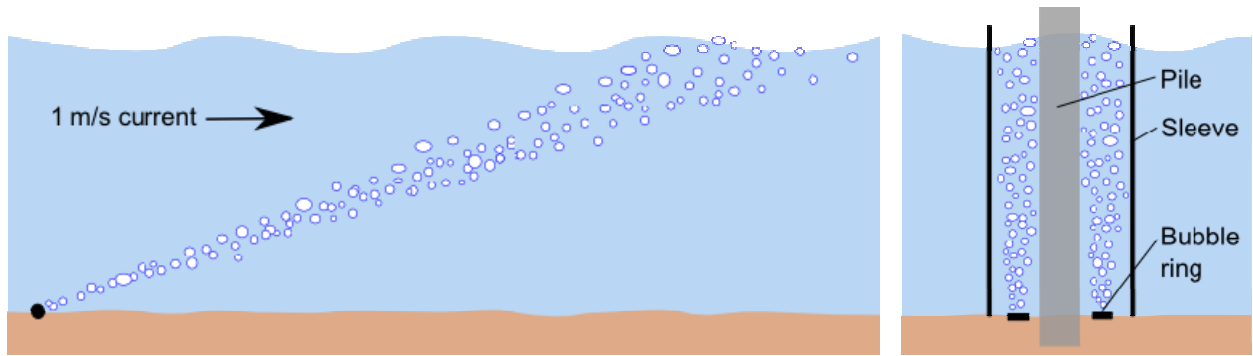

Fig. 3-12. Left: Bubble movement due to current; drift angle approximately to scale for 1 m/s. Right: Confined bubble curtain

3.3.2 Experimental results

Würsig et al. (2000). A hose with 3 mm holes every 0.3-0.4 m was anchored to the sea bottom around the pile-driving operation at a relatively large radius of 25 m (Figure 3-13). Air was supplied by two compressors with a capacity of 20 m³/minute each. With the bubble curtain on, the broadband level was reduced up to 5 dB. The greatest sound reduction was achieved at frequencies between 1 and 6 kHz (Figure 3-18).

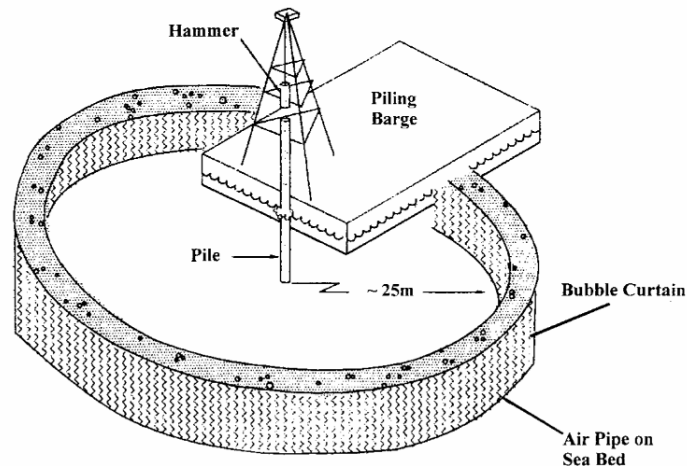

Fig. 3-13. Bubble curtain setup by Würsig et al. (2000)

Illingsworth et al. (2001). Three piles of 2.4 m diameter were installed with a large hydraulic hammer. Pile 1 was installed without noise mitigation, pile 2 with a bubble curtain and pile 3 with a bubble curtain enclosed with a fabric mantle (Figure 3-14). Air was supplied by a compressor at a rate of 45 m³/minute. Broadband noise reduction was at most 2 dB with the unconfined bubble curtain and 5-10 dB for the confined bubble curtain. Attenuation versus frequency is shown in Figure 3-18.



Fig. 3-14. Bubble curtain ring (right) and confined bubble curtain (Reyff 2003)

Reyff (2003). The three piles from the above project were "restruck" two years later. A two-ring bubble curtain system was tested at this opportunity. The bubble curtain frame supported two rings of perforated pipes that encircled the pile. One ring of pipes ran along the bottom of the frame, the second ring was 5 m above the bottom ring (Figure 3-15). To meet the objective of a bubble flux of at least 3 m³/minute per metre of pipeline in each ring, six compressors with a rating of 45 m³/minute each were required. Depending on distance and direction, a noise reduction of 3-10 dB (L_{eq} , SEL) and 9-17 dB (L_{peak}) was obtained. Spectra indicate a sound attenuation up to 30 dB at 5 kHz (Figure 3-18).



Fig. 3-15. Two-ring bubble curtain system. The white containers in the background are compressors (Reyff 2003).

Vagle (2003). Several bubble curtain operations are documented in this report. Experiments were made with a 3 m diameter bubble ring (Figure 3-16). It consisted of two outer rings of common 1/2" garden hose. Holes with a diameter of 2.5 mm were drilled every 4 cm along the upper part of the outer rings which were 10 cm apart. The air for the system was supplied by a 0.5 m³/minute compressor. Above 10 kHz, an attenuation of more than 18 dB was measured. An electro-acoustic sound source instead of a pile was used for this test. A smaller bubble curtain applied to a 20 cm steel pile provided a broadband sound attenuation of 3 dB (median value from about 10 strokes with and without bubble curtain).

Vagle also stated that the bubbles were not evenly spread around the circle, resulting in holes where the sound could escape and that in the presence of currents, the bubble screens lose their attenuating characteristics.



Fig. 3-16. Test setup by Vagle (2003). The outer ring has a diameter of 3 m and is supplied air by the square manifold in the centre.

Petri (2005). A bubble curtain system of three rings with 1.7 m diameter (Figure 3-17) was put around a pile of approx. 0.7 m diameter. The rings were stacked vertically at about 6 m. Each one had 1.6 mm holes spaced 19 mm. Air supply was 30 m³/minute for the whole system. Screen shots from a wave editor prove a peak level reduction of 5 dB. Spectra are not reported.



Fig. 3-17. Bubble curtain system with three stacked rings (Petrie 2005)

Summary of experimental results. The results from the projects discussed above are summarized in Table 3-1. Noise reduction values versus frequency, as far as available, are shown in Figure 3-18. The highest sound attenuation was obtained with the double-ring system, but at the expense of a very complex air supply. No bubble curtain operation known so far was made under offshore conditions or at noteworthy tide current. In addition, none of the publications addresses the theory of sound propagation in bubbly water, so there is some potential for improvements by carefully controlling bubble size and bubble distribution and spreading.

Table 3-1. Results from bubble curtain operations

Author	Construction	Diameter, m	Air supply (compressor rate), m ³ /minute	Water depth, m	Broadband noise reduction, dB
Würsig et al. 2000	Single ring	50	2 x 20	6-8	3-5
Illingsworth et al. 2001	Single ring	4	45	7-9	0-2
	Single ring, confined bubbles				5-10
Reyff 2003	Two rings, vertical spacing 5 m	6	6 x 45	7-9	3-10 (L _{eq}) 9-17 (L _{peak})
Vagle 2003	Two concentric rings spaced 0.1 m	3	0.5	7	Broadband value not reported. 18 dB at and above 10 kHz
	Single ring	<1	?	1.5	3
Petrie 2005	Three rings, vertical spacing 6 m	1.7	30	? (>12)	5

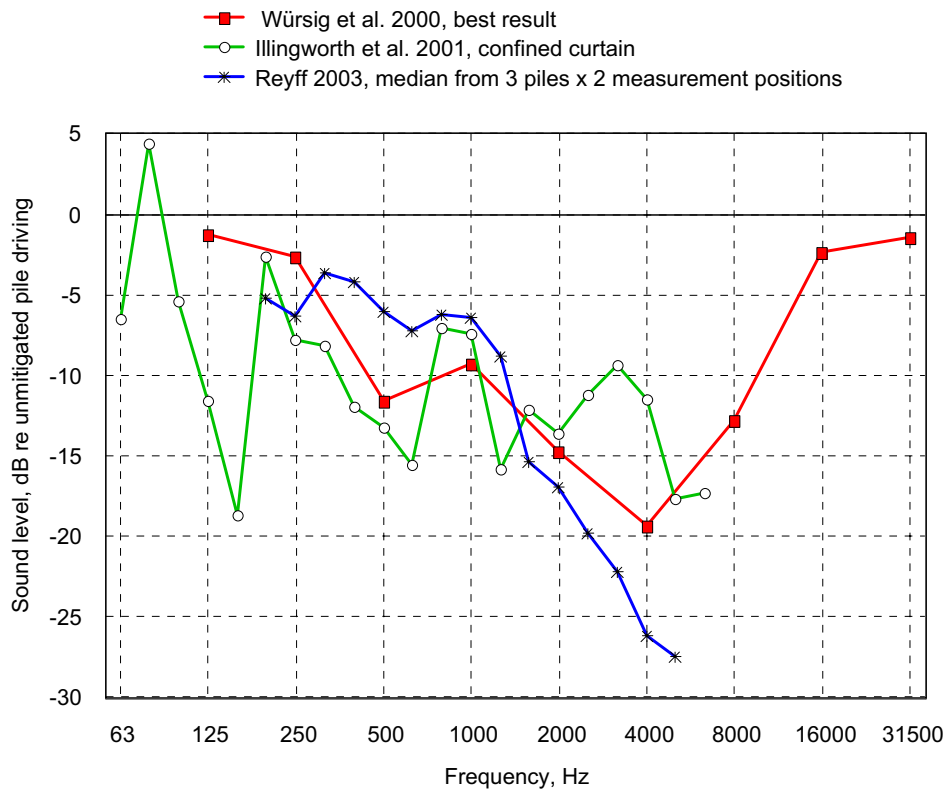

Fig. 3-18. Sound attenuation versus frequency for some of the bubble curtains in Table 3.1

3.3.3 Possible technical realisation

Bubble curtains need considerable amounts of air which are released at the seafloor. Hydrotechnic Nord estimated that an air conditioning compressor with a capacity of $30 \text{ m}^3/\text{minute}$ requiring a power supply of 200 KW would be sufficient for a closed curtain of 30 to 40 m length. However Reyff (2003) used even twice the amount. To cope for tidal currents at least 200 m would be required at a water depth of 20 m. Regarding the consequences on compressor capacity, power supply and problems with handling these large systems it is obvious that only a confined bubble curtain can provide a reliable noise mitigation. Confined bubble curtains have been used with specific designs in several occasions (e.g. www.gunderboom.de). MENCK has worked out a system which could be permanently installed on the working platform, which appears to be very important for continuous piling operation. It consists of four major components: An above water winch system, the air wall system, the upper and lower ballast guide including an air valve and an air supply system made up of air hose and compressor (Figure 3-19). The bubbles are confined within a double-wall fabric shroud. It is also possible to feed the bubbles into the space between pile and shroud; from equation 3.1 it can be concluded that if the number of bubbles remains the same, the thickness of the bubble layer does not matter. The assembly, which is to be mounted underneath the piling frame, is very similar to the inflatable pile sleeve described later. More technical details are thus given in section 3.4.3.

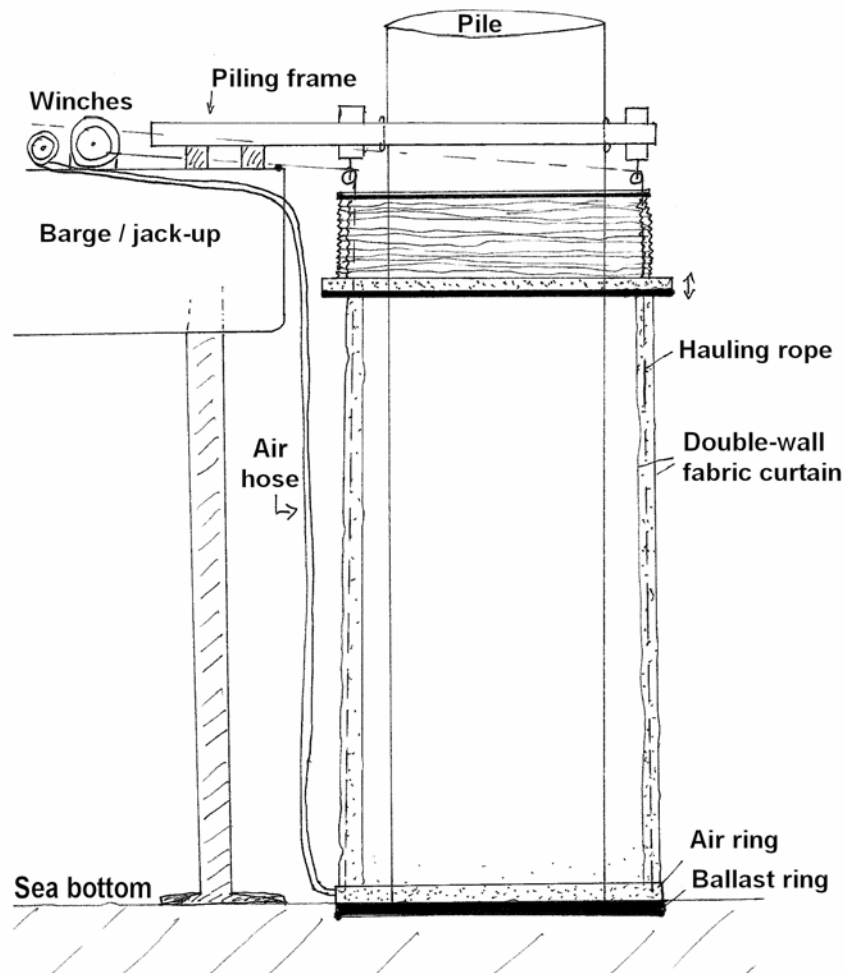

Fig. 3-19. Construction sketch of confined bubble curtain. The assembly is quite similar to the inflatable pile sleeve described later. Technical details are thus given in section 3.4.3.

3.4 Pile sleeves

3.4.1 Theory and construction principle

A pile sleeve is a sound barrier that surrounds the pile. Insofar it is similar to a bubble curtain, but physical principle and construction are different. If a sound wave encounters a material with an acoustic impedance Z that is different from the impedance of the propagation medium, the sound is partly reflected (Figure 3-20). Hence only part of the sound is transmitted into or through the material. The ratio of the amplitudes of the reflected wave and the incident wave is given by the reflection coefficient R :

$$R = \frac{Z_2 - Z_1}{Z_2 + Z_1} \quad (3.3)$$

Limiting values are $R = 1$ for $Z_2 \gg Z_1$ and $R = -1$ for $Z_2 \ll Z_1$. The modulus of the reflection coefficient thus becomes maximal if Z_1 and Z_2 differ as much as possible. The sound power transmitted into medium 2 is given by

$$T = 1 - |R|^2 \quad (3.4)$$

and the level of the transmitted sound in dB, with respect to the incident sound, is

$$L_{\text{transmitted}} = 10 \log (1 - |R|^2) \quad (3.5)$$

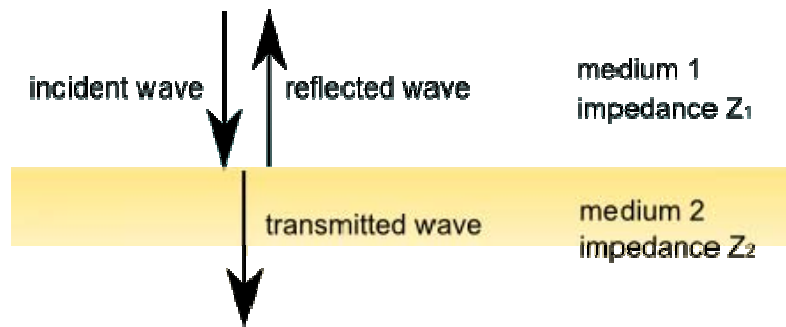

Fig. 3-20. If a sound wave encounters an impedance change from Z_1 to Z_2 , the sound is partly reflected and only part of the sound energy is passed into medium 2.

For plane waves, a common model approximation, the impedance is $Z = \rho c$, where ρ is the density of the medium (specified in kg/m^3) and c the speed of sound in it. Thus "different impedances" means first of all different densities or "weights". A concrete wall, for example, is an efficient noise barrier for sound in air. For sound in water, on the other hand, the best reflector is air or air-filled material.

In the configuration sketched in Figure 3-21, the reflection coefficient becomes (Jensen et al. 1994, p. 50)

$$R = \frac{Z_2(Z_3 - Z_1) - i(Z_2^2 - Z_1Z_3) \tan \phi_2}{Z_2(Z_3 + Z_1) - i(Z_2^2 + Z_1Z_3) \tan \phi_2} \quad (3.6)$$

with $\phi_2 = k_2 h_2 \cos \theta_2$ where k_2 is the wave number $2\pi f/c_2$ and θ_2 the incident angle of the sound wave.

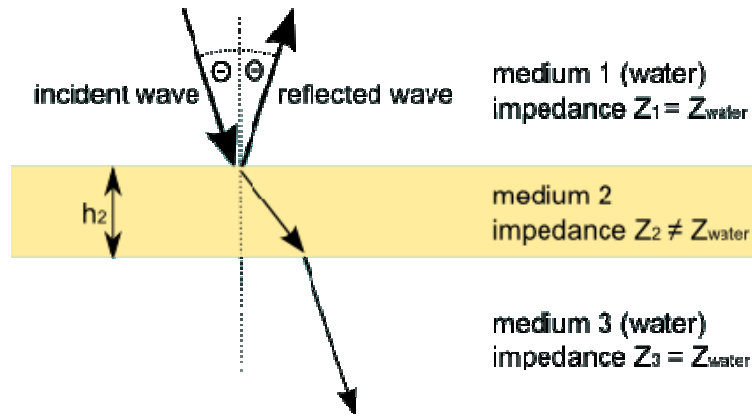

Fig. 3-21. In this configuration, the layer with impedance Z_2 acts as a sound barrier

For medium 1 = medium 3 = water and air or air-filled foam as medium 2, attenuation values obtained from equation 3.5 and 3.6 are shown in Figure 3-22. The computation for foam was made because foam was also used in the experiments described later.

At certain high frequencies, the curves show a poor sound reduction, i.e. the transmission is almost reaching 0 dB. This quarter-wavelength resonance effect is similar to optics, where the transparency of lenses can be improved by coating. Here the effect results from the simplified theory, which is accurate for low frequencies or a thin layer of medium 2 only, because the formulas do not include internal losses of the materials. In the experiments, this acoustic leakage was much less pronounced or not observed at all. It is not yet clear whether this is also the case for a "pure air" layer. More experiments and an enhanced theoretical description are necessary.

As already outlined in section 3.3.1, no holes must be in the sleeve and the pile must be enshrouded completely, otherwise the efficacy is severely reduced. A further effect is often overlooked: The simple theory described so far assumes an infinite space in front of the barrier and behind it, but this is not the case for a pile sleeve. If a sound source is completely enclosed, the sound level inside the enclosure is higher than without the enclosure, which reduces the sound insulation. The effect depends on the sound absorption inside the enclosure. Figure 3-23 shows the sound transmission for an arbitrarily chosen absorption coefficient of $\alpha = 0.1$ ($\alpha = 1$ yields the curves in Figure 3-22).

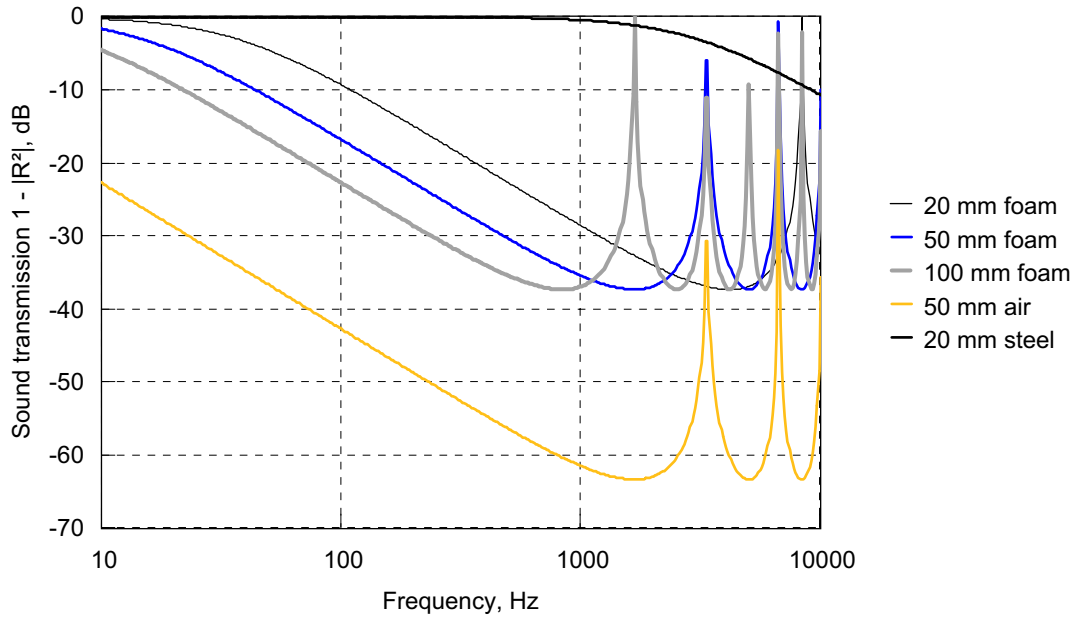

Figure 3-22. Sound level reduction obtained with layers containing air, computed after equation 3.6 and 3.5. Incidence angle = 0° , foam density = 30 kg/m^3 . Steel, for comparison, is a poor sound insulator for water-borne sound.

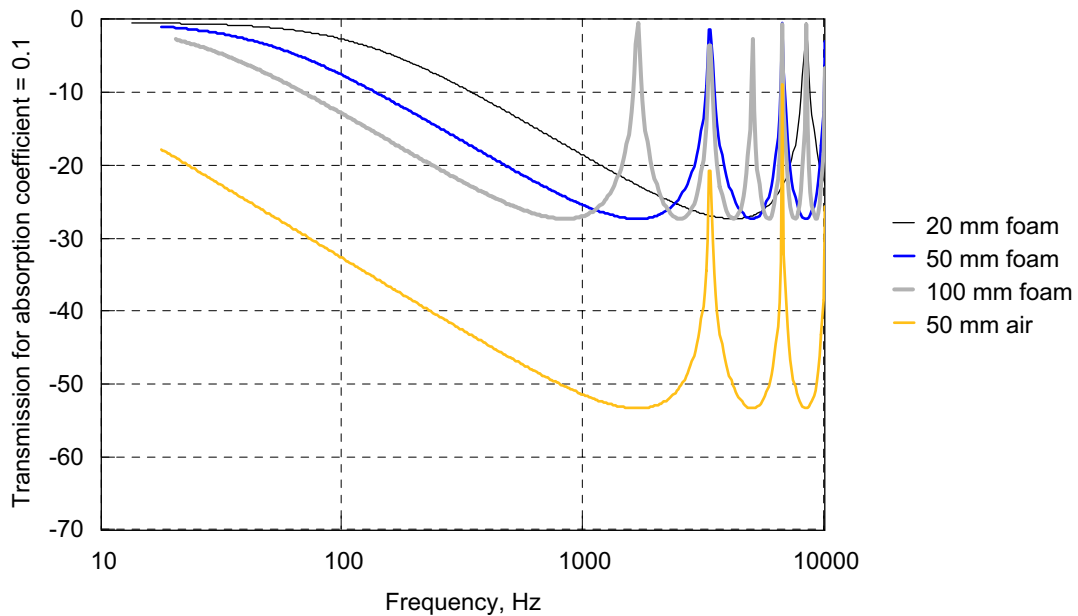

Figure 3-23. As Figure 3-22, but with imperfect sound absorption inside the pile sleeve

It has to be emphasized that the curves in Figure 3-22 and 3-23 are theoretical data only. The actual value of the absorption coefficient is difficult to estimate for water-borne sound and can lead to a noise reduction that is different from than shown in Figure 3-23. Furthermore, a "pure air layer" can only be realised as an approximation, e.g. by the inflatable system described in section 3.4.3. Inevitable supporting structures like hose walls etc. will probably lead to less sound reduction than the curves for air in Figure 3-22 and 3-23 predict. A solid assessment of a pile sleeve's efficacy is feasible by experiment only.

3.4.2 Experimental results

The setup of an experiment conducted by Schultz-von Glahn *et al.* (2006, also in Betke *et al.* 2006) is sketched in Figure 3-24. An approximately 20 mm thick layer of foam was fixed on a steel tube carrier (Figure 3-25). This tube was put over a pile of 2.2 m diameter. The pile has a wall thickness of 50 mm and has been installed in the late 1980s by MENCK in the Baltic Sea near Travemünde for testing pile driving equipment. The foam layer was made of several windings of 5 mm thick standard PE foam foil, as it is laid e.g. under wooden floors to reduce tapping noise. The hydrostatic pressure was compensated for by additional turns of foil on the lower part of the tube.

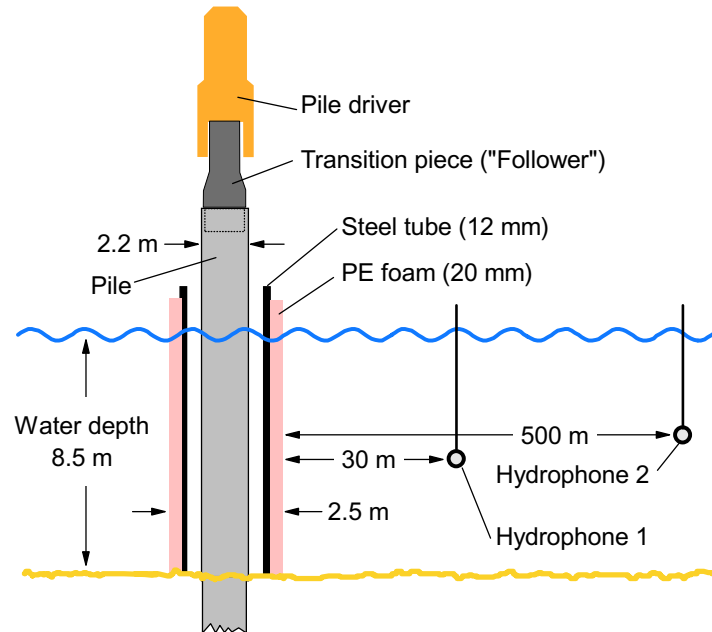

Figure 3-24. Setup for evaluating a pile sleeve (Schultz-von Glahn *et al.* 2006)

The underwater sound of the pile driving blows was measured at two distances with and without sleeve. Blow energies were 50, 100, and 200 kJ. The efficacy of the steel tube without foam coating was measured as well. A further measurement series was done with a pile sleeve of 5 mm Neoprene CR rubber. Sleeves of 3 to 6 mm thick rubber are sometimes used to reduce airborne pile driving noise and the purpose of the test was to evaluate whether they can be used with little or no modification for reducing underwater noise.

Results are shown in Figure 3-27. The rubber sleeve proved to be completely inefficient. The foam-coated tube provided a noise reduction of 10 dB at 1 kHz and 20 dB or more at and above 10 kHz. The measurement of the uncoated tube shows that the reduction is caused by the foam and not by the supporting 12 mm steel layer.

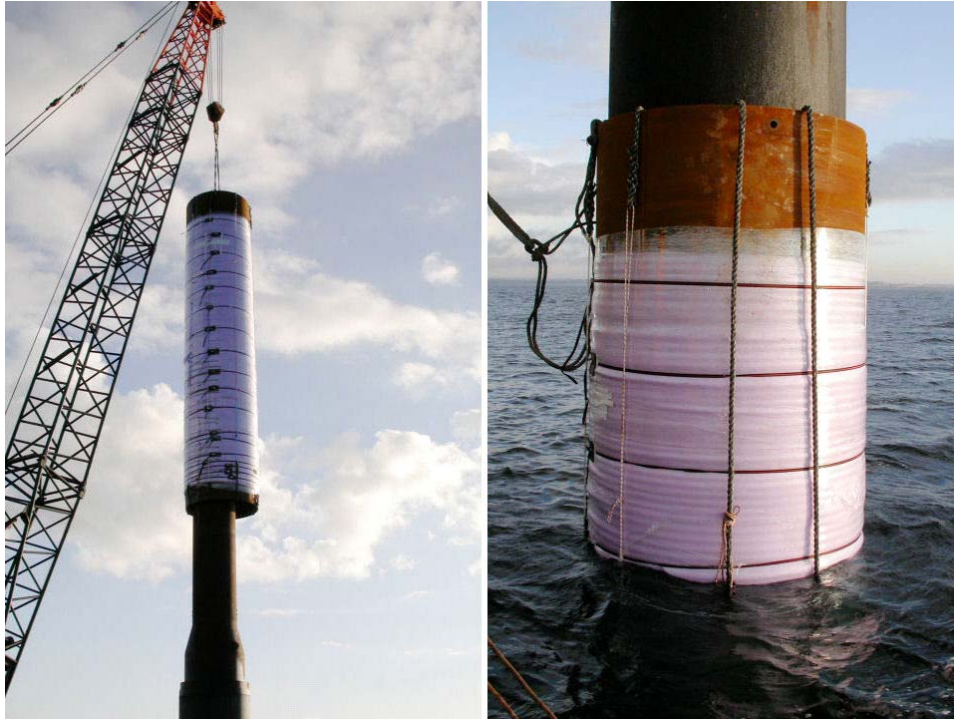

Figure 3-25. Foam-coated steel tube in measurement position (right)



Figure 3-26. Pile sleeve made of 5 mm rubber

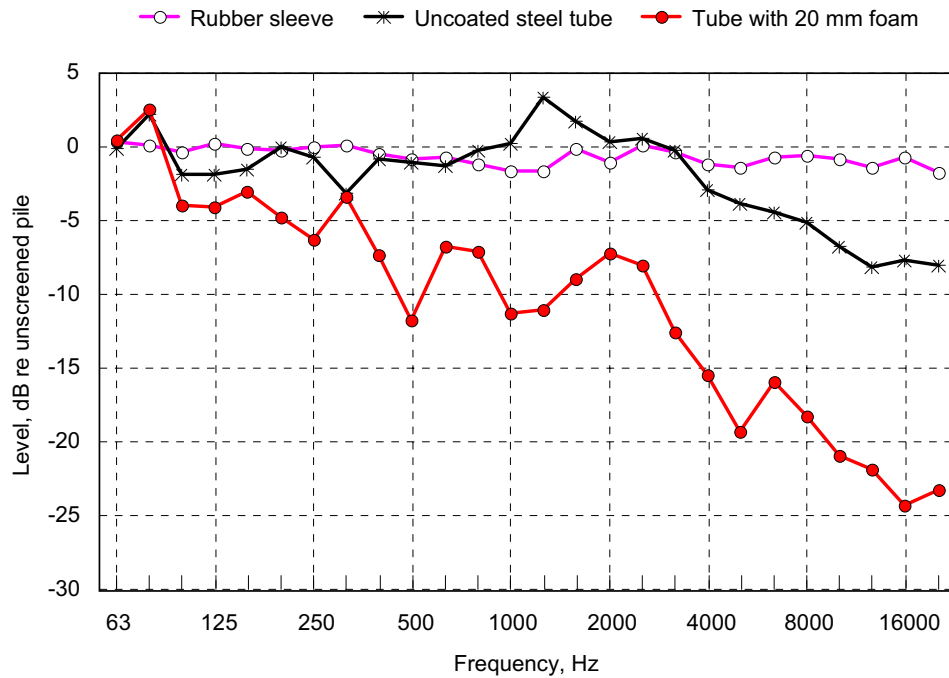

Figure 3-27. Results of the pile sleeve experiments. The foam-coating provides a noise reduction of 10 dB at 1 kHz and 20 dB or more at 10 kHz and above (Schultz-von Glahn *et al.* 2006).

It is evident that the experimental setup with foam foil is not suitable for real working conditions; the unprotected foam is not very durable and subject to be damaged during handling and transportation. Also the theory suggests that a thicker layer of air or air-containing material will improve noise reduction. For this reason, a test was made with standard fitting foam glue enclosed in a double-wall structure of glass-fibre reinforced plastic (Figure 3-28). The result is shown in Figure 3-29 (ISD *et al.* 2007). Due to the small size of the model, values are restricted to frequencies above 1 kHz because sound with wavelengths above approx. 1 m do not propagate in the shallow water of the test basin. However, above 1 kHz a sound attenuation of significantly more than 30dB was obtained.



Figure 3-28. Double-wall model of a pile sleeve with a 50 mm foam layer and test setup with two hydrophones and a piezo-electric transducer as sound source inside the tube.

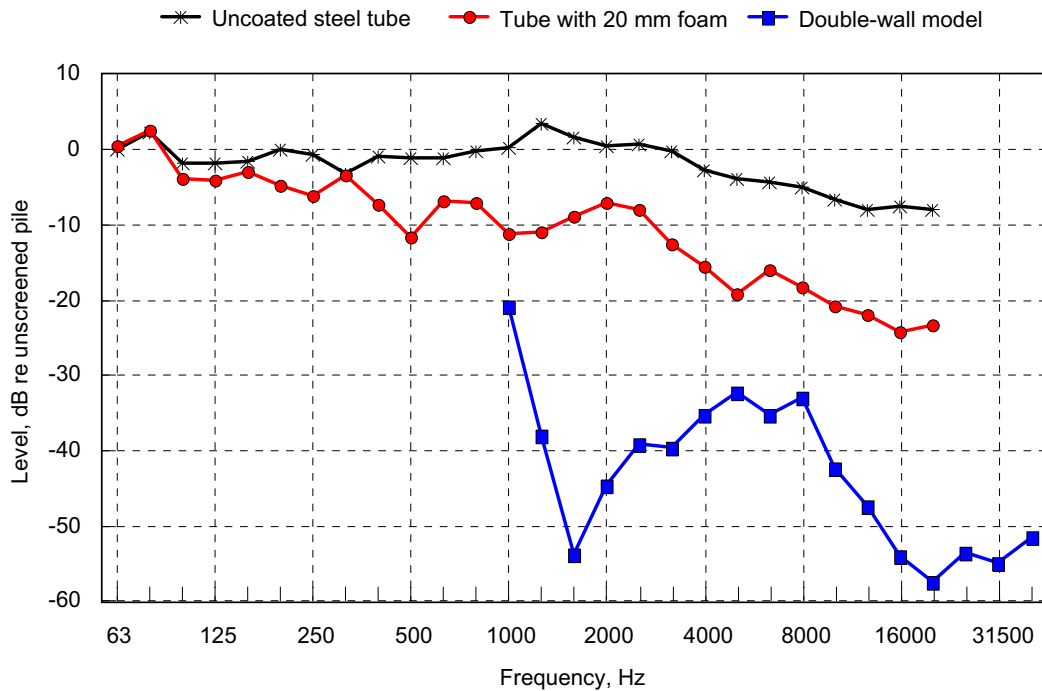

Figure 3-29. Noise reduction measured on the double-wall model. The results with the foam-coated steel tube from Figure 3-27 are shown for comparison. Due to model scale, the measurement was limited to frequencies above 1 kHz (ISD *et al.* 2007).

3.4.3 Possible technical realisation A: Inflatable pile sleeve

Design and handling procedure. The system described here is intended for a maximum pile diameter of 5 m, a maximum water depth of 25-30 m and a noise reduction of about 20 dB at 100 Hz, and 40 dB at 1 kHz and above. It consists of four major components with an above-water winch system, an air wall hose system, upper and lower ballast guides including an air valve, and an air supply system consisting of air hose and compressor.

The inflatable noise protection sleeve is designed to be mounted underneath the barge piling frame, which keeps the pile in position and adjusts the vertical position of the monopile before driving starts. As the inflatable sleeve is designed as a single, independent mitigation tool, it can be attached to nearly every existing barge piling frame, also to double guided barge piling frames as long as the lower guide stops at sea level. Should the lower guide operate under water, the inflatable sleeve should be sufficient in diameter to surround the lower guide.

With the mobilization of the piling barge or jack-up, the inflatable sleeve will be once mounted underneath the (upper) platform/guide of the piling frame connected by a winch system to the bottom ballast ring of the inflatable sleeve (Figures 3-30, 3-31, 3-32), whereby the sleeve will be in up lifted position. As the inflatable sleeve system will remain underneath the piling frame during the complete piling works no additional crane operation is needed to handle the inflatable sleeve.

As the inflatable sleeve casing requires an opening respectively lock system according to the barge piling gate system, a clamp system with hinges is incorporated in the upper guide and lower ballast ring of the sleeve to insert the pile into the barge piling frame and respectively into the inflatable sleeve (Figure 3-33).

After positioning the pile inside the frame and sleeve, the sleeve will be closed hydraulic wise in the up lifted position. Once the pile is adjusted and fixed by the piling frame, the winch system will lower the bottom ballast ring of the sleeve and the deflated, folded air hose wall will be extended. As the ballast ring is lying on the seafloor, the underwater part of the monopile will be surrounded by the deflated air hose wall system. On top of the lower ballast ring an air supply system with air valves is incorporated to inflate the vertical air chambers, which are

planned to consist of single air hoses connected vertically to each other or to consist of a double wall system with vertical separation. A horizontal separation could be possible as well, however, the vertical separation would make it easier to mount any valves on the upper guide. The air wall system will consist of an air sealed and seawater resistant material with a solid outer skin to avoid damages of the air hose system during lifting and lowering and during piling operations. The material properties are considered be similar to fire hose material properties, whereby material selection is not yet finalized and depends on supplier cooperation regarding design specific manufacturing with respect to stability and foldable ability. Care has to be taken especially of the inner part as it has to withstand the friction when tidal current press it against the driven pile.

The upper and lower guide (top frame and bottom ballast ring) will include hinges and a locking/opening system which will consist of regular steel and the opening/locking system for pile entry can be either a mechanical or a hydraulic system. The upper and lower closing system is designed with an overlapping of one of the movable branches over the other, see 3a and 3b. Once the air hose wall will be inflated, the pressured air curtain will overlap the closing gap accordingly due to pressurised vertical air lips.

The uplifting and lowering procedure of the ballast and air hose wall system will be executed by the separate winches positioned either on the piling frame directly or on the barge where the wires will be connected via guide pulleys underneath the piling frame to the ballast bottom ring passing the air wall system via wire guides.

Once the inflatable sleeve is completely extended, an on deck air compressor of min. 4-5 bar operating pressure will inflate the closed air hose wall system from the bottom until the air pressure is equal or higher than the water pressure and air releasing will be avoided by a lock valve system. As the outer material of the air wall system should be mechanical resistant, the inner side towards the pile is considered to be covered by sliding material to avoid too high friction between the pile and the air hose wall when the air hose wall is touching the pile due to water currents. Once the pile is driven to target penetration, the air valves at the bottom will be unlocked and the winch system will up lift the bottom ballast ring. During the up lift the air hose wall will be folded up and releases the air through valves.

The total weight of the inflatable sleeve hanging underneath the barge piling frame is estimated with 50-65 tons. As described, there is no crane necessary to handle the inflatable sleeve, what on one hand saves equipment resources and on the other hand reduces the handling time significantly. Should a single operation of the inflatable sleeve without the piling frame be required, the inflatable system has to be fixed underneath an intermediate support frame to avoid crane operations or a crane has to hold the inflatable sleeve (without a winch system) and lowering / lifting of the system has to be executed by an additional crane hook.

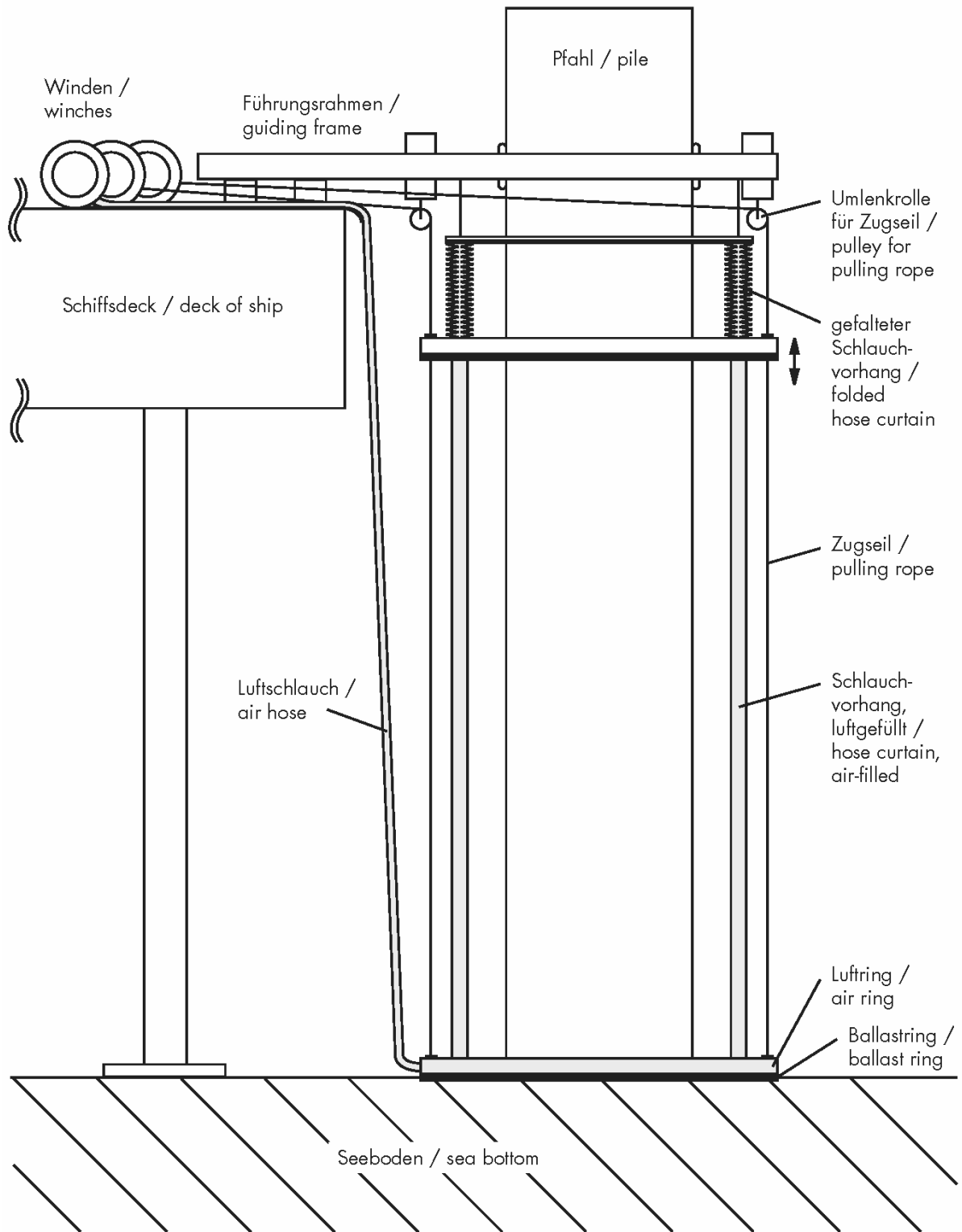

Figure 3-30. Inflatable noise mitigation system; side view

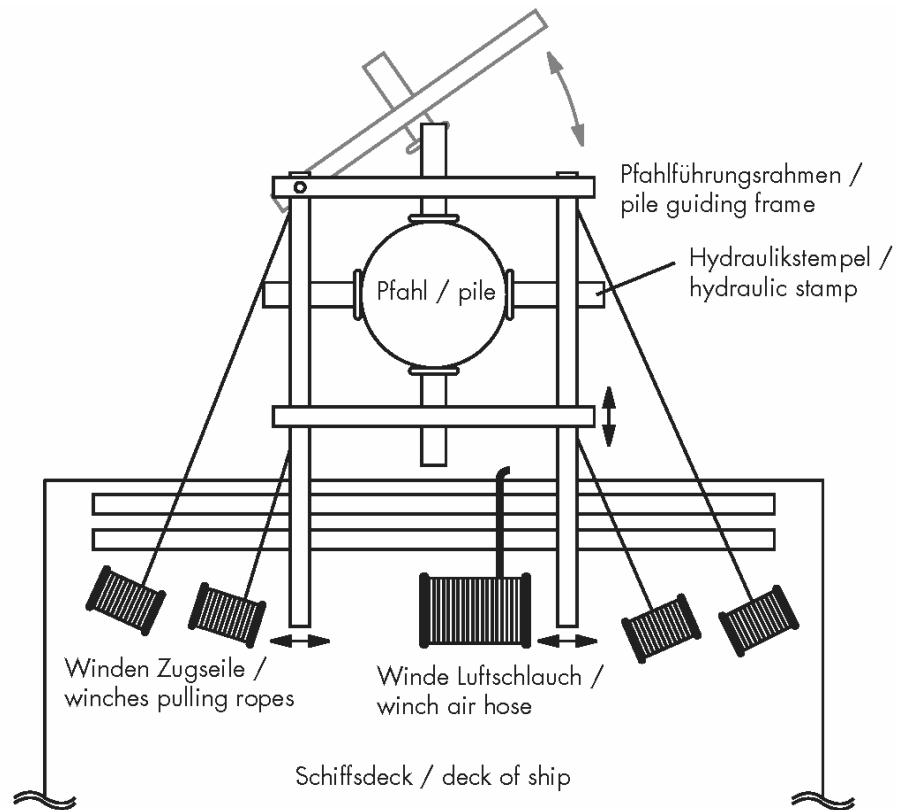

Figure 3-31. Top view: pile guiding frame with winches. Angular guiding frame

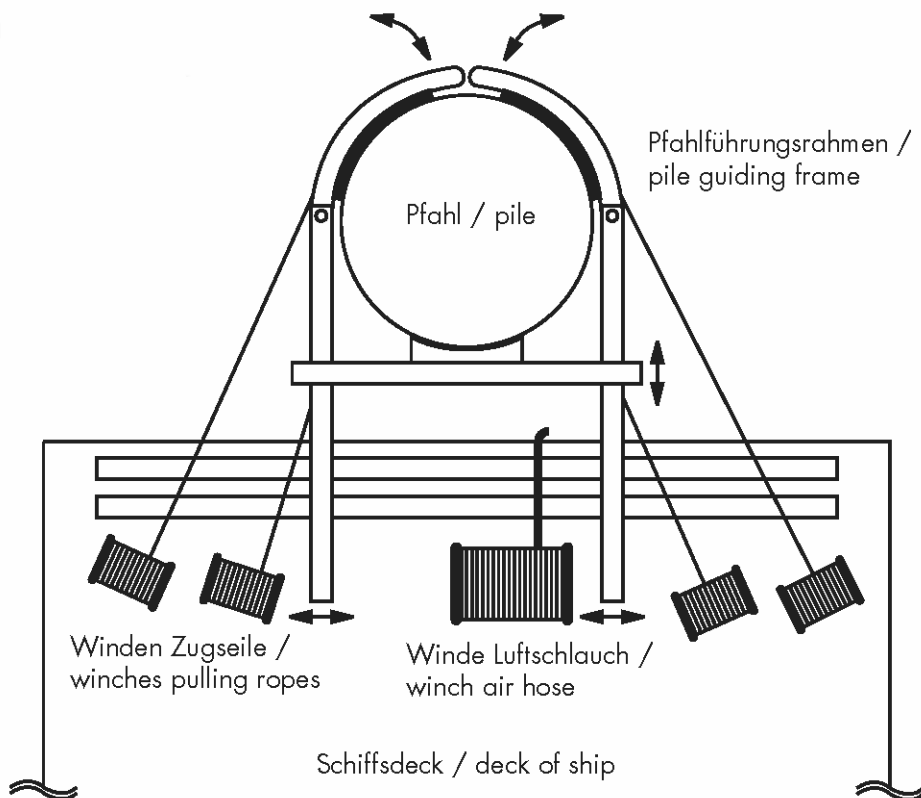
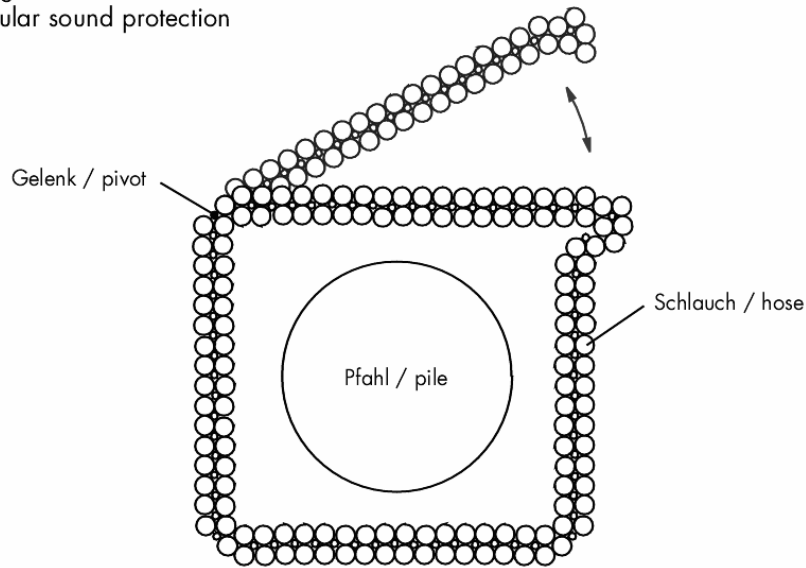

Figure 3-32. Top view: pile guiding frame with winches. Half-round guiding frame

Eckiger Schallschutz /
angular sound protection



Halbrunder Schallschutz /
half round sound protection

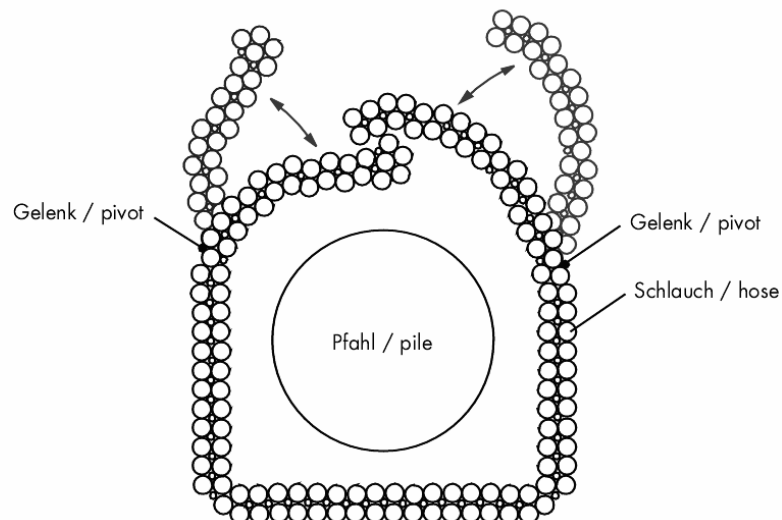

Figure 3-33. Top view of hose curtain

Time and cost impacts. Taking the described handling into consideration it is assumed that the use of the inflatable sleeve in conjunction with a barge piling frame will require 1-2 hours additional handling time per monopile depending on weather conditions and learning curve. On the construction of a wind farm and under optimum conditions, driving 2 piles every 3 days can be possible. An additional time of 1-2 hours corresponds to an increase of the total handling time per pile of 6 to 13%. With regard to the complete construction time (including installation of the nacelle etc.), the extra time for noise mitigation measures is less than 3%.

The combination of the barge piling frame and an attached inflatable sleeve under water noise reduction system is patented by MENCK. Commercially, once the final design is ready, such an inflatable sleeve system could become a project tool to be hired out on a time charter basis together with the hammer. The assembly of the inflatable sleeve would require project specific design depending on the design of the provided piling frame. Beside the transport, the mobilization and assembly time of the sleeve is estimated with 1-2 weeks in advance to the sail out of the construction vessel/barge/jack-up.

Regarding the costs, first of all the final design has to be engineered, preferably with an internal diameter of approx. 6.0 m to cover piles up to 5.0 m, depending on the outer dimensions of the hammer pile sleeve. Further it could be imagined that the inflatable sleeve system will either be hired out e.g. together with the piling hammer equipment or the sleeve system has to be purchased. In case of out hiring, currently the costs for rental are based on time charter and are estimated in the same rental range as the hammer equipment, depending on the overall rental duration.

The sales costs of such an inflatable sleeve system excl. piling frame currently estimated at EUR 2,500,000 to 3,000,000. Costs per pile when constructing a whole wind farm are estimated to be about EUR 20,000. However, more detailed engineering and supplier evaluation is necessary to specify the costs more in detail. The estimate is based on prices for some relatively expensive key components:

- a) Winches for pulling ropes and hose
- b) Ballast ring with air ring and remotely controlled air valves
- c) Inflatable hoses and their horizontal interconnections
- d) Hydraulic pivot mechanism in the ballast ring and in the upper support ring
- e) Pulleys for pulling ropes for carrying a total weight of 40-60 tons

The lifetime of the inflatable sleeve is targeted with at least 3 to 5 years including proper maintenance to increase the life time as good as possible.

The outlook for using the inflatable sleeve system in future for e.g. 6.0 m monopiles requires a dimensional upgrade of the described inflatable sleeve system after gaining experiences on a smaller scale. Depending on engineering modifications and suppliers capabilities, an upgrade of the principle is conceivable, whereby the cost impact is not yet predictable.

3.4.4 Possible technical realisation B: Telescopic tube

Design. The construction is shown schematically in Figure 3-34. The tube consists of a double-wall steel tube with the interspace filled with foam. The tube is divided into 3 to 5 segments to ease transport and to make the system adaptable to different water depths. With 5 segments of 5 m length, a water depth of 25 m is feasible. The purpose of the inner tube of each segment is to stabilise and protect the foam filling; a wall thickness of 5 mm steel is sufficient. The outer tube adds stability to the structure and has a wall thickness of 10 mm. A minimum steel mass is also needed to compensate for the foam's buoyancy.

With 5 segments, an inner diameter of 6 m (suitable for piles of 5 m diameter) and a 100 mm foam layer, the total weight of the telescopic tube will be 65-70 tons in air. The buoyancy of the foam will be 47-50 tons.

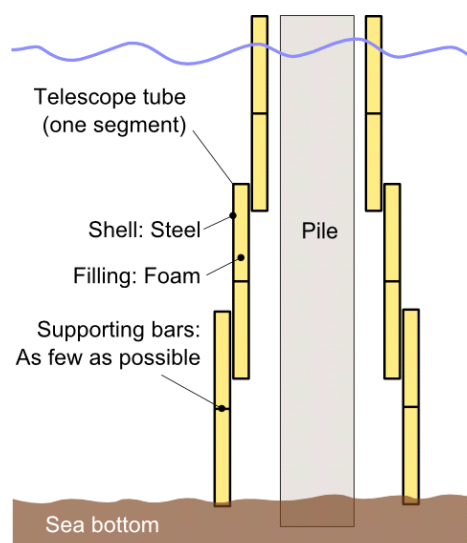

Figure 3-34. Telescopic noise mitigation tube (schematically, not to scale)

Handling procedure. The telescopic noise mitigation tube will be transported to the construction site on the working platform, i.e. the piling barge or jack-up. There are two possibilities:

- a) The telescopic tube is transported on deck and will be placed on the sea bottom with a crane. This requires a crane of sufficient capacity.
- b) The telescopic tube is mounted underneath the piling frame. No crane for deployment and adjustment is necessary, however the crane for handling the pile must be high enough to lift the pile completely out of the water to insert it into the piling frame. The work steps for variant a) are as follows:
 1. Position piling barge at the location
 2. Release sea fastenings of crane, noise mitigation tube, hammer, etc.
 3. Lift noise mitigation tube and deposit it on the sea bottom
 4. Connect the telescopic system with winches via pulleys at the piling frame
 5. Move pile into the piling frame and lower it into the tube on the sea bottom
 6. Fix and adjust pile in the piling frame
 7. Extend telescopic tube by means of the winches
 8. Drive pile to final depth
 9. Release telescopic tube
 10. Remove piling frame
 11. Lift telescopic tube and place it on deck

Work steps for the "craneless" variant b) are:

1. Position piling barge at the location
2. Release sea fastenings of crane, hammer, etc.
3. Position piling frame with integrated noise mitigation tube above location
4. Lift pile into piling frame (and into telescopic tube) and lower it to the sea bottom
5. Fix and adjust pile in the piling frame
6. Extend telescopic tube to full length by means of the winches
7. Drive pile to final depth
8. Lift telescopic tube

Method b) would be only applicable if the upper end of the pile, after it has been driven to its target penetration depth, does not extend too high above the water level. Furthermore, there must be enough space between the oiling gate and the water surface when the platform is transported. As this results in clear disadvantages against mounting an inflatable sleeve underneath the piling gate, focus will be laid on method a).

Time and cost impacts. If the telescopic noise mitigation tube is applied, the time needed to install a monopile – considering the whole installation process - will increase by about 20% from 1 to 1.2 days. This estimate is based on the construction of a complete windfarm, thus, if this time demand cannot be compensated, total time needed to construct a windfarm might increase by 20% as well.

One noise mitigation tube is considered to be sufficient for the construction of a complete offshore windfarm, but of course the number depends on the number of installation devices (barges, cranes, hammers). Furthermore it depends on the durability of the tube. It is suggested to carry an additional tube as back-up.

The lifetime of the telescopic noise mitigation tube is limited by vibration and ground motion caused by the pile driving. A lifetime of at least 2 years is anticipated.

Estimated costs for installing a monopile when constructing a whole wind farm will be approximately EUR 25,000 higher than without noise mitigation methods. This number mainly results from the additional time need, which is, however, at present rather difficult to calculate. Manufacturing costs for the telescopic tube are estimated at about EUR 600,000; this does not include winches and other auxiliary devices.

3.5 Assessment and need for further development

The investigations and analysis carried out in this project lead immediately to the result, that the initially requested "off the shelf" method to mitigate underwater noise from offshore pile driving is not available. Both the classical bubble curtain and the confined bubble curtain appear not to be suited for the offshore environment. The main reason for this is prevailing currents in tidal waters in addition to the generally harsh offshore environment. The rise time of the bubbles is too slow to cope with tidal currents, thus an unconfined bubble curtain would require large capacities of air conditioning compressors. Although large bubble curtains of almost 1 km length have been installed as oil barriers, this technique is, at this stage, considered not to be applicable in offshore conditions as both space and power supply are apparently limited on the construction platforms. In addition, the main requirement to maintain a closed curtain, cannot be guaranteed in tidal waters where bubbles would have to rise over a distance of 70 m and more to reach the surface. A simple confined bubble curtain, where air is released between the pile and a flexible fabric, is neither considered to be suitable because the current will press the fabric against the pile and thus allow an unrestricted propagation of noise. Both methods, which have been successfully applied in harbour works, are thus considered not to be applicable for offshore pile driving.

Modification of the piling hammer and other measures to prolong stroke duration and thereby reduce peak noise levels are also not regarded to be applicable at the moment. There are some general concerns from the industry and more experimental work is needed before planning any steps towards a practical realization.

On the other hand, recent experimental and theoretic studies as well as applications of noise mitigation measures in the practice clearly reveal that a significant reduction of underwater noise from offshore pile driving is possible. The main principle is the same in all methods: as much air as possible is confined around the noise source in order to attenuate sound propagation. As bubble curtains are problematic, the air has to be kept in a carrier, which may be either a tube of steel or other material coated or filled with foam, or an inflatable sleeve. This will achieve a much better attenuation than bubble curtains. The only, but important, function of the carrier is to withstand the currents and keep the foam in place, thus ensuring a closed noise barrier around it. The inflatable sleeve essentially fulfils the same task. The calculations presented in Figs. 3-22 and 3-23 indicate that a sufficient attenuation can be achieved not only in the high frequencies but also in the lower ranges, where sound levels are strongest.

The report identifies two methods which offer sufficient prospect for a technical realization in the practice: the inflatable sleeve and the telescopic tube, which would bring layers of air or foam around the pile. In Tab. 3-2 shows different levels of sound attenuation which could be reached implementing the described methods. Sound levels in 500 m are attenuated by 15 or 20 dB respectively and the radius in which harmful or disturbing effects on marine mammals may be expected is reduced considerably. The 180 dB radius is chosen as a proxy where harmful effects (physical impairment) may occur and the 140 dB radius likewise as a proxy for disturbance. The results indicate a considerable reduction of both zones. The area where a noise level of 140 dB may be exceeded would be reduced from about 2400 km² to 300 km² or 150 km² when using mitigation measures. Both methods are thus considered to be efficient in mitigating relevant noise levels.

Tab. 3-2: Predicted sound levels of a 6.5 m monopile with and without noise mitigation measures. As propagation models result in very large radii for the 140 dB level, the calculation are based on measurements on sound propagation from Amrumbank West (ISD et al. 2007).

	Without noise mitigation (Table 2.4)	Telescopic tube (attenuation 15 dB)	Inflatable sleeve (attenuation 20 dB)
Peak in 500 m	204 dB	189 dB	184 dB
SEL in 500 m	178 dB	163 dB	158 dB
180 dB SEL radii	400 m	40 m	20 m
140 dB SEL radii	25-30 km	10 km	7 km

Assessing the potential of the two selected approaches has to consider whether or not they can be applied in the practice of offshore pile driving. As the working plans for offshore pile driving and specific constructions at the platforms vary between projects, each methods has to be modified to fit to a certain piling strategy. The inflatable sleeve offers at present the most promising opportunities in this respect, as a permanent installation underneath the piling gate offers the best integration into other working processes. As long as the piling gate is capable of carrying the additional weight, which appears to be feasible, little additional installations on the working platform are needed. The overall effect on the working schedule is considered to be low. As the system has not yet been tested in experiments there is, however, a little uncertainty about the achievable level of attenuation and modification of the layer thickness may be required.

Calculations of the sound attenuation of the telescopic tube are based on experimental measures and are considered to be robust. Uncertainties about his method mainly remain towards its applicability under offshore conditions. The main challenge will be to position the telescopic tube exactly under the piling gate and insert the monopile into it as this may increase the height, the monopile has to be lifted to bring it into an upright position. The applicability of this method may thus be more restricted than the inflatable sleeve and may have stronger interference with piling operation. The main difference between the two methods in this respect is that the installation of the inflatable sleeve can be carried out in the harbour and will not interfere with the piling process, whereas the telescopic tube has to be placed on the spot at sea and be thus more time constrained and more susceptible in harsh weather conditions.

First estimates of the costs associated with the noise mitigation measures result at about 20,000 – 25,000 € per pile. The fact, that the costs of the inflatable sleeve are more on the side of the construction of the sleeve, whereas the costs of the telescopic tube are more on the side of the handling at sea, there is a higher uncertainty in the costs of using the telescopic tube. A statement as to whether or not this can be regarded as cost effective cannot be made at the moment. In this respect cost of noise mitigation can be balanced against the total costs of pile driving or the construction of an offshore windfarm. As offshore construction works are notoriously time constrained by weather conditions, any delay may result in a prolongation of the construction process, causing considerable additional costs, which are not included in the calculation. In addition, costs of noise mitigation may be compared to the costs of other solutions. Damage to marine mammals may also be avoided by deterring these animals out of the zone where injuries may be expected. This would include the use of acoustic deterrents and a monitoring program to control for presence and absence of marine mammals in the risk area. At present, it is not possible to compare costs and efficiency of these approaches, however, as noise mitigation would be effective in much larger areas, they are considered to be of greater benefit to marine wildlife. Noise mitigation measures are the only possibility to prevent harmful effects on fish, which cannot be deterred out of the critical zone.

4. Recommendations

This report identifies two methods which are promising to be both applicable and effective in reducing underwater noise arising from offshore pile driving. Both methods are considered to be generally compatible with the working processes in offshore pile driving. They could be brought into practice within a few months which would be needed to finally design and construct the devices. First estimates of the costs are in the same order of magnitude for both methods, but the risks of the methods are not equally distributed. The finding that the inflatable sleeve will be less demanding on the construction process at sea, considering both the infrastructure at the platform and the time schedule of pile driving, leads to a favouring of this method. However, at present it is too early for a final conclusion and both methods deserve further investigations.

The main recommendation of this report is thus to go ahead with further work to develop noise mitigation measures in order to make them ready for practice as soon as possible. It is recommended to conduct further work and experiments in the following aspects:

Construction

For both methods, suitable materials have to be selected and manufactured in order to construct the needed devices. This will require quite some engineering work. In the case of the inflatable sleeve, the exact dimensions and many aspects of the design have to fit to the construction and operation of the piling gates at the construction platform, which in turn must be suited for the additional load.

Operation

Operation of the noise mitigation devices is a very important part of the whole process and further work is needed to plan their implementation into the working processes. This can at first hand been done by analysing detailed construction schedules of offshore pile driving and estimates of the time needed to bring the mitigation measures into place.

Costs

Costs have to be calculated in more detail both in relation to the construction of the devices and in relation to the handling at sea. Any impacts on the total construction time of a windfarm have to be taken into account.

Acoustic efficiency

The attenuation reached by the mitigation measures should be tested experimentally in smaller dimensions before these are brought into practice. From the experiments, a better knowledge on actual attenuation and thus important feedback on the construction of the devices is expected. This holds especially true for the inflatable sleeve of which theoretical analysis indicate a rather high efficiency, which still has to be proven in experimental tests.

Biological significance

A most important issue will be to investigate the biological significance of underwater noise of pile driving both with and without noise mitigation measures. So far, only one study has addressed the effects of offshore pile driving on harbour porpoises. For other species, no data are available yet. Noise mitigation measures are recommended as a precaution, however, both the need to use them as well as their efficiency to protect marine wildlife should be subject of detailed investigations as a base for an intended program for reducing underwater noise.

Recommendations for a program for reducing underwater noise

COWRIE has requested the contractors of this report to make recommendations for a program for reducing underwater noise. From the present state of knowledge it appears that noise mitigation measures, although further efforts have to be made to reach a final engineering solution, offer a promising opportunity to reduce underwater noise efficiently and thus be of great benefit to marine wildlife. From a precautionary point of view and without balancing any impacts on costs and construction schedule, their application in offshore pile driving is highly recommended. Also for the offshore industry, noise mitigation may prove to be beneficial as their application may allow construction works in areas and times when restrictions are needed to protect sensitive species. However, in order to develop a program for reducing underwater noise there is clearly a need for criteria to define under which circumstances noise mitigation measures are needed and which level of attenuation has to be achieved. These criteria would have to balance both conservation needs and the demands entailed with constructing offshore windfarms. Basically, two sets of criteria are needed: First, criteria determining noise levels which are considered to be acceptable to avoid physical damage and reduce disturbance to sensitive species. Second, criteria determining under which conditions noise mitigation measures have to be applied. This should take the density of endangered or sensitive species in a given area into account.

Further aspects

This report has focussed on the construction of monopile foundation for offshore wind turbines only. As there are more types of foundations for offshore wind turbines as Tripod and Jacket types which require different ways of construction and as there are many more types of constructing offshore facilities, the report touches only one source of noise which may be relevant to marine wildlife. It would be valuable to investigate the possibilities to mitigate the noise from other construction techniques as well.

5. References

- Betke, K., Schultz-von Glahn, M., Petersen, A., Gabriel, J. (2003): Messung der Unterwasser-Schallabstrahlung einer Offshore-Windenergieanlage. In: Fortschritte der Akustik – DAGA'03, 322-323. Deutsche Gesellschaft für Akustik DEGA
- Betke, K., Schultz-von Glahn, M., Matuschek, R. (2004): Underwater noise emissions from offshore wind turbines. In: Proceedings of the joint congress CFA/DAGA'04, 591-592, Strasbourg
- Betke, K., Schultz-von Glahn, M. (2006): Minderung von Unterwasserschall bei Offshore-Rammarbeiten. In: Fortschritte der Akustik – DAGA'06, 439-440. Deutsche Gesellschaft für Akustik (DEGA)
- BMT Cordah (2003): Offshore Wind Energy Generation: Phase 1 Proposals and Environmental Report. Report to DTI
- CRI, DEWI, ITAP (2004): Standardverfahren zur Ermittlung und Bewertung der Belastung der Meeresumwelt durch die Schallimmission von Offshore-Windenergieanlagen. Project 0327528A final report. The German Federal Environment Ministry
- Elmer, K. (2007): Schallemissionen beim Rammen von Offshore-Fundamenten. 2nd Scientific Conference on the Use of Offshore Wind Energy. Federal Environment Ministry, Berlin, 20-21 February
- Fay, R.R. (1988): Hearing in vertebrates, a psychophysics databook. Hill-Fay Associates, Winneteka, IL
- Hildebrand, J. (2006): Impacts of anthropogenic sound on cetaceans. IWC/SC/56/E13
- ISD, DEWI, ITAP (2007): Standardverfahren zur Ermittlung und Bewertung der Belastung der Meeresumwelt durch die Schallimmission von Offshore-Windenergieanlagen. Project 0329947 final report. The German Federal Environment Ministry
- Illingsworth & Rodkin, Inc. (2001): Noise and Vibration Measurements Associated with the Pile Installation Demonstration Project for the San Francisco-Oakland Bay Bridge East Span. Final Data Report, Appendix D-8901
- Jensen, F.B., Kuperman, W.A., Porter, M.B., Schmidt, H. (1994): Computational Ocean Acoustics. AIP Press, Woodbury, New York
- Kastelein R.A., Brunskoek, P., Hagedoorn, M. (2002): Audiogram of a harbor porpoise (*Phocoena phocoena*) measured with narrow-band frequency-modulated signals. *J. Acoust. Soc. Am.* **112**, 334-344
- Kastelein, R.A., Verboom, W.C., Muijsers, M., Jennings, N.V. and van der Heul, S. (2005): The influence of acoustic emissions for underwater data transmission on the behaviour of harbour porpoises (*Phocoena phocoena*) in a floating pen. *Mar. Env. Res.* **59**, 287-307.
- Kastelein, R.A., Sander, S. Van der, Verboom, W.C., Triesscheijn, R. J. V., & Jennings, N.V. (2006): The influence of underwater data transmission sounds on the displacement behaviour of captive harbour seals (*Phoca vitulina*) in a floating pen. *Mar. Env. Res.* **61**, 19-39.
- Ketten, D. & Finneran, J. (2004): Noise exposure criteria: „Injury (PTS) criteria“. In: R. Gentry: Presentation at the Second Plenary Meeting of the Advisory Committee on Acoustic Impacts on Marine Mammals. Arlington, Virginia, 28-30 April 2004.
- Leifer, I. (2000): A Study on the Temperature Variation of Rise Velocity for Large Clean Bubbles. *J. Atmos. Oceanic Technol.* **17**, 1392-1402
- Lotze, E. (1996): Schallschutzkapseln. In: Schirmer, W. (Ed.), Technischer Schallschutz. VDI-Verlag, Düsseldorf
- Lucke, K., LEpper, P. A., Blanchet, M.-A. & Siebert., U. (2007): Testing the auditory tolerance of harbour porpoises hearing for impulsive sounds. Poster at International Conference The Effects of Noise on Aquatic Life, borg Denmark, August 13th to 17th 2007.
- Madsen, P. T. Wahlberg, M., Tougaard, J., Lucke, K. & Tyack, P. (2006): Wind turbine underwater noise and marine mammals: implications of current knowledge and data needs. *Mar. Ecol. Prog. Ser.* 309: 279-295
- Medwin, H. (2005): Sounds in the Sea. Cambridge University Press, Cambridge
- Nedwell, J.R., Edwards, B., Turnpenny, A.W.H. & Gordon, J. (2004). Fish and marine mammal audiograms: a summary of available information. Subacoustech report ref. 534R0214, submitted to Chevron Texaco Ltd.: 278 pp.

- Nedwell, J.R., Langworthy, J., Howell, D. (2003): Assessment of sub-sea acoustic noise and vibration from offshore wind turbines and its impact on marine wildlife; initial measurements of underwater noise during construction of offshore windfarms, and comparison with background noise. Subacoustech Report No. 544R0424 commissioned by COWRIE
- Parvin, S.J., Nedwell, J.R., Workman, R. (2006a): Underwater noise impact modelling in support of the London Array, Greater Gabbard and Thanet offshore wind farm developments. Subacoustech Report No. 710R0515
- Parvin, S.J., Nedwell, J.R. (2006b): Underwater noise survey during impact piling to construct the Burbo Bank Offshore Wind Farm. Subacoustech Report No. 726R0103. Interim report for COWRIE project no. ACO-04-2002
- Petrie, F.S. (2005): Washington State Ferries' Experience with Bubble Curtains: Purpose, Hardware, and Use. 2005 Summer Meeting/Conference of the Transportation Research Board ADC40 (A1F04) Noise & Vibration Committee
- Popper, A. N., Carlson, T. J., Hawkins, A. D., Southall, B. L. & Gentry, R. L. (2006): Interim Criteria for Injury of Fish Exposed to Pile Driving Operations: A White Paper. Statement to Washington State Department of Transport, http://www.wsdot.wa.gov/NR/rdonlyres/84A6313A-9297-42C9-BFA6-750A691E1DB3/0/BA_PileDrivingInterimCriteria.pdf
- Reyff, J.A. (2003): Underwater sound pressures associated with the restrike of the pile installation demonstration project piles. Report prepared by Illingworth & Rodkin, Inc. for State of California, Department of Transportation
- Richardson, W. J., Green, C. R., Malme, C. I. & Thomson, D. H. (1995): Marine mammals and noise. Academic Press
- Schultz-von Glahn, M., Betke, K., Nehls, G. (2006): Underwater noise reduction of pile driving for offshore wind turbines – Evaluation of several techniques under offshore conditions. UFOPLAN Ref. No. 205 53 113, final report. The Federal Environment Agency (Umweltbundesamt), Berlin, <http://www.itap.de/uba-20553113.pdf>
- Shepherd, B. (2006): Underwater Noise Impact Assessment on Marine mammals and Fish during Pile Driving of proposed Round 2 Offshore Wind Farms in the Thames Estuary. RPS Energy, Report No. EOR0523
- SMRU Ltd (Sea Mammal Research Unit) (2007): Assessment of the potential for acoustic deterrents to mitigate the impact on marine mammals of underwater noise arising from the construction of offshore windfarms. Commissioned by COWRIE Ltd (project reference DETER-01-07).
- Southall, B., Schusterman, R. J., Kastak, D. & Reichmuth, C. R. (2005): Reliability of underwater hearing thresholds in pinnipeds. Acoustic Research Letters Online, 14. Juli 2005.
- Southall, B. L., Bowles, A. E., Ellison, W. T., Finneran, J. J., Gentry, R. L., Greene, C. R. Jr., Nachtigall, P. E., Richardson, W. J., Thomas, J. A. & Tyack, L. T. (2007): Marine mammal noise-exposure criteria: Initial Scientific recommendations. **Abstract**, International Conference The Effects of Noise on Aquatic Life, borg Denmark, August 13th to 17th 2007..
- SURTASS (2007): Final Supplemental Environmental Impact Statement for Surveillance Towed Array Sensor System Low Frequency Active (SURTASS LFA) Sonar. US Department of the Navy, www.surtass-lfa-eis.com
- Thomsen, F., Lüdemann, K., Kafemann, R. and Piper, W. (2006): Effects of offshore wind farm noise on marine mammals and fish. biola, Hamburg, Germany on behalf of COWRIE Ltd.
- Tougaard J, Carstensen J, Henriksen OD, Skov H, Teilmann J (2003) Short-term effects of the construction of wind turbines on harbour porpoises at Horns Reef. Technical report to Techwise A/S, HME/362-02662. Hedeselskabet, Roskilde. Also available at: www.hornsrev.dk
- Tougaard, J., Madsen, P.T & Wahlberg, M. (2007): Underwater noise from construction and operation of offshore wind farms. **Abstract**, International Conference The Effects of Noise on Aquatic Life, borg Denmark, August 13th to 17th 2007.
- Urlick, R. (1983): Principles of underwater sound, 3rd ed. Pensinsula Publishing, Los Altos
- Vagle, S. (2003): On the Impact of Underwater Pile-Driving Noise on Marine Life. Institute of Ocean Sciences, DFO/Pacific, Ocean Science and Productivity Division
- Würsig, B. Greene, C.R, Jefferson, T.A. (2000): Development of an air bubble curtain to reduce underwater noise of percussive piling. Mar. Environ. Res. **49**, 79-93